

Excellent Integrated System Limited

Stocking Distributor

Click to view price, real time Inventory, Delivery & Lifecycle Information:

[Infineon Technologies](#)

[SKP04N60](#)

For any questions, you can email us directly:

sales@integrated-circuit.com



SKP04N60

Fast IGBT in NPT-technology with soft, fast recovery anti-parallel Emitter Controlled Diode

- 75% lower E_{off} compared to previous generation combined with low conduction losses
- Short circuit withstand time – 10 μ s
- Designed for:
 - Motor controls
 - Inverter
- NPT-Technology for 600V applications offers:
 - very tight parameter distribution
 - high ruggedness, temperature stable behaviour
 - parallel switching capability
- Very soft, fast recovery anti-parallel Emitter Controlled Diode
- Pb-free lead plating; RoHS compliant
- Qualified according to JEDEC¹ for target applications
- Complete product spectrum and PSpice Models : <http://www.infineon.com/igbt/>

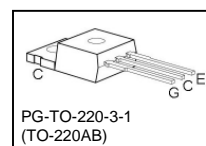
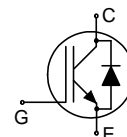

Type	V_{CE}	I_C	$V_{CE(sat)}$	T_j	Marking	Package
SKP04N60	600V	4A	2.3V	150°C	K04N60	PG-TO-220-3-1

Maximum Ratings

Parameter	Symbol	Value	Unit
Collector-emitter voltage	V_{CE}	600	V
DC collector current	I_C	9.4	A
$T_C = 25^\circ\text{C}$		9.4	
$T_C = 100^\circ\text{C}$		4.9	
Pulsed collector current, t_p limited by T_{jmax}	I_{Cpuls}	19	
Turn off safe operating area	-	19	
$V_{CE} \leq 600\text{V}, T_j \leq 150^\circ\text{C}$			
Diode forward current	I_F	10	
$T_C = 25^\circ\text{C}$		10	
$T_C = 100^\circ\text{C}$		4	
Diode pulsed current, t_p limited by T_{jmax}	I_{Fpuls}	19	
Gate-emitter voltage	V_{GE}	± 20	V
Short circuit withstand time ²	t_{SC}	10	μ s
$V_{GE} = 15\text{V}, V_{CC} \leq 600\text{V}, T_j \leq 150^\circ\text{C}$			
Power dissipation	P_{tot}	50	W
$T_C = 25^\circ\text{C}$			
Operating junction and storage temperature	T_j, T_{stg}	-55...+150	°C
Soldering temperature	T_s	260	°C
wavesoldering, 1.6 mm (0.063 in.) from case for 10s			

¹ J-STD-020 and JESD-022

² Allowed number of short circuits: <1000; time between short circuits: >1s.



SKP04N60

Thermal Resistance

Parameter	Symbol	Conditions	Max. Value	Unit
Characteristic				
IGBT thermal resistance, junction – case	R_{thJC}		2.5	K/W
Diode thermal resistance, junction – case	R_{thJCD}		4.5	
Thermal resistance, junction – ambient	R_{thJA}	PG-TO-220-3-1	62	

Electrical Characteristic, at $T_j = 25\text{ }^\circ\text{C}$, unless otherwise specified

Parameter	Symbol	Conditions	Value			Unit
			min.	Typ.	max.	
Static Characteristic						
Collector-emitter breakdown voltage	$V_{(BR)CES}$	$V_{GE}=0V, I_C=500\mu A$	600	-	-	V
Collector-emitter saturation voltage	$V_{CE(sat)}$	$V_{GE} = 15V, I_C=4A$ $T_j=25\text{ }^\circ\text{C}$ $T_j=150\text{ }^\circ\text{C}$	1.7 -	2.0 2.3	2.4 2.8	
Diode forward voltage	V_F	$V_{GE}=0V, I_F=4A$ $T_j=25\text{ }^\circ\text{C}$ $T_j=150\text{ }^\circ\text{C}$	1.2 -	1.4 1.25	1.8 1.65	
Gate-emitter threshold voltage	$V_{GE(th)}$	$I_C=200\mu A, V_{CE}=V_{GE}$	3	4	5	
Zero gate voltage collector current	I_{CES}	$V_{CE}=600V, V_{GE}=0V$ $T_j=25\text{ }^\circ\text{C}$ $T_j=150\text{ }^\circ\text{C}$	- -	- -	20 500	μA
Gate-emitter leakage current	I_{GES}	$V_{CE}=0V, V_{GE}=20V$	-	-	100	nA
Transconductance	g_{fs}	$V_{CE}=20V, I_C=4A$		3.1	-	S
Dynamic Characteristic						
Input capacitance	C_{iss}	$V_{CE}=25V,$ $V_{GE}=0V,$ $f=1\text{ MHz}$	-	264	317	pF
Output capacitance	C_{oss}		-	29	35	
Reverse transfer capacitance	C_{riss}		-	17	20	
Gate charge	Q_{Gate}	$V_{CC}=480V, I_C=4A$ $V_{GE}=15V$	-	24	31	nC
Internal emitter inductance measured 5mm (0.197 in.) from case	L_E		-	7	-	nH
Short circuit collector current ²⁾	$I_{C(SC)}$	$V_{GE}=15V, t_{SC}\leq 10\mu s$ $V_{CC}\leq 600V,$ $T_j\leq 150\text{ }^\circ\text{C}$	-	40	-	A

²⁾ Allowed number of short circuits: <1000; time between short circuits: >1s.



SKP04N60

Switching Characteristic, Inductive Load, at $T_j=25^\circ\text{C}$

Parameter	Symbol	Conditions	Value			Unit
			min.	typ.	max.	
IGBT Characteristic						
Turn-on delay time	$t_{d(on)}$	$T_j=25^\circ\text{C}$, $V_{CC}=400\text{V}$, $I_C=4\text{A}$, $V_{GE}=0/15\text{V}$, $R_G=67\Omega$, $L_{\sigma}^{(1)}=180\text{nH}$, $C_{\sigma}^{(1)}=180\text{pF}$ Energy losses include "tail" and diode reverse recovery.	-	22	26	ns
Rise time	t_r		-	15	18	
Turn-off delay time	$t_{d(off)}$		-	237	284	
Fall time	t_f		-	70	84	
Turn-on energy	E_{on}		-	0.070	0.081	mJ
Turn-off energy	E_{off}		-	0.061	0.079	
Total switching energy	E_{ts}		-	0.131	0.160	
Anti-Parallel Diode Characteristic						
Diode reverse recovery time	t_{rr}	$T_j=25^\circ\text{C}$, $V_R=200\text{V}$, $I_F=4\text{A}$, $di_F/dt=200\text{A}/\mu\text{s}$	-	180	-	ns
	t_s		-	15	-	
	t_F		-	165	-	
Diode reverse recovery charge	Q_{rr}		-	130	-	nC
Diode peak reverse recovery current	I_{rrm}		-	2.5	-	A
Diode peak rate of fall of reverse recovery current during t_b	di_{rr}/dt		-	180	-	A/ μs

Switching Characteristic, Inductive Load, at $T_j=150^\circ\text{C}$

Parameter	Symbol	Conditions	Value			Unit
			min.	typ.	max.	
IGBT Characteristic						
Turn-on delay time	$t_{d(on)}$	$T_j=150^\circ\text{C}$ $V_{CC}=400\text{V}$, $I_C=4\text{A}$, $V_{GE}=0/15\text{V}$, $R_G=67\Omega$, $L_{\sigma}^{(1)}=180\text{nH}$, $C_{\sigma}^{(1)}=180\text{pF}$ Energy losses include "tail" and diode reverse recovery.	-	22	26	ns
Rise time	t_r		-	16	19	
Turn-off delay time	$t_{d(off)}$		-	264	317	
Fall time	t_f		-	104	125	
Turn-on energy	E_{on}		-	0.115	0.132	mJ
Turn-off energy	E_{off}		-	0.111	0.144	
Total switching energy	E_{ts}		-	0.226	0.277	
Anti-Parallel Diode Characteristic						
Diode reverse recovery time	t_{rr}	$T_j=150^\circ\text{C}$ $V_R=200\text{V}$, $I_F=4\text{A}$, $di_F/dt=200\text{A}/\mu\text{s}$	-	230	-	ns
	t_s		-	23	-	
	t_F		-	227	-	
Diode reverse recovery charge	Q_{rr}		-	300	-	nC
Diode peak reverse recovery current	I_{rrm}		-	4	-	A
Diode peak rate of fall of reverse recovery current during t_b	di_{rr}/dt		-	200	-	A/ μs

¹⁾ Leakage inductance L_{σ} and Stray capacity C_{σ} due to dynamic test circuit in Figure E.



SKP04N60

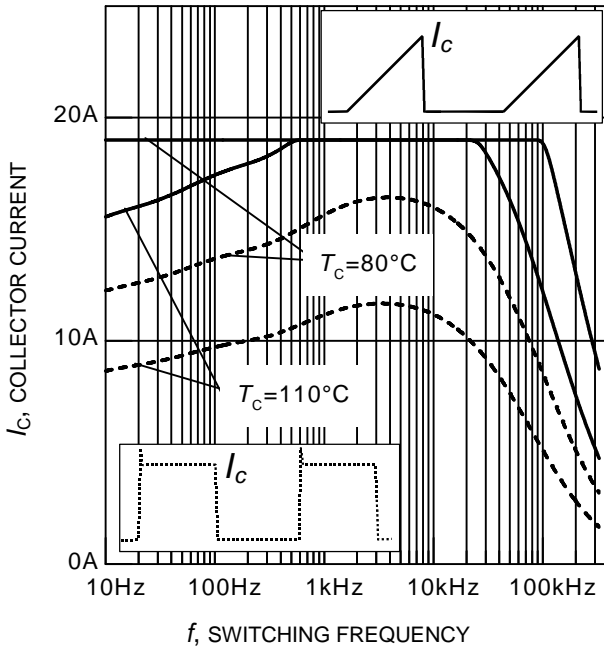

Figure 1. Collector current as a function of switching frequency
($T_j \leq 150^\circ\text{C}$, $D = 0.5$, $V_{CE} = 400\text{V}$, $V_{GE} = 0/+15\text{V}$, $R_G = 67\Omega$)

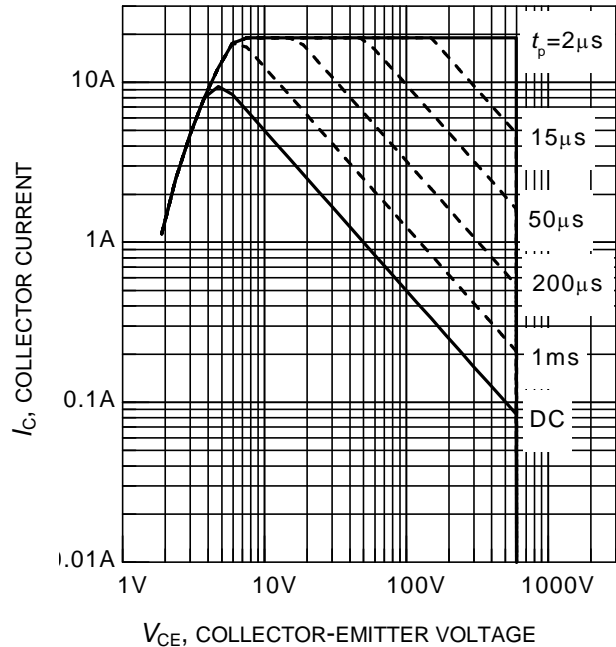

Figure 2. Safe operating area
($D = 0$, $T_C = 25^\circ\text{C}$, $T_j \leq 150^\circ\text{C}$)

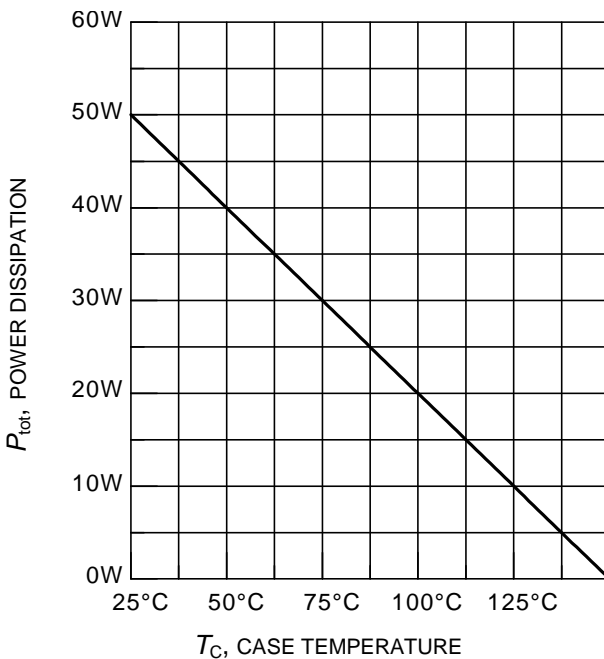

Figure 3. Power dissipation as a function of case temperature
($T_j \leq 150^\circ\text{C}$)

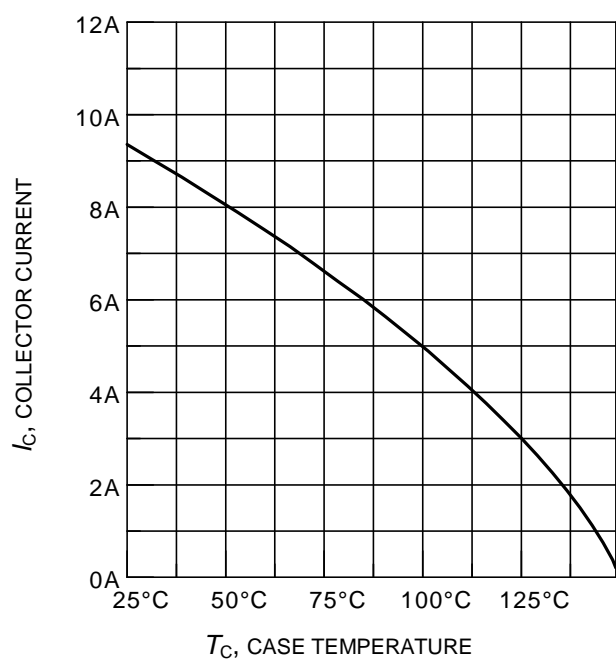

Figure 4. Collector current as a function of case temperature
($V_{GE} \leq 15\text{V}$, $T_j \leq 150^\circ\text{C}$)



SKP04N60

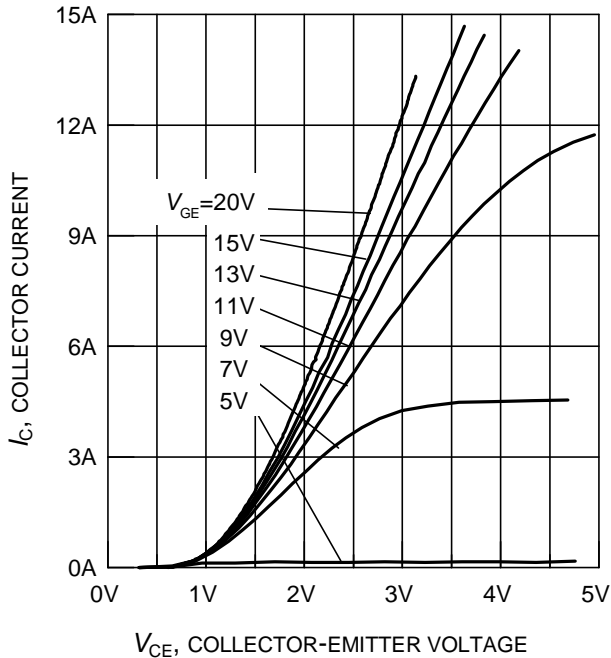

Figure 5. Typical output characteristics
($T_j = 25^\circ\text{C}$)

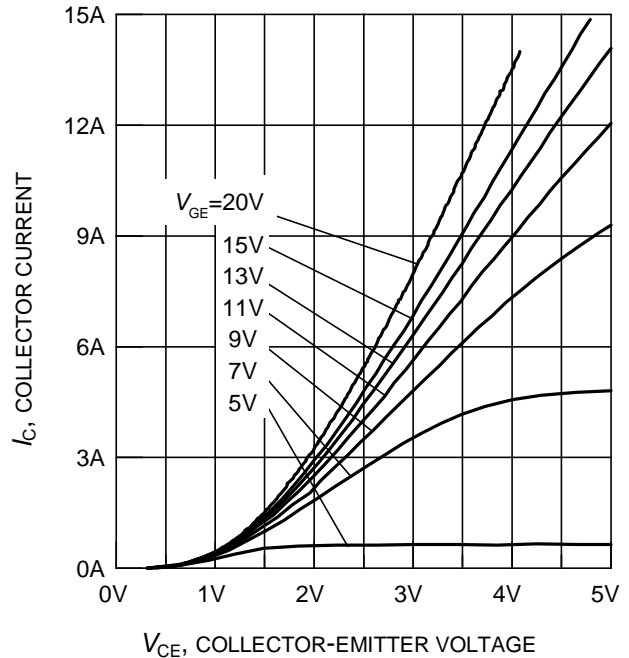

Figure 6. Typical output characteristics
($T_j = 150^\circ\text{C}$)

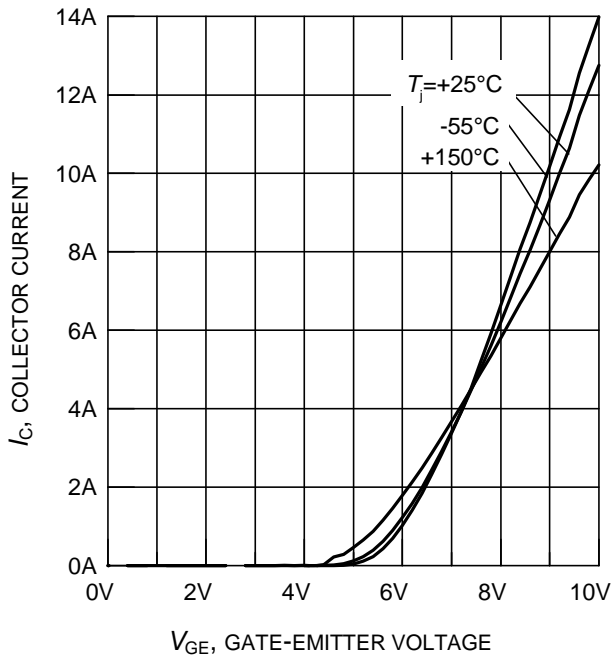

Figure 7. Typical transfer characteristics
($V_{CE} = 10\text{V}$)

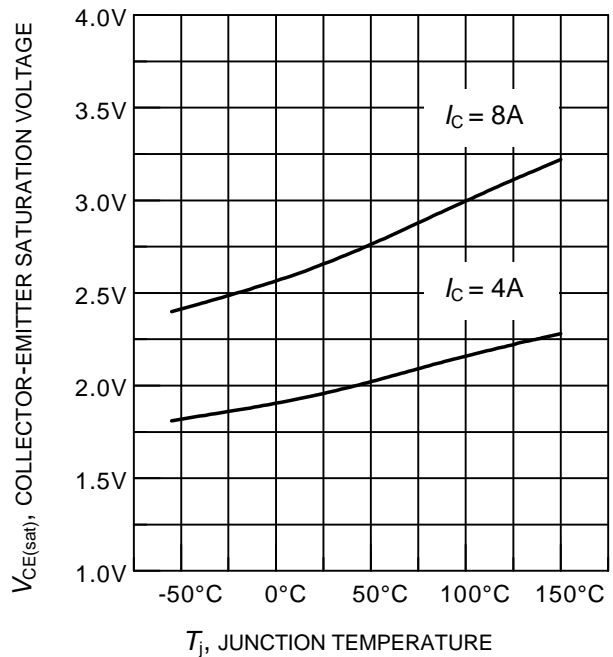

Figure 8. Typical collector-emitter saturation voltage as a function of junction temperature
($V_{GE} = 15\text{V}$)



SKP04N60

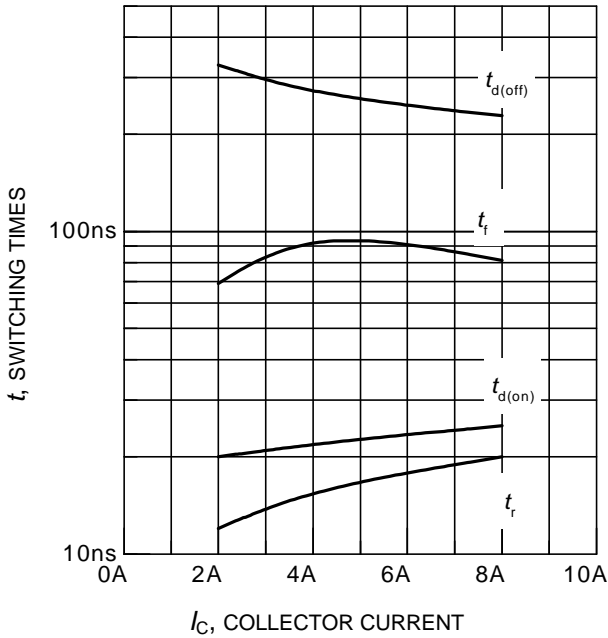

Figure 9. Typical switching times as a function of collector current
 (inductive load, $T_j = 150^\circ\text{C}$, $V_{CE} = 400\text{V}$, $V_{GE} = 0/+15\text{V}$, $R_G = 67\Omega$,
 Dynamic test circuit in Figure E)

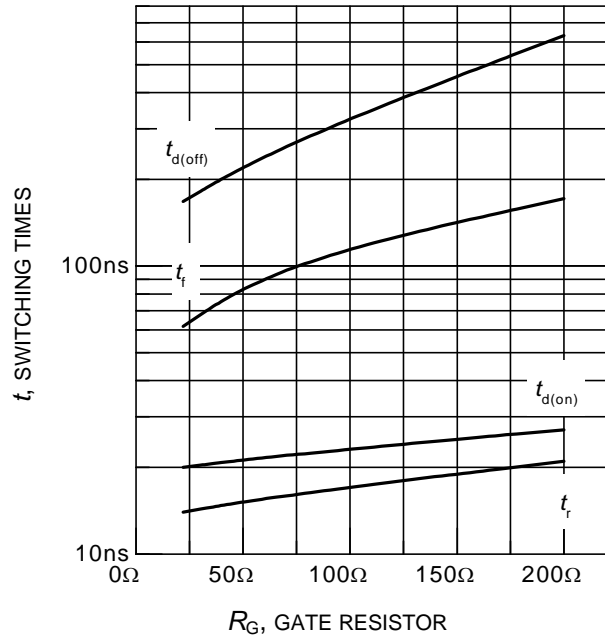

Figure 10. Typical switching times as a function of gate resistor
 (inductive load, $T_j = 150^\circ\text{C}$, $V_{CE} = 400\text{V}$, $V_{GE} = 0/+15\text{V}$, $I_C = 4\text{A}$,
 Dynamic test circuit in Figure E)

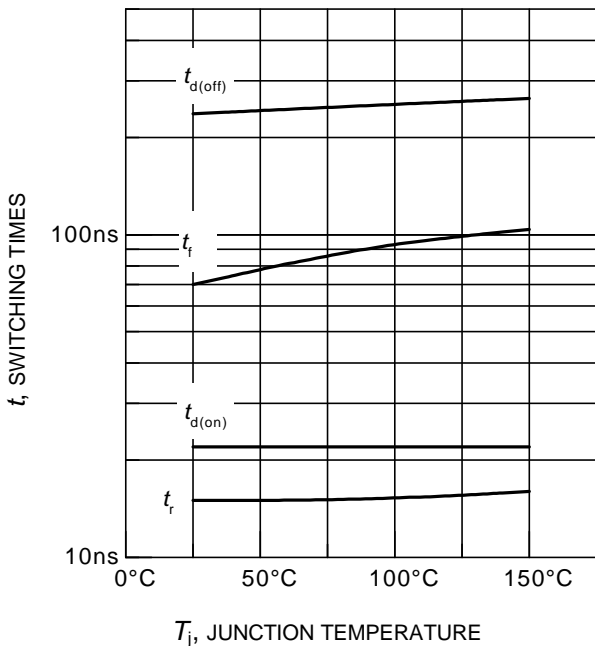

Figure 11. Typical switching times as a function of junction temperature
 (inductive load, $V_{CE} = 400\text{V}$, $V_{GE} = 0/+15\text{V}$, $I_C = 4\text{A}$, $R_G = 67\Omega$,
 Dynamic test circuit in Figure E)

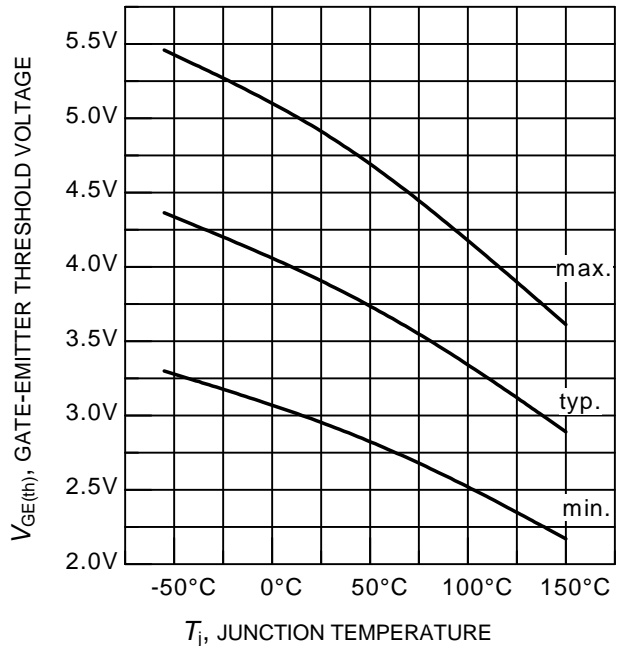

Figure 12. Gate-emitter threshold voltage as a function of junction temperature
 ($I_C = 0.2\text{mA}$)



SKP04N60

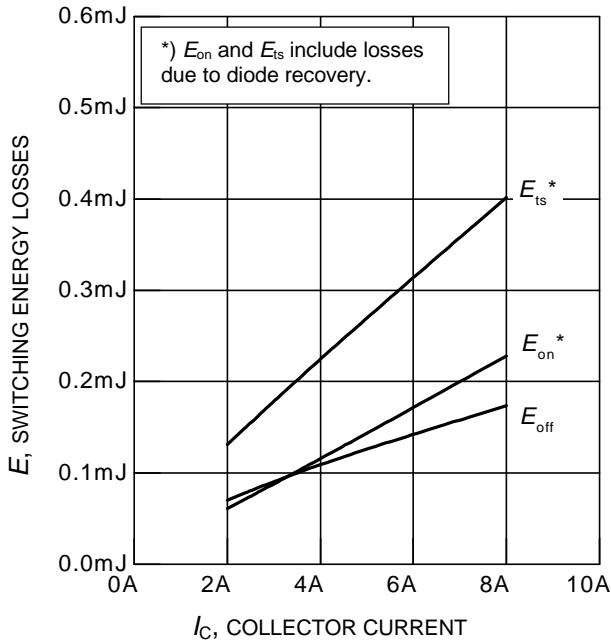

Figure 13. Typical switching energy losses as a function of collector current
(inductive load, $T_j = 150^\circ\text{C}$, $V_{CE} = 400\text{V}$, $V_{GE} = 0/+15\text{V}$, $R_G = 67\Omega$, Dynamic test circuit in Figure E)

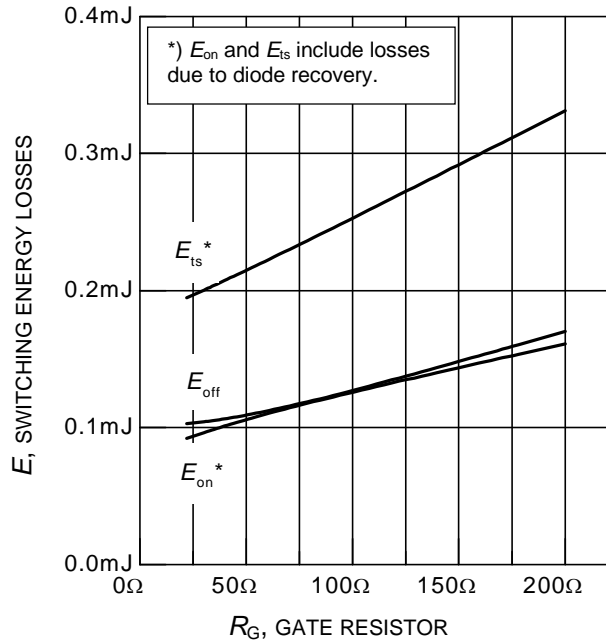

Figure 14. Typical switching energy losses as a function of gate resistor
(inductive load, $T_j = 150^\circ\text{C}$, $V_{CE} = 400\text{V}$, $V_{GE} = 0/+15\text{V}$, $I_C = 4\text{A}$, Dynamic test circuit in Figure E)

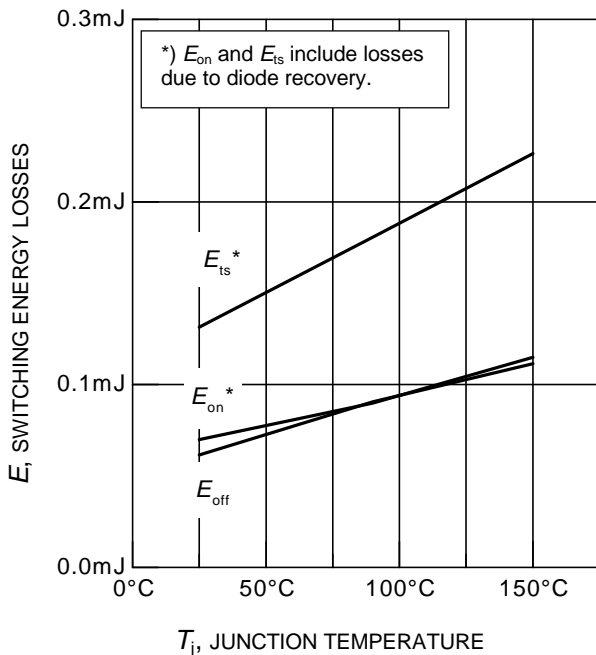

Figure 15. Typical switching energy losses as a function of junction temperature
(inductive load, $V_{CE} = 400\text{V}$, $V_{GE} = 0/+15\text{V}$, $I_C = 4\text{A}$, $R_G = 67\Omega$, Dynamic test circuit in Figure E)

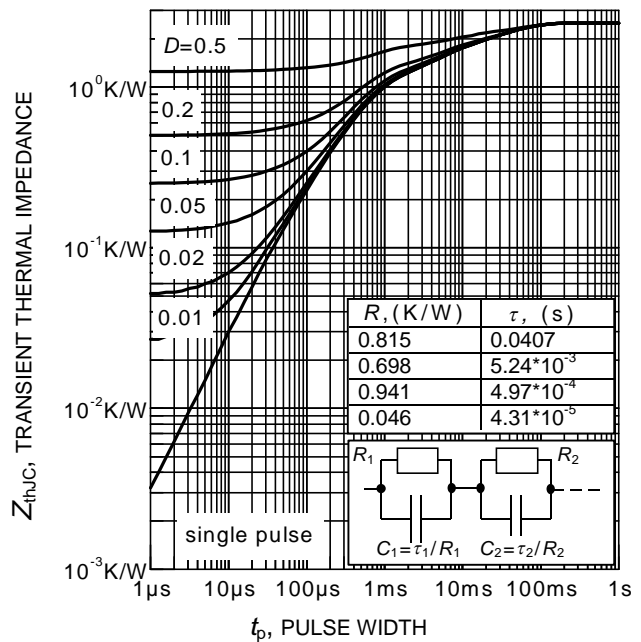

Figure 16. IGBT transient thermal impedance as a function of pulse width
($D = t_p / T$)



SKP04N60

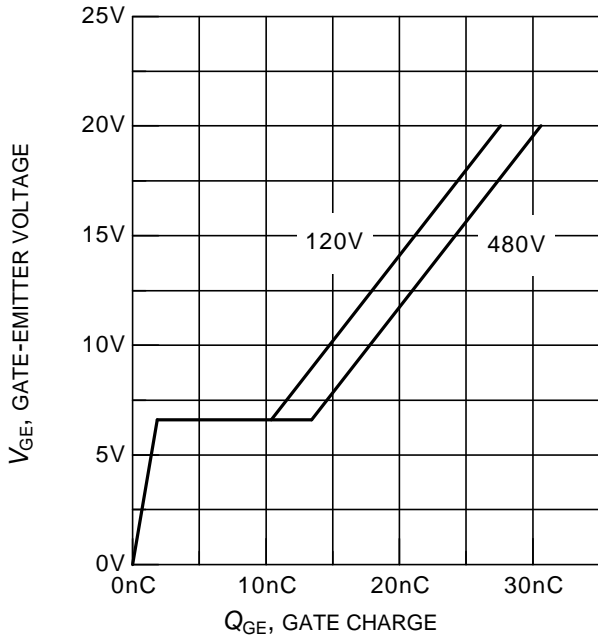

Figure 17. Typical gate charge
($I_c = 4A$)

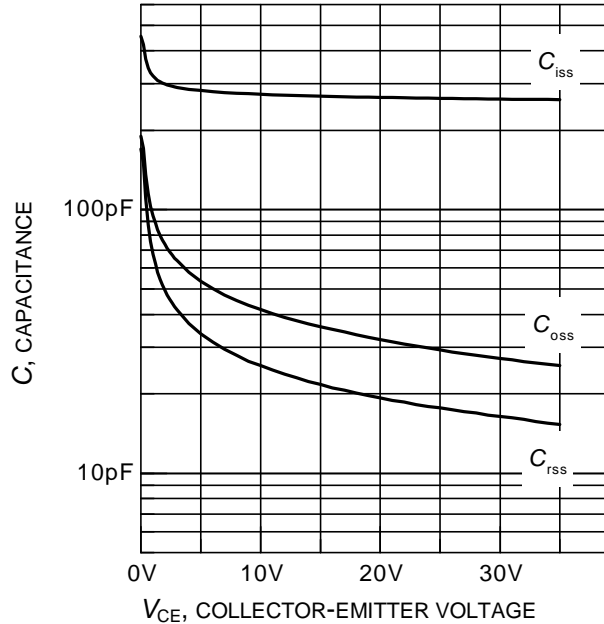

Figure 18. Typical capacitance as a function of collector-emitter voltage
($V_{GE} = 0V, f = 1MHz$)

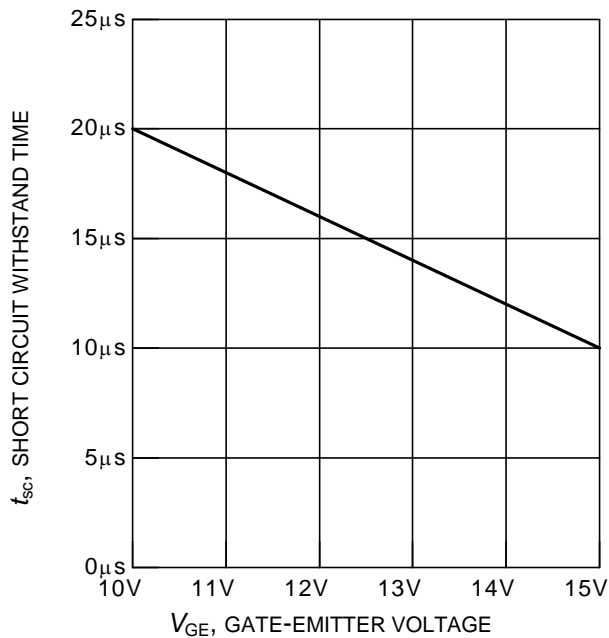

Figure 19. Short circuit withstand time as a function of gate-emitter voltage
($V_{CE} = 600V, \text{start at } T_i = 25^\circ C$)

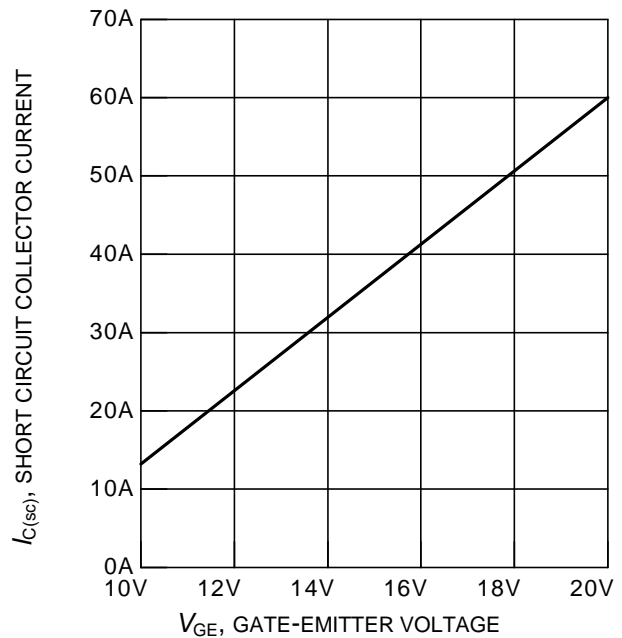

Figure 20. Typical short circuit collector current as a function of gate-emitter voltage
($V_{CE} \leq 600V, T_i = 150^\circ C$)



SKP04N60

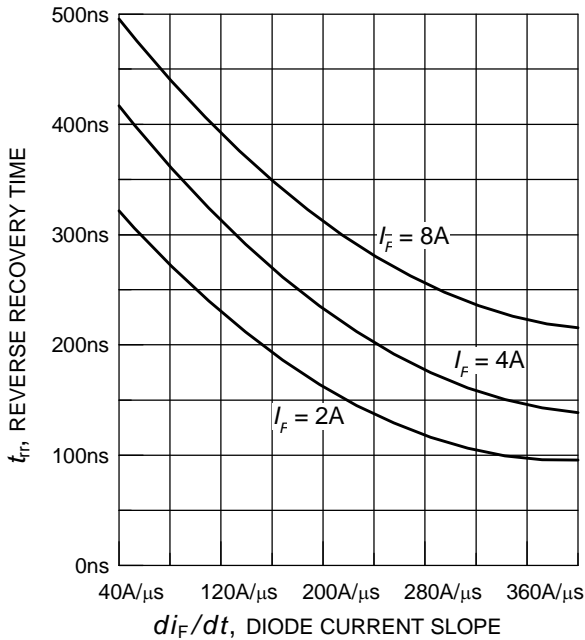

Figure 21. Typical reverse recovery time as a function of diode current slope
($V_R = 200V$, $T_j = 125^\circ C$,
Dynamic test circuit in Figure E)

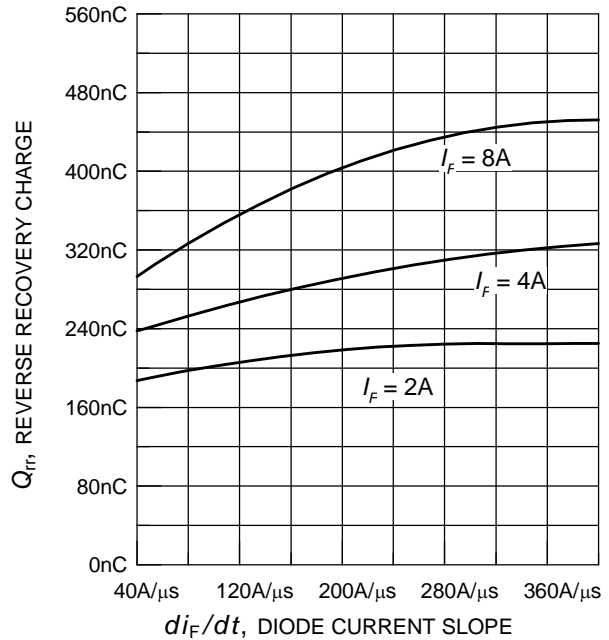

Figure 22. Typical reverse recovery charge as a function of diode current slope
($V_R = 200V$, $T_j = 125^\circ C$,
Dynamic test circuit in Figure E)

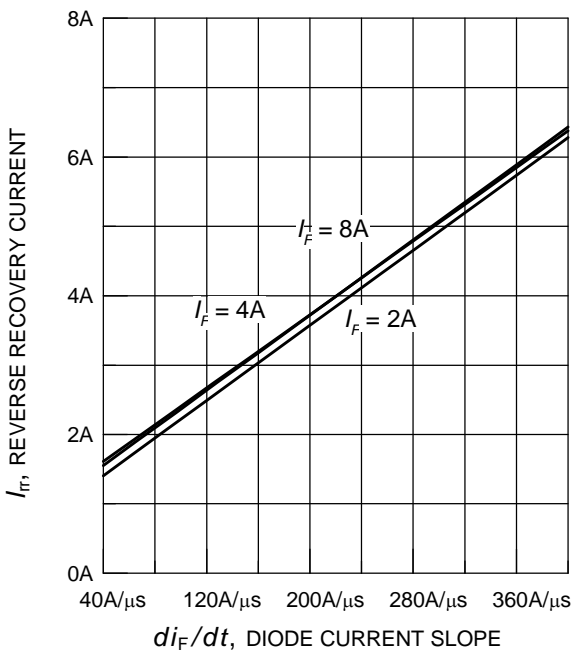

Figure 23. Typical reverse recovery current as a function of diode current slope
($V_R = 200V$, $T_j = 125^\circ C$,
Dynamic test circuit in Figure E)

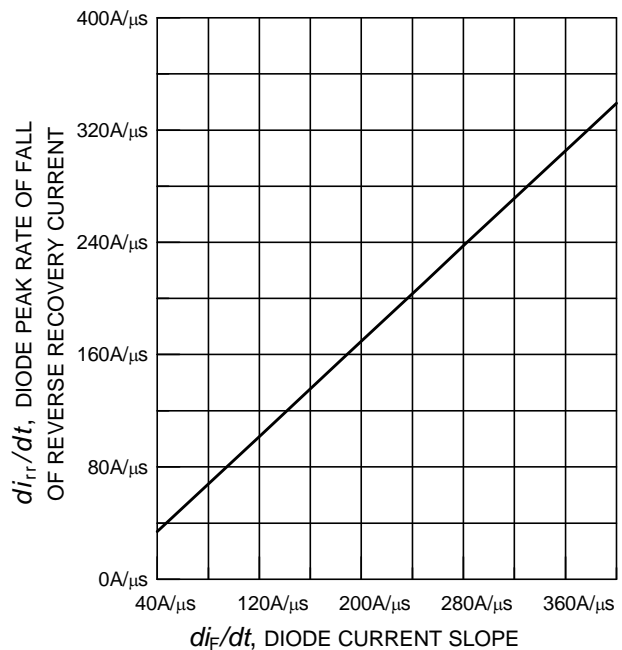

Figure 24. Typical diode peak rate of fall of reverse recovery current as a function of diode current slope
($V_R = 200V$, $T_j = 125^\circ C$,
Dynamic test circuit in Figure E)



SKP04N60

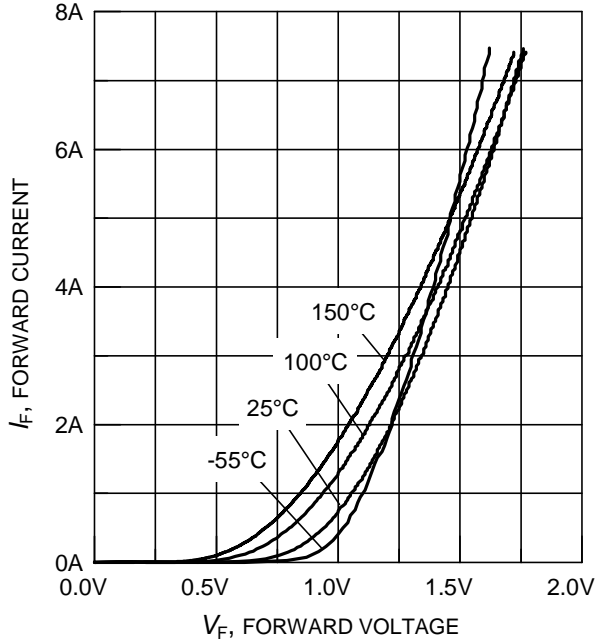

Figure 25. Typical diode forward current as a function of forward voltage

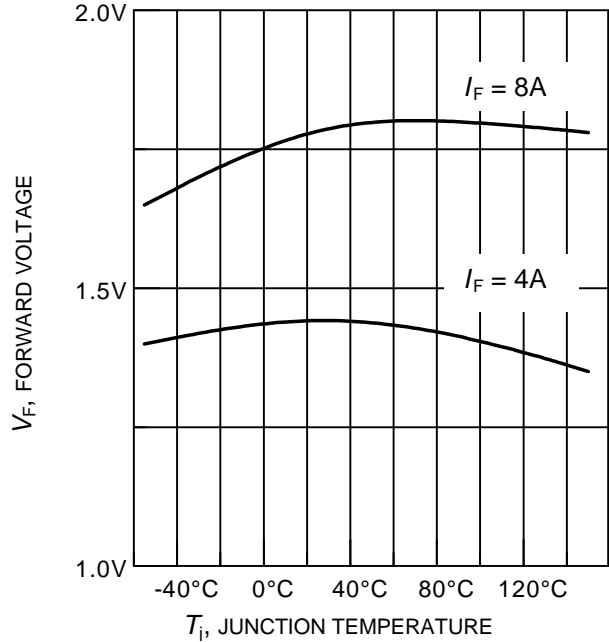

Figure 26. Typical diode forward voltage as a function of junction temperature

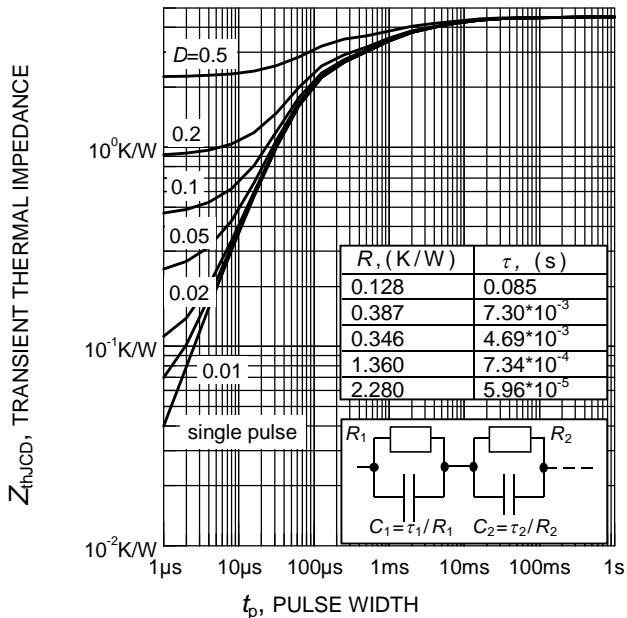
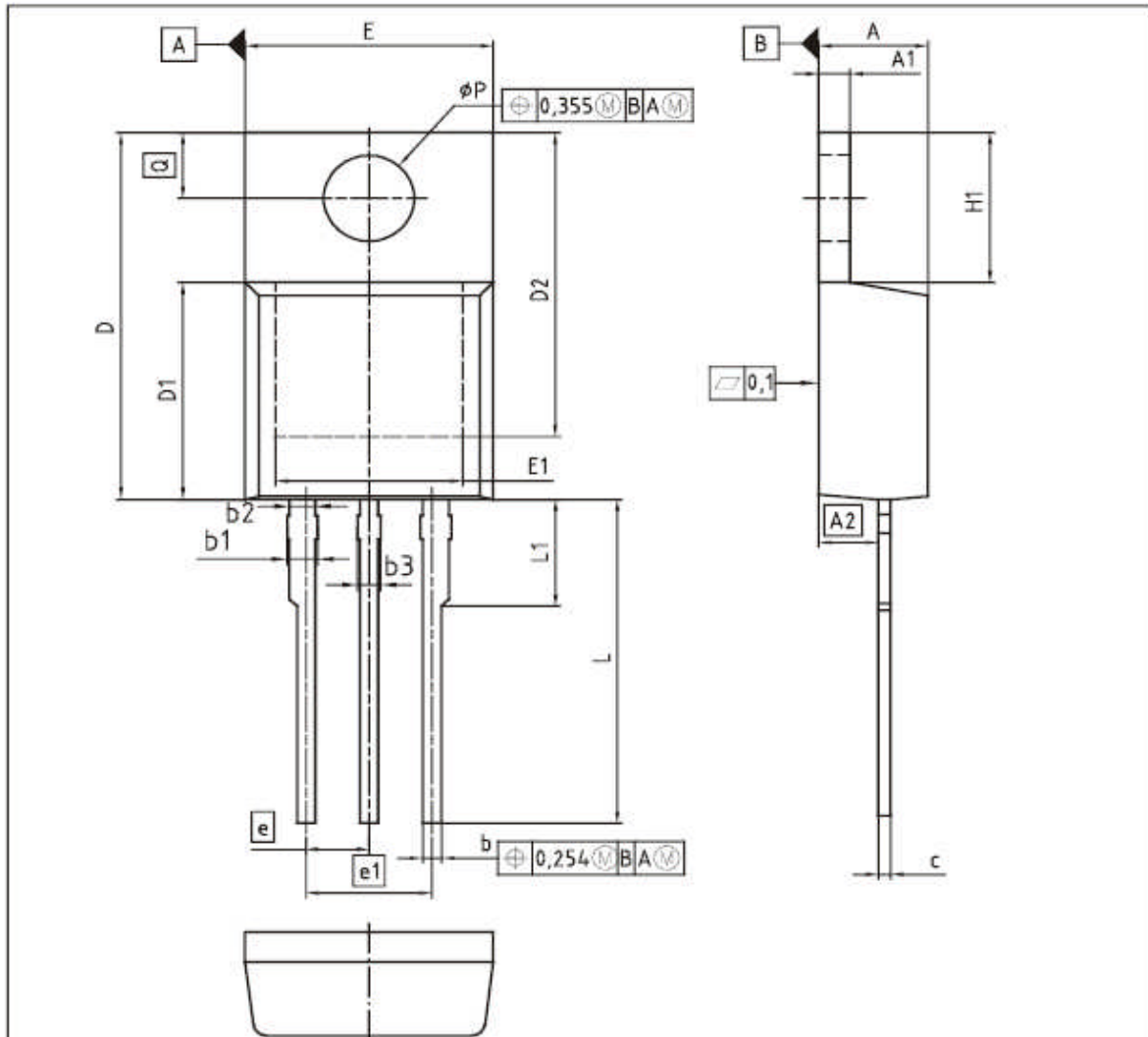

Figure 27. Diode transient thermal impedance as a function of pulse width ($D = t_p / T$)



SKP04N60

PG-TO220-3



DIM	MILLIMETERS		INCHES	
	MIN	MAX	MIN	MAX
A	4,30	4,57	0,169	0,180
A1	1,17	1,40	0,048	0,055
A2	2,15	2,72	0,085	0,107
b	0,65	0,86	0,026	0,034
b1	0,95	1,40	0,037	0,055
b2	0,95	1,15	0,037	0,045
b3	0,65	1,15	0,026	0,045
c	0,33	0,60	0,013	0,024
D	14,81	15,95	0,583	0,628
D1	8,51	9,45	0,335	0,372
D2	12,19	13,10	0,480	0,516
E	9,70	10,36	0,382	0,406
E1	6,50	8,60	0,256	0,339
e	2,54		0,100	
e1	5,08		0,200	
N	3		3	
H1	5,90	6,90	0,232	0,272
L	13,00	14,00	0,512	0,551
L1	-	4,80	-	0,189
eP	3,60	3,89	0,142	0,153
Q	2,60	3,00	0,102	0,118

DOCUMENT NO.
29800003318

SCALE

EUROPEAN PROJECTION

ISSUE DATE
30-07-2009

REVISION
06



SKP04N60

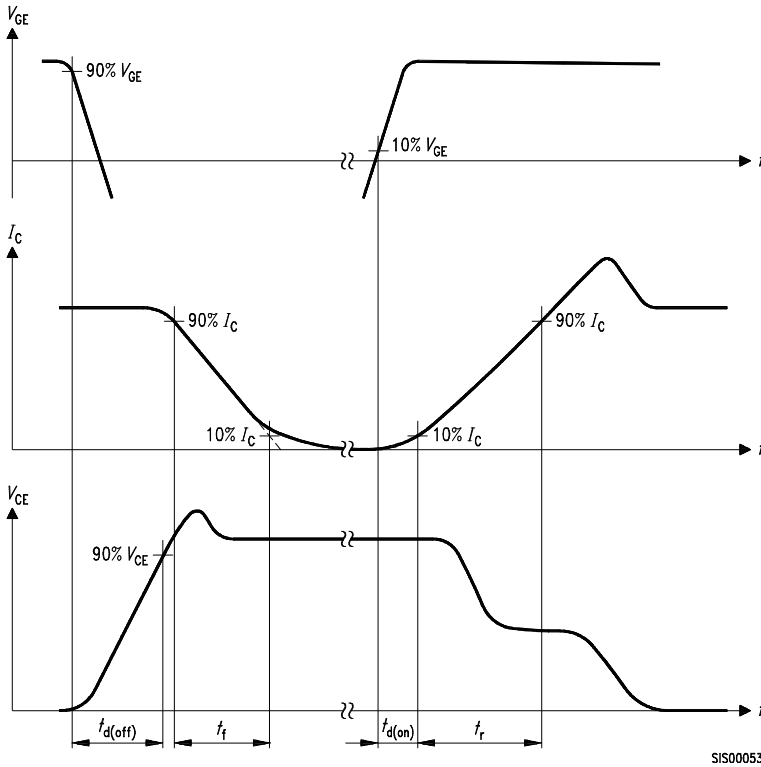

Figure A. Definition of switching times

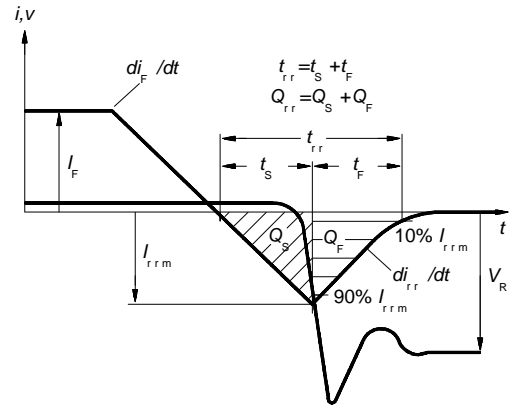

Figure C. Definition of diodes switching characteristics

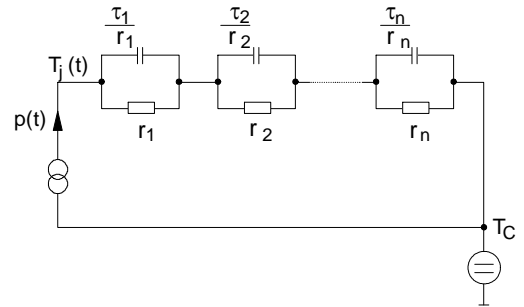

Figure D. Thermal equivalent circuit

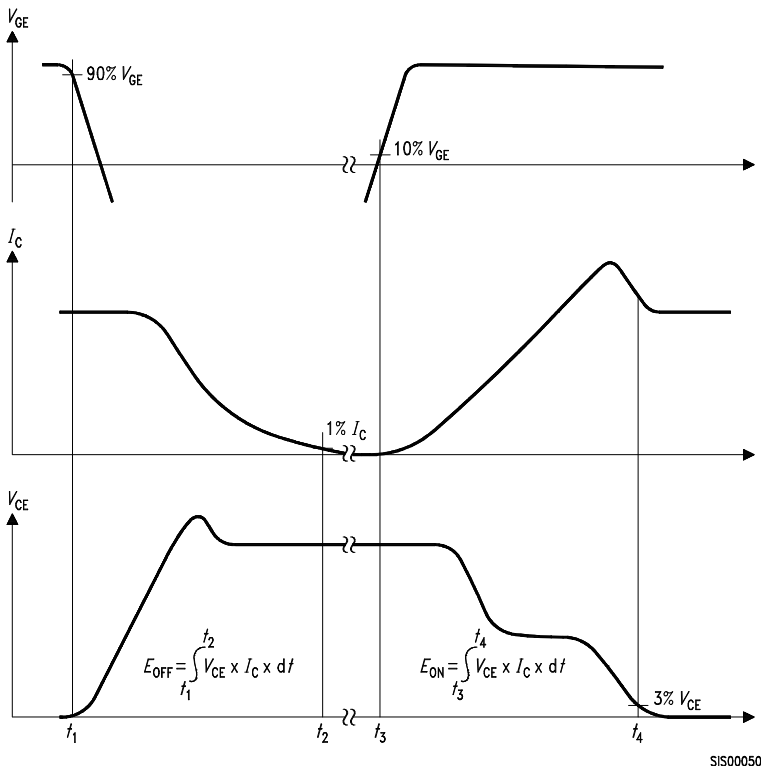

Figure B. Definition of switching losses

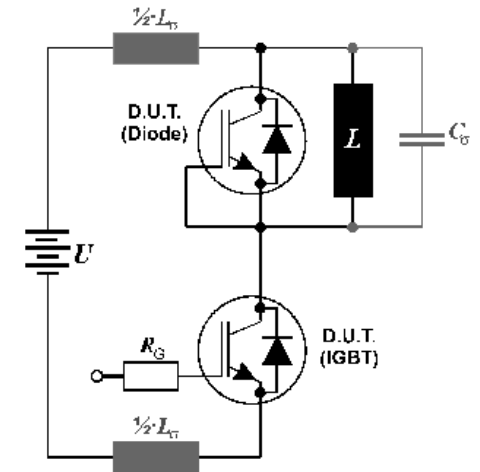

Figure E. Dynamic test circuit
Leakage inductance $L_{\sigma} = 180\text{nH}$
and Stray capacity $C_{\sigma} = 180\text{pF}$.



SKP04N60

Published by
Infineon Technologies AG
81726 Munich, Germany
© 2013 Infineon Technologies AG
All Rights Reserved.

Legal Disclaimer

The information given in this document shall in no event be regarded as a guarantee of conditions or characteristics. With respect to any examples or hints given herein, any typical values stated herein and/or any information regarding the application of the device, Infineon Technologies hereby disclaims any and all warranties and liabilities of any kind, including without limitation, warranties of non-infringement of intellectual property rights of any third party.

Information

For further information on technology, delivery terms and conditions and prices, please contact the nearest Infineon Technologies Office (www.infineon.com).

Warnings

Due to technical requirements, components may contain dangerous substances. For information on the types in question, please contact the nearest Infineon Technologies Office.

The Infineon Technologies component described in this Data Sheet may be used in life-support devices or systems and/or automotive, aviation and aerospace applications or systems only with the express written approval of Infineon Technologies, if a failure of such components can reasonably be expected to cause the failure of that life-support, automotive, aviation and aerospace device or system or to affect the safety or effectiveness of that device or system. Life support devices or systems are intended to be implanted in the human body or to support and/or maintain and sustain and/or protect human life. If they fail, it is reasonable to assume that the health of the user or other persons may be endangered.