

Excellent Integrated System Limited

Stocking Distributor

Click to view price, real time Inventory, Delivery & Lifecycle Information:

[Artesyn Embedded Technologies](#)
[SIL80C2-00SADJ-VJ](#)

For any questions, you can email us directly:

sales@integrated-circuit.com

POWER

SIL/SMT80C2 Series

C-Class Non-Isolated; 80 Amps

Data Sheet

Total Power: 400 Watts
Input Voltage: 4.7 - 13.8 Vdc
of Outputs: Single

SPECIAL FEATURES

- 80 A current rating
- Input voltage range: 4.7 - 13.8 Vdc
- Output voltage range: 0.8375 - 5.1 V
- Current sharing
- Industry-leading value
- Cost optimized design
- Excellent transient response
- Output voltage adjustability
- Path for future upgrades
- Supports silicon voltage migration
- Reduced design-in and qual time
- RoHS compliant

SAFETY

- Designed to meet UL, cUL 60960-1 (EN60950)

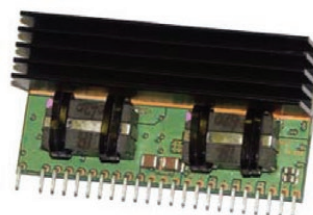

Electrical Specifications

Input		
Input voltage range		4.7 - 13.8 Vdc
Input current	Minimum load Remote OFF	290 mA 30 mA
Input current (max.)	See Note 3	60 A @ I _o max.
Start-up time	Power up Remote ON/OFF	<12 ms <12 ms
Output		
Output voltage	See Note 5	0.8375 - 5.1 V
Output setpoint accuracy	1.0% trim resistors	±1.0%
Line regulation	Low line to high line	±0.2% max.
Load regulation	Full load to min. load	±0.5% max.
Min./max. load		0 A/80 A
Overshoot	At turn-on	0.5% max.
Undershoot	At turn-off	100 mV max.
Ripple and noise 5 Hz to 20 MHz	See Note 1	35 mV V _{in} = 12 V, V _{out} = 2.5 V
Transient response (See Note 1, 2)	Deviation: V _{in} - 12 V V _{out} = 2.5 V	20 μs recovery to within regulation band
General		
Efficiency	V _o = 2.5 V, V _{in} = 12 V, I _{out} = 80 A	93% typical
Switching frequency	Fixed	500 kHz
Material flammability		UL94V-0
Weight		1.6 oz.
MTBF	12 V @ 40 °C, 100% load Bellcore 332	3.7 Mhrs
Coplanarity		TBD

SIL/SMT80C2 Series Data Sheet

Environmental Specifications

Thermal performance	Operating ambient temperature	-0 °C to +70 °C
See Note 6	Non-operating ambient temperature	-40 °C to +125 °C
Protection		
Overtemperature protection	Hiccup, non-latching	
Short-circuit	Hiccup, non-latching	
Recommended System Capacitance		
Input	See Note 7	0 μF
Output	See Note 8	0 μF

Ordering Information

Model Number ^(3,9)	Input Voltage	Output Voltage	Output Current (Min.)	Output Current (Max.)	Efficiency (Typical)	Regulation	
						Line	Load
SIL80C2-00SADJ-HJ	4.7 - 13.8 Vdc	0.84 - 5 V	0 A	80 A	93%	±0.2%	±0.5%
SIL80C2-00SADJ-VJ	4.7 - 13.8 Vdc	0.84 - 5 V	0 A	80 A	93%	±0.2%	±0.5%
SMT80C2-00SADJJ	4.7 - 13.8 Vdc	0.84 - 5 V	0 A	80 A	93%	±0.2%	±0.5%

Part Number System with Options

Product Family	Rated Output Current	Performance	Generation	Input Voltage	Output Voltage	Mounting Option	Custom Options	RoHS Compliance [®]
SIL	80	C	2	0	SADJ	X	X	J
SIL = Single In Line	80 = 80 Amp	C = Cost Optimized	2 = Increased current density	00 = 4.7-13.8 V	Single Adjustable Output	V = Vertical H = Horizontal	Blank = 3.05 mm pin 3 = 3.50 mm pin (horizontal mount only)	J = Pb free (RoHS 6/6 compliant)
Product Family	Rated Output Current	Performance	Generation	Input Voltage	Output Voltage	Mounting Option	Custom Options	RoHS Compliance [®]
SMT	80	C	2	0	SADJ	X	X	J
SMT = Surface Mount	80 = 80 Amp	C = Cost Optimized	2 = Increased current density	00 = 4.7-13.8 V	Single Adjustable Output	V = Vertical Blank = Horizontal	Blank = Standard	J = Pb free (RoHS 6/6 compliant)

Setting Output Voltage

Default output voltage: 0.8375V

The output voltage may be adjusted with a resistor placed between Trim (Pin 1) and (-)Trim (Pin 5).

The formula for calculating the value of this resistor is:

$$R_{Trim} (k) = 1.675 / (V_{out} - 0.8375)$$

Notes:

1. Measured as per recommended system capacitance.
2. di/dt = 10 A/ μs, Vin = Nom, Tc = 25 °C, load change = 0.50 Io max. and vice versa.
3. External fusing is recommended.
4. Measured with external filter.
5. Uses external resistor from trim pin to (-) trim pin.
6. Airflow dependent, 300 LFM minimum required.
7. No capacitor needed for ripple current capability.
8. No capacitor needed for stability.
9. NOTICE: Some models do not support all options. Please contact your local Artesyn Embedded Technologies representative or use the on-line model number search tool at <http://www.artesyn.com/power> to find a suitable alternative.

SIL/SMT80C2 Series Data Sheet

Mechanical Drawings

SIL80C2-00SADJ-VJ

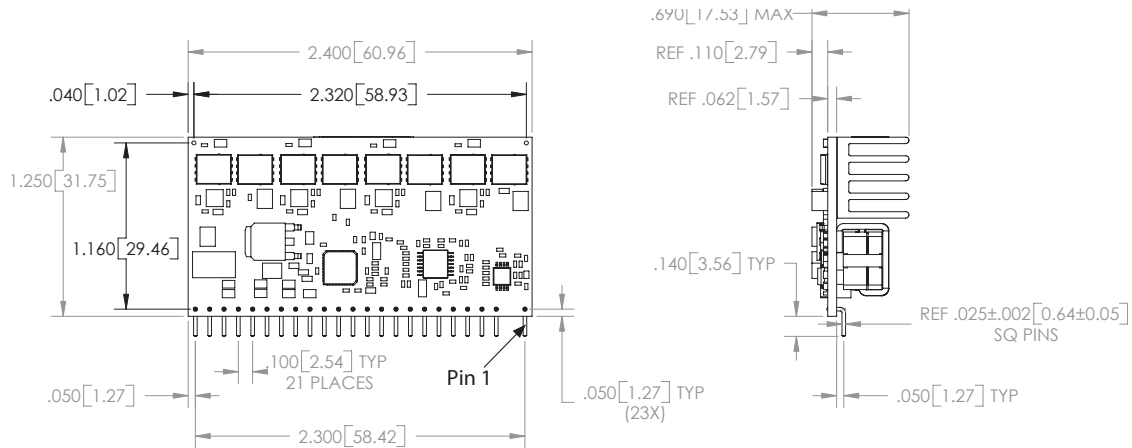

Footprint

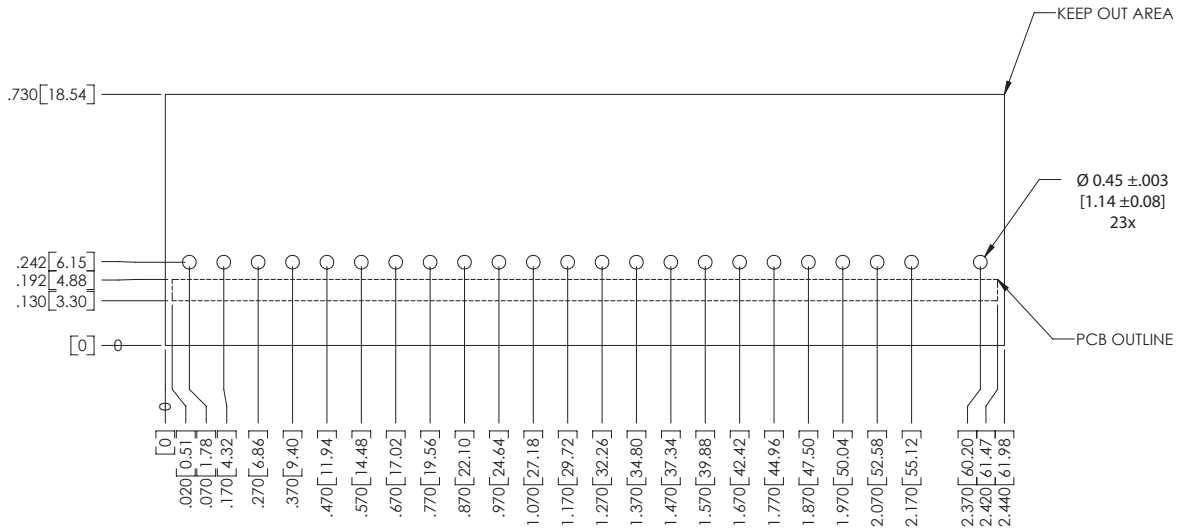

Pin Assignments			
Pin	Function	Pin	Function
1	Trim	14	Vin
2	No Pin	15	Vout
3	Ground	16	Vout
4	Power Good	17	Ground
5	(-) Trim	18	Vout
6	Ishare	19	Ground
7	Ground	20	Vout
8	Ground	21	Ground
9	Enable	22	Vout
10	Rem Sense (-)	23	Ground
11	Rem Sense (+)	24	Vout
12	Vin	25	Mech Pin (Horz mount only)
13	Vin	26	Mech Pin (Horz mount only)

SIL/SMT80C2 Series Data Sheet

Mechanical Drawings

SIL80C2-00SADJ-HJ/H3J

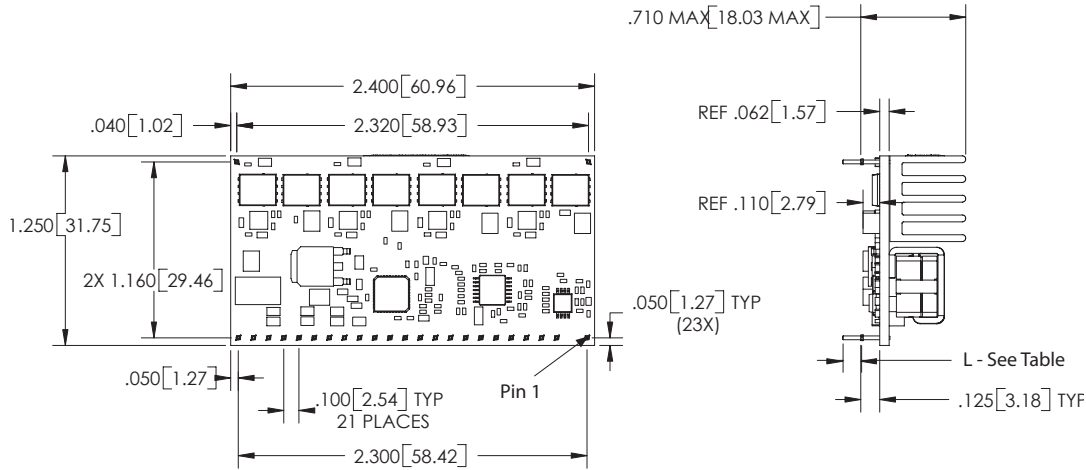

Model	L Dimension
SIL80C2-00SADJ-HJ	REF .120 [3.05]
SIL80C2-00SADJ-H3J	REF .138 [3.50]

Footprint

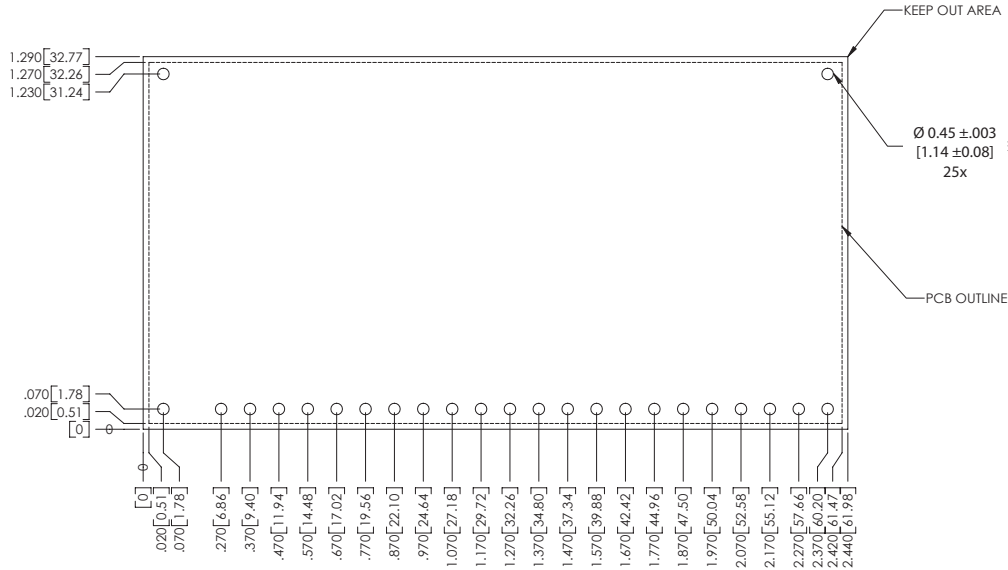

SIL/SMT80C2 Series Data Sheet

Mechanical Drawings

SMT80C2-00SADJ-VJ

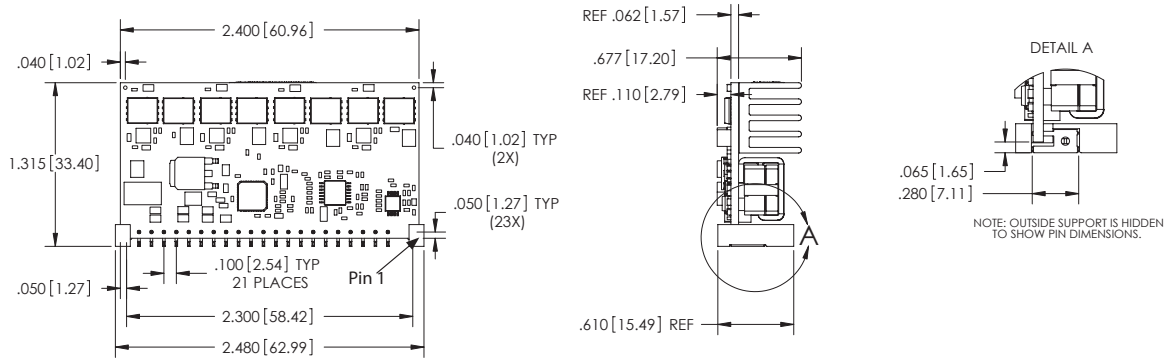

Footprint

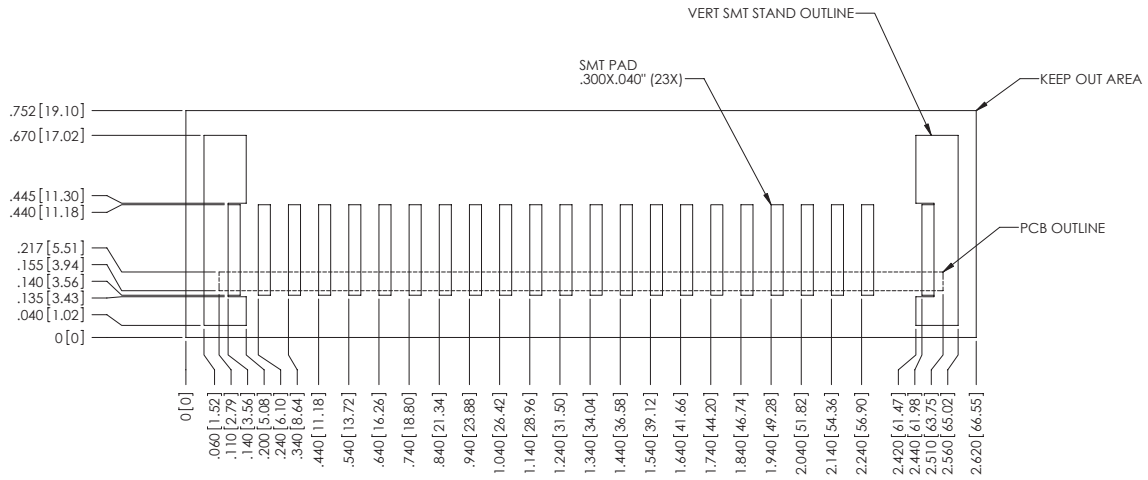

SIL/SMT80C2 Series Data Sheet

Mechanical Drawings

SMT80C2-00SADJ-VJ

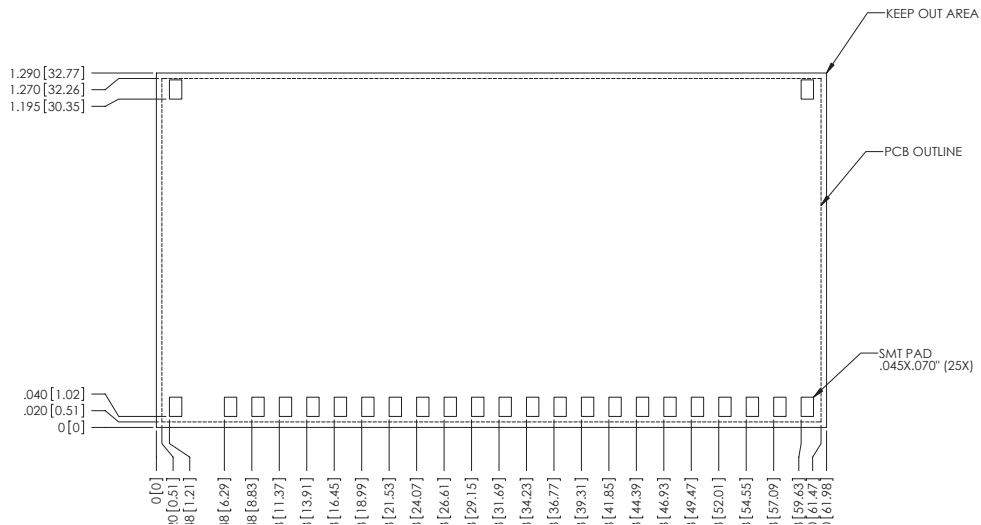
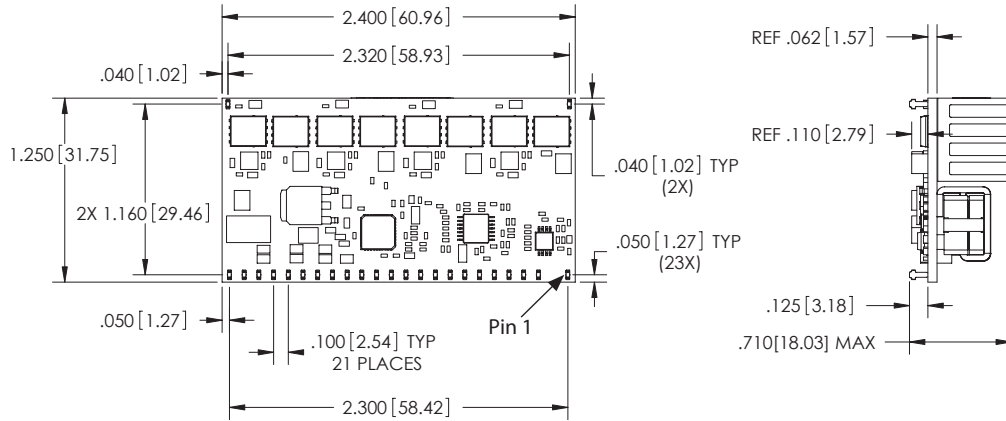

WORLDWIDE OFFICES

Americas

2900 S.Diablo Way
 Tempe, AZ 85282
 USA
 +1 888 412 7832

Europe (UK)

Waterfront Business Park
 Merry Hill, Dudley
 West Midlands, DY5 1LX
 United Kingdom
 +44 (0) 1384 842 211

Asia (HK)

14/F, Lu Plaza
 2 Wing Yip Street
 Kwun Tong, Kowloon
 Hong Kong
 +852 2176 3333



www.artesyn.com

Artesyn Embedded Technologies, Artesyn and the Artesyn Embedded Technologies logo are trademarks and service marks of Artesyn Embedded Technologies, Inc. All other names and logos referred to are trade names, trademarks, or registered trademarks of their respective owners. © 2015 Artesyn Embedded Technologies, Inc. All rights reserved. For full legal terms and conditions, please visit www.artesyn.com/legal.

For more information: www.artesyn.com/power
 For support: productsupport.ep@artesyn.com