

Excellent Integrated System Limited

Stocking Distributor

Click to view price, real time Inventory, Delivery & Lifecycle Information:

[Hammond Manufacturing](#)
[1437S16S](#)

For any questions, you can email us directly:

sales@integrated-circuit.com

Type 4, 4X Stainless Steel Pushbutton Enclosures *1437SS Series*

Extra Deep



Application

- Designed to accept standard heavy duty oil tight pushbuttons, switches and pilot lights.
- Provides protection from dirt, dust, oil and water.

Standards

- UL 508 Type 4 and 4X
- CSA Enclosure 4 and 4X
- **Complies with**
 - NEMA Type 4 and 4X
 - IEC 60529, IP66
 - JIC STD EGP-1-1967
- Appropriate components are required to maintain these standards.

Construction

- Formed from 14 gauge steel except A which is 16 gauge.
- Smooth continuously welded seams.
- Welded brackets provide for enclosure mounting.
- Captive cover screws fasten into threaded, sealed wells.
- Larger enclosures provide internally hinged removable covers, designed to hold the cover open during wiring (see table).
- Oil resistant gasket and adhesive.
- A bonding stud is provided on the door and a grounding stud is provided on the enclosure.

Finish

- Natural stainless steel with a smooth brushed finish.

Accessories

- Hole Plugs
- Ground Wire Kits
- Pedestal and Base

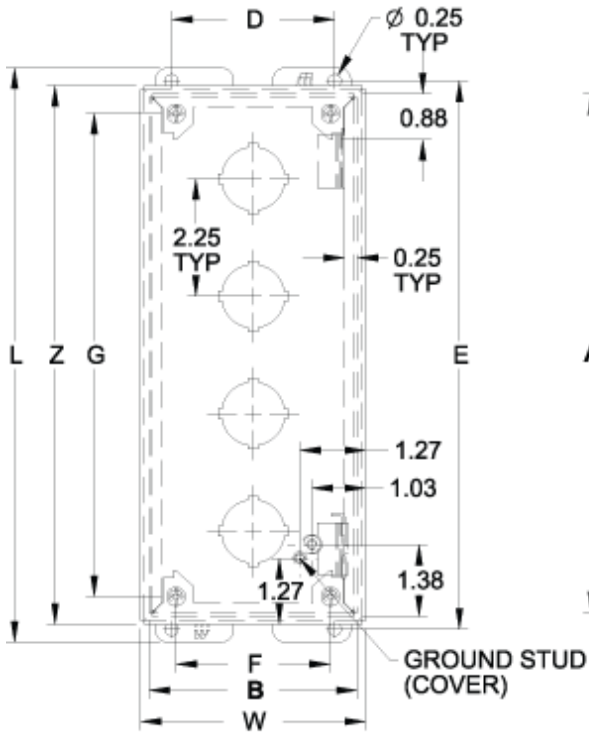

Front View
Body Type B through S
(Hinged)

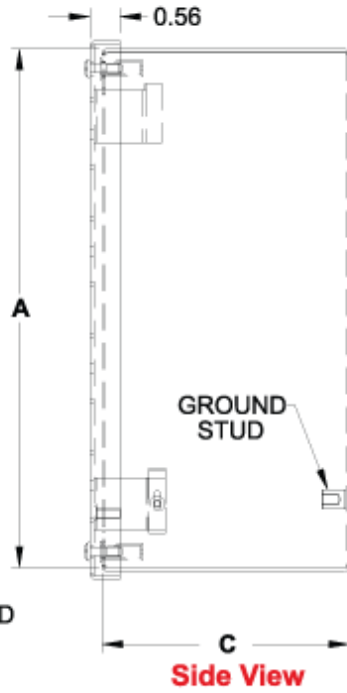

Side View

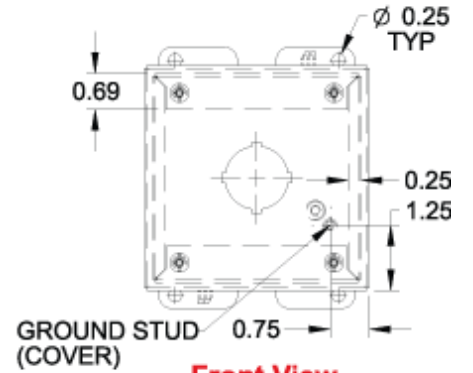

Front View
Body Type A
(Not Hinged)

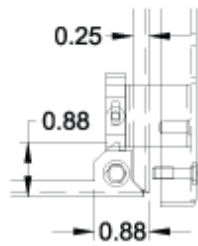

Hinge Detail

Retractable pin allows door to be mounted on left or right side

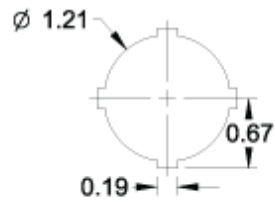

22.5mm Detail
(1437M Series)

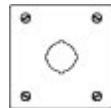

1



2

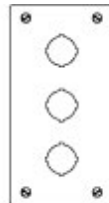

3

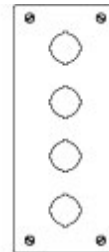

4

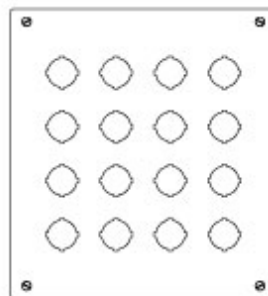

16



Distributor of Hammond Manufacturing: Excellent Integrated System Limited

Datasheet of 1437S16S - BOX S STEEL NAT 11.75"LX10.75"W

Contact us: sales@integrated-circuit.com Website: www.integrated-circuit.com

Part No.				No. Of	Overall Dimensions									Ship Wt. lbs.	
304 SS 22.5mm	304 SS 30.5mm	316 SS 22.5mm	316 SS 30.5mm		Holes	A	B	C	D	E	F	G	L		W
1437MSSA¹	1437SSA¹	1437MS16A¹	1437S16A¹	1	4.00	4.00	4.75	3.13	4.50	2.96	3.25	5.00	4.31	4.31	3
1437MSSB	1437SSB	1437MS16B	1437S16B	2	6.00	4.00	4.75	3.13	6.50	2.96	5.25	7.00	4.31	6.31	4
1437MSSC	1437SSC	1437MS16C	1437S16C	3	8.00	4.00	4.75	3.13	8.50	2.96	7.25	9.00	4.31	8.31	5
1437MSSD	1437SSD	1437MS16D	1437S16D	4	10.00	4.00	4.75	3.13	10.50	2.96	9.25	11.00	4.31	10.31	5
-	1437SSS	-	1437S16S	16	11.75	10.75	4.75	9.88	12.25	9.71	11.00	12.75	11.06	12.06	10

¹ Not hinged

Data subject to change without notice