



Distributor of IXYS Corporation: Excellent Integrated System Limited
Datasheet of LDS8726 - IC LED Driver DC DC Regulator PWM Dimming 1.9A (Switch)
Backlight 8-TDFN (2x3)

Contact us: sales@integrated-circuit.com Website: www.integrated-circuit.com

Excellent Integrated System Limited

Stocking Distributor

Click to view price, real time Inventory, Delivery & Lifecycle Information:

[IXYS Corporation](#)
[LDS8726](#)

For any questions, you can email us directly:

sales@integrated-circuit.com

LDS8726



49 WLED Driver with Boost Converter

FEATURES

- High efficiency boost converter with the input voltage range from 2.7 to 5.5 V
- No external Schottky Required (Internal synchronous rectifier*)
- 250 mV current sense voltage
- Drives up to 7 LEDs per string with up to 49 LED in 7 strings at 25 mA
- 1 MHz Switching Frequency
- Efficiency greater than 83%
- PWM LED Dimming Control Mode
- Over-voltage, under-voltage, over-current, and over-temperature protection
- Low Shutdown Current (<1µA)
- Available in 2 x 3 x 0.8 mm 8-pin TDFN package

APPLICATION

- Color Display Backlight
- Portable Navigation and GPS Receivers
- Smart phones
- Digital Photo Frames
- Portable DVD Players, Notebooks

DESCRIPTION

The LDS8726 is a fixed frequency current mode boost converter with internal synchronous rectifier and cycle-by-cycle switch current limit specifically designed to drive matrix of LEDs in respect with the Table 1. Operation at 1 MHz allows use of small value low profile inductor (10 – 33 µH) and 1 µF 50 V ceramic capacitor.

The use of integrated synchronous rectifier makes the efficiency dependent on only inductor DC

TYPICAL APPLICATION CIRCUIT

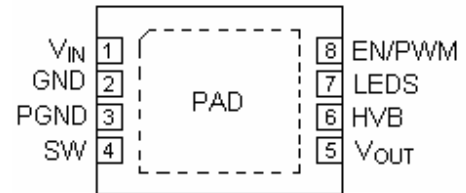
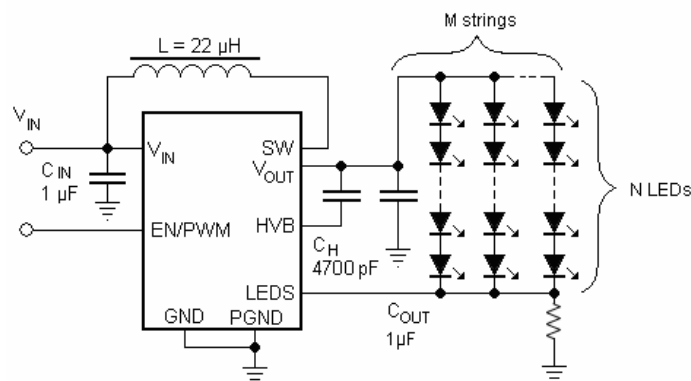

resistance. Under-voltage protection disables the part when V_{IN} voltage reaches 2.0 V

The LDS8726 has thermal shutdown set at 150 °C. Above this value, the boost converter stops switching. The part resumes normal operations when temperature drops below 130 °C.

The over-current protection provides cycle-by-cycle current limit.

The internal output over-voltage protection prevents damage in the case of a faulty LED disconnect.

The PWM control ensures brightness adjustment with a frequency from 100 Hz up to 30 KHz.

The EN/PWM logic input functions as a chip enable and LED current PWM control pin.

The device is available in 8-pin TDFN 2 x 3 mm package with a max height of 0.8 mm.

Table 1 Matrix configuration for LDS8726

Number of strings	Number of LED per string	String Current max, mA,	$V_{IN MIN}$, V
1 - 5	7	30	2.7
6	7	30	3.3
6	7	25	2.7
7	7	25	3.1
7	6	25	2.7
8	5	25	2.7

*) Patent pending

LDS8726



ABSOLUTE MAXIMUM RATINGS

Parameter	Rating	Unit
V_{IN} voltage	6	V
V_{OUT} , SW, LEDS, V_{HVB} voltage	40	V
EN/SET voltage	$V_{IN} + 0.7V$	V
Storage Temperature Range	-65 to +160	°C
Junction Temperature Range	-40 to +125	°C
8-pin TDFN package Thermal Resistance	65	°C/W
Soldering Temperature	300	°C

RECOMMENDED OPERATING CONDITIONS

Parameter	Rating	Unit
V_{IN}	2.7 to 5.5	V
Ambient Temperature Range	-40 to +85	°C

Typical application circuit with external components is shown on page 1.

ELECTRICAL OPERATING CHARACTERISTICS

(Over recommended operating conditions unless specified otherwise) $V_{IN} = 3.6V$, $T_{AMB} = 25^{\circ}C$, $C_{IN} = 1 \mu F$, $C_{OUT} = 1 \mu F$, $L = 22 \mu H$

Name	Conditions	Min	Typ	Max	Units
Quiescent Current	$V_{IN} = 3.6 V$, V_{OUT} open		1		mA
	$V_{IN} = 3.6 V$, $I_{LED} = 25 mA$ @ $V_{OUT} = 36 V$		3		
Shutdown Current	$V_{IN} = 5.5V$, EN = 0V			1	μA
LED Current Accuracy	At factory preset value		± 3		%
Oscillator Frequency			1.0		MHz
Maximum Duty Cycle			92		%
NMOSFET Switch On Resistance			0.3		Ω
PMOSFET Switch On Resistance			1.5		Ω
Switch Leakage Current				0.1	μA
Switch Current Limit			1.9		A
Dropout/Current sense voltage	At factory preset value		250		mV
PWM Frequency		0.1		30	kHz
EN/PWM Pin	Input Resistance (pull down)		250		k Ω
	Logic Level	High	1.4		V
		Low			
Thermal Shutdown			150		°C
Thermal Hysteresis			20		
Over-Voltage Protection			26		V
Soft Start Time			1.5		ms
Delay Time to Shutdown	EN = 0		10		ms

LDS8726



TYPICAL CHARACTERISTICS

$V_{in} = 3.6V$, $I_{OUT} = 30mA$ (1 string with 7 LEDs, $C_{IN} = 1 \mu F$, $C_{OUT} = 1 \mu F$, $L = 22 \mu H$, $T_{AMB} = 25^{\circ}C$ unless otherwise specified)

Power Efficiency vs. Input Voltage

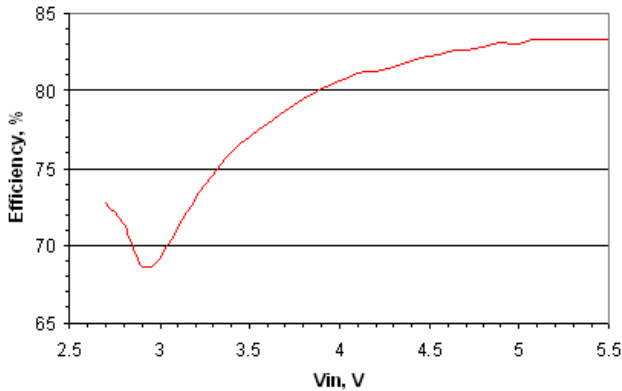

LED Current vs. Input Voltage

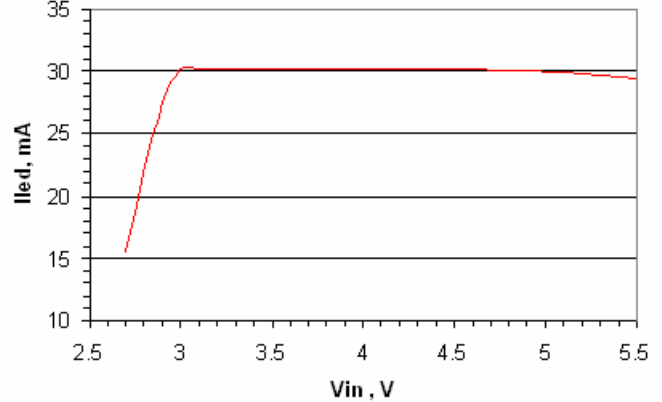

LED Current vs. PWM Duty Cycle

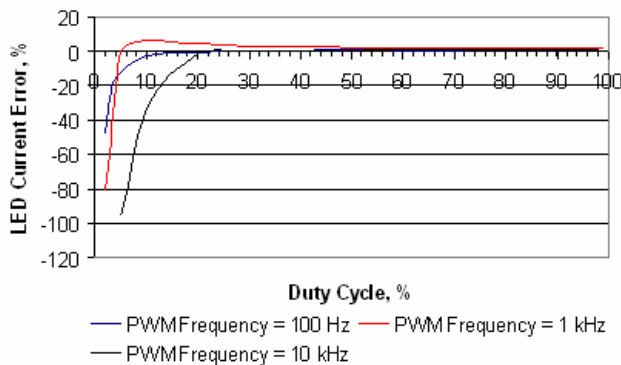

LED Current Error vs. PWM Frequency

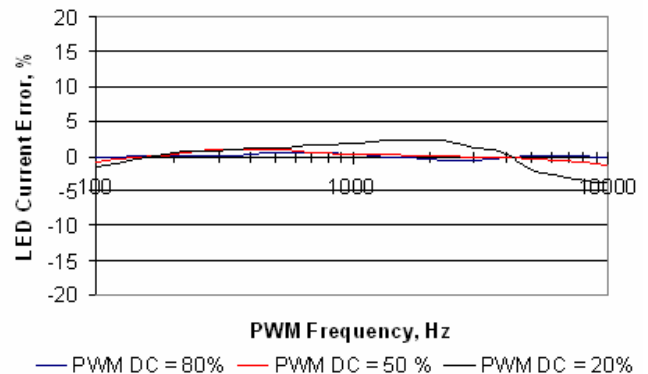

Soft Start Waveforms

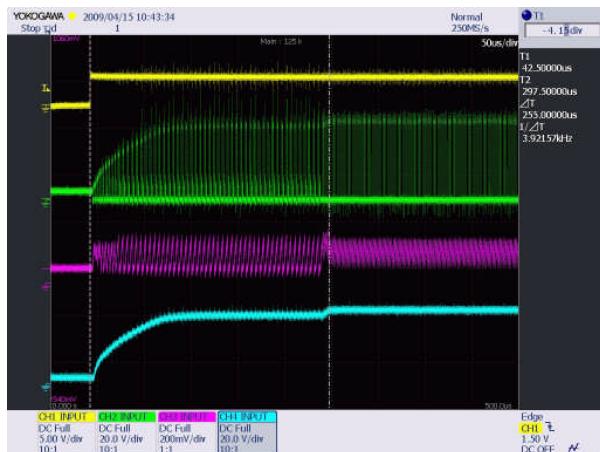

Ch 1 (yellow) – EN pin, Ch 2 (green) – SW node voltage
Ch 3 (red) – Inductor current, Ch 4 (blue) – V_{OUT}

Operating Waveforms

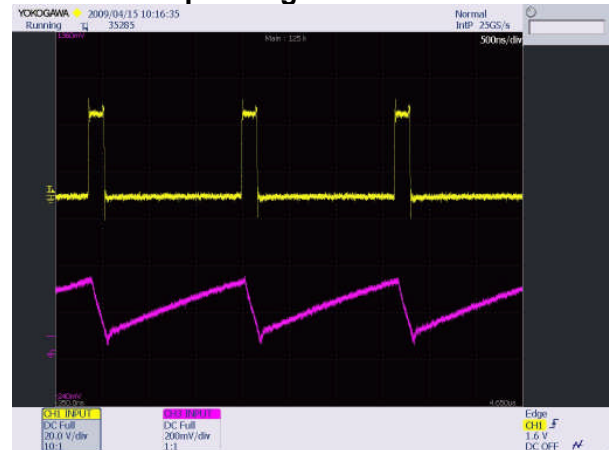

Ch 1 (yellow) - SW node voltage,
Ch 3 (red) – Inductor current

LDS8726



TYPICAL CHARACTERISTICS

$V_{in} = 3.6V$, $I_{OUT} = 30mA$ (1 string with 7 LEDs, $C_{IN} = 1\mu F$, $C_{OUT} = 1\mu F$, $L = 22\mu H$, $T_{AMB} = 25^{\circ}C$ unless otherwise specified)

Waveforms at PWM LED Current Regulation

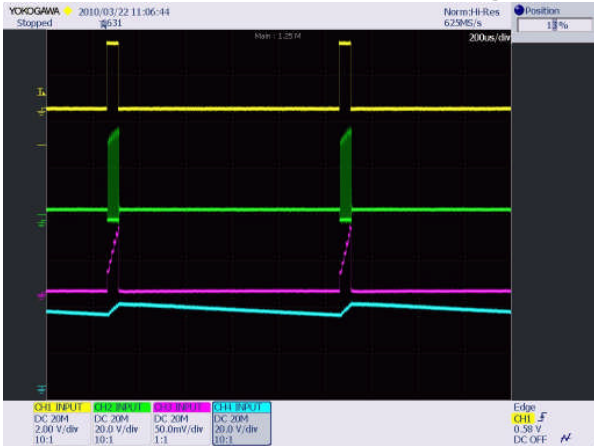

Ch 1 (yellow) – PWM signal at 1 kHz 5% duty cycle
 C2 (green) – SW node voltage, Ch 3(red) – LED Current.
 Ch4 (blue) - V_{OUT}

Waveforms at PWM LED Current Regulation



Ch 1 (yellow) – PWM signal at 1 kHz 98% duty cycle
 C2 (green) – SW node voltage, Ch 3(red) – LED Current.
 Ch4 (blue) - V_{OUT}

Waveforms at PWM LED Current Regulation



Ch 1 (yellow) – PWM signal at 30 kHz 25% duty cycle
 C2 (green) – SW node voltage, Ch 3(red) – LED Current.
 Ch4 (blue) - V_{OUT}

Waveforms at PWM LED Current Regulation

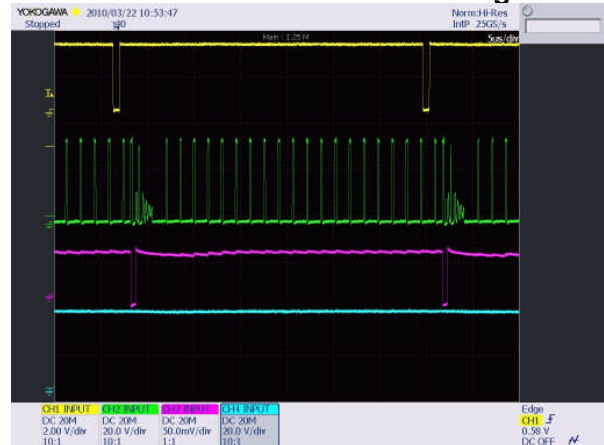

Ch 1 (yellow) – PWM signal at 30 kHz 98% duty cycle
 C2 (green) – SW node voltage, Ch 3(red) – LED Current.
 Ch4 (blue) - V_{OUT}

LDS8726



PIN DESCRIPTION

Pin #	Name	Function
1	V _{IN}	Input Voltage, connect to battery or power supply
2	GND	Analog Ground
3	PGND	Power Ground
4	SW	Switch input; Connect inductor terminal to this pin
5	V _{OUT}	Output voltage; Connect the LED string anode terminal to this pin.
6	HVB	High Voltage Bypass; Connect a 470 pF capacitor between this point and V _{OUT}
7	LEDS	Current Sense input. Connect LED string cathode terminal to this pin
8	EN/PWM	Device Enable (active high) and Dimming Control
PAD	PAD	Connect to GND on the PCB

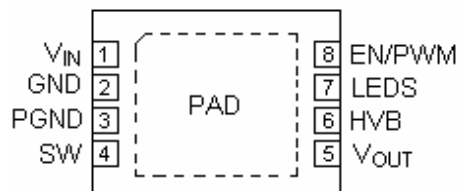

Top view: TDFN 8-lead 2 X 3 mm

PIN FUNCTION

V_{IN} is the supply pin for the driver. A small 1 μ F ceramic bypass capacitor is required between the V_{IN} pin and ground near the device. The operating input voltage range is from 2.7 V to 5.5 V. If the input supply voltage falls below the under-voltage threshold, switch is disabled, and the device enters shutdown mode.

HVB is the internal high voltage reference point. Connect a 4700 pF capacitor between this point and V_{OUT}.

EN/PWM is the enable and PWM control logic input. Guaranteed levels of logic high and logic low are set at 1.4 V and 0.4 V respectively. When EN/PWM is initially taken high, the device becomes enabled and LED current sets to maximum programmed value.. To place the device into shutdown mode, the EN/PWM pin must be held low for more than 10 ms.

V_{OUT} is the driver output. Connect it to the LED anode. A ceramic bypass capacitor of 1 μ F requires between the V_{OUT} pin and ground near the device.

GND is the ground reference for the analog circuits. The pin must be connected to the ground plane on the PCB. Avoid high currents flowing trough traces connecting this pin with EN/PWM signal source.

PGND is the current return for high current circuits. The pin must be connected to the ground plane on the PCB. Connect GND and PGND as close to the driver as possible.

LEDS is the Current Sense pin that provides internal regulated current sink for LED string. Connect LED string cathode to this pin. This pin enter high-impedance zero current state whenever the device is in shutdown mode.

PAD is the exposed pad underneath the package. For best thermal performance, the pad should be soldered to the PCB and connected to the ground plane

LDS8726



If the input supply voltage falls below the under-voltage threshold, switch is disabled, and the device enters shutdown mode.

LED Selection

The number of the LEDs in string is limited by maximum output voltage that cannot exceed over-voltage protection level. We recommend using not more than 10 LEDs with $V_F \leq 3.6$ V in string if V_{IN} voltage is above 3.0 V and not more than 8 LEDs if V_{IN} may fall up to 2.7 V.

External Components Selection

The LDS8726 requires four external components only. The recommended input capacitor value is between 1.0 and 10uF, while the output capacitor selection is function of desired output ripple, loop stability, and inrush current. We recommend $C_{OUT} = 1 \mu F$.

The inductor should allow around 20% higher peak current than LDS8726 Switch Current Limit I_{LIM} (see table *Electrical Operating Characteristics* on page 2).

However, the maximum ripple current through inductor I_R should not exceed

$$I_R = 2 \left(I_{LIM} - \frac{I_{LED} (NV_F + V_d)}{V_{IN} \eta} \right), \text{ where}$$

V_F - is a LED forward voltage, V
 N - is number of LEDs per string
 V_d - is a current regulator voltage drop = 0.2 V,
 V_{IN} - is an input voltage, V

We recommend continuous conduction mode for inductor to achieve highest efficiency. That limits I_R value as

$$I_R < \frac{2I_{LED} (NV_F + V_d)}{\eta V_{IN}}$$

Inductor value L is a function of switching frequency, input and output voltage and is determined by following equation:

$$L = \frac{1}{I_R f \left(\frac{1}{NV_F + V_d + V_{PM}} - \frac{1}{V_{IN}} \right)}, \text{ where}$$

V_{PM} - is a voltage drop across synchronous rectifier (PMOSFET) = 1.5 ohms x I_{LED} , (A),

L - is an inductance, H, and
 f - is a switching frequency, 700 kHz.

Inductor should have minimum DC resistance to avoid driver's efficiency degradation.

The equation for the output capacitor selection is:

$$C_{OUT} = \frac{(NV_F + V_d - V_{IN}) I_{OUT}}{(NV_F + V_d) V_R f}, \text{ where}$$

V_R - is a ripple voltage at the output.

For example:

If $V_{IN} = 2.7$ V, $N = 7$, $V_F = 3.3$ V, $V_d = 0.25$ V, $f = 1$ MHz, $I_{OUT} = 90$ mA, (3 strings in parallel x 30 mA) and ripple voltage $V_R = 0.1$ V, $C_{OUT} = 0.63 \mu F$ so 1 μF is a good choice.

We recommend $C_{OUT} = 1 \mu F$ to achieve better efficiency and driver's stability.

Recommended Layout

In active mode, the driver switches internally at a high frequency. We recommend minimize trace length to all external capacitors and inductor. The input and output ceramic capacitors (X5R or X7R type) should located as close to the device' pins as possible to prevent from EMI distribution

A ground plane should cover the area under the driver IC as well as the bypass capacitors. Short connection to ground on capacitors C_{IN} and C_{OUT} can be implemented with the use of multiple via. A copper area matching the TDFN exposed pad (PAD) must be connected to the ground plane underneath. The use of multiple via improves the package heat dissipation.

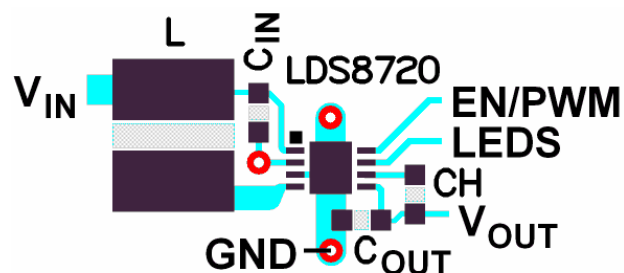

Figure 3. Recommended layout

LDS8726



PACKAGE DRAWING AND DIMENSIONS

8-PIN TDFN, 2mm x 3mm, 0.5mm PITCH

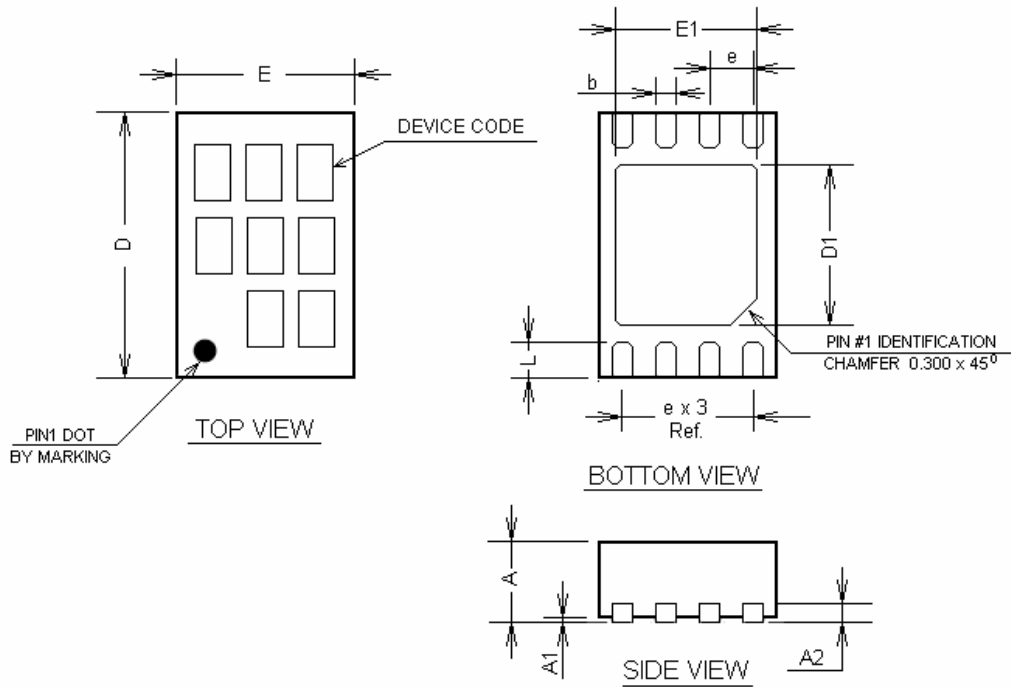

SYMBOL	MIN	NOM	MAX
A	0.700	0.750	0.800
A1	-	0.000	0.050
A2		0.203 Ref.	
b	0.180	0.230	0.280
D	2.950	3.000	3.050
D1	1.750	1.800	1.850
E	1.950	2.000	2.050
E1	1.550	1.600	1.650
e		0.500 Bsc	
L	0.350	0.400	0.450

Note:

1. All dimensions are in millimeters
2. Complies with JEDEC Standard MO-220

LDS8726



ORDERING INFORMATION

Part Number	Package	Package Marking
LDS8726 008-T2 ¹⁾ – 200 ²⁾	TDFN - 8 2 x 3mm ³⁾	720

Notes:

- Quantity per reel is 2000
- Maximum LED current is factory preset at 20 mA. Consult factory if other current values are required.
- Matte-Tin Plated Finish (RoHS-compliant)

EXAMPLE OF ORDERING INFORMATION

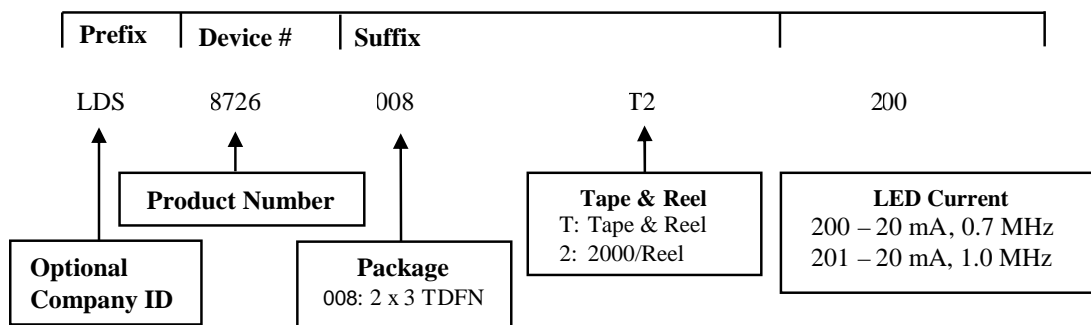

Notes:

- All packages are RoHS-compliant (Lead-free, Halogen-free).
- The standard lead finish is Matte-Tin.
- The device used in the above example is a LDS8726 XXX–T2-200 (2x3 TDFN, Tape & Reel, 20 mA LED Current, 0.7 MHz switching frequency).
- For additional package and current options, please contact your nearest IXYS Corp. Sales office.

LDS8726



Warranty and Use

IXYS CORP. MAKES NO WARRANTY, REPRESENTATION OR GUARANTEE, EXPRESS OR IMPLIED, REGARDING THE SUITABILITY OF ITS PRODUCTS FOR ANY PARTICULAR PURPOSE, NOR THAT THE USE OF ITS PRODUCTS WILL NOT INFRINGE ITS INTELLECTUAL PROPERTY RIGHTS OR THE RIGHTS OF THIRD PARTIES WITH RESPECT TO ANY PARTICULAR USE OR APPLICATION AND SPECIFICALLY DISCLAIMS ANY AND ALL LIABILITY ARISING OUT OF ANY SUCH USE OR APPLICATION, INCLUDING BUT NOT LIMITED TO, CONSEQUENTIAL OR INCIDENTAL DAMAGES.

IXYS Corp. products are not designed, intended, or authorized for use as components in systems intended for surgical implant into the body, or other applications intended to support or sustain life, or for any other application in which the failure of the IXYS Corp. product could create a situation where personal injury or death may occur.

IXYS Corp. reserves the right to make changes to or discontinue any product or service described herein without notice. Products with data sheets labeled "Advance Information" or "Preliminary" and other products described herein may not be in production or offered for sale.

IXYS Corp. advises customers to obtain the current version of the relevant product information before placing orders. Circuit diagrams illustrate typical semiconductor applications and may not be complete.



IXYS Corp.
1590 Buckeye Dr.,
Milpitas, CA 95035-7418
Phone: 408.457.9000
Fax: 408.496.0222
<http://www.ixys.com>

Document No: 8726DS
Revision: N1.0
Issue date: 2/8/2011