

Excellent Integrated System Limited

Stocking Distributor

Click to view price, real time Inventory, Delivery & Lifecycle Information:

[Bel Fuse Inc.](#)
[133-3701-316](#)

For any questions, you can email us directly:
sales@integrated-circuit.com

MCX 50 Ohm Right Angle PC Mount Jack Receptacle

INCHES (MILLIMETERS)
CUSTOMER DRAWINGS AVAILABLE UPON REQUEST

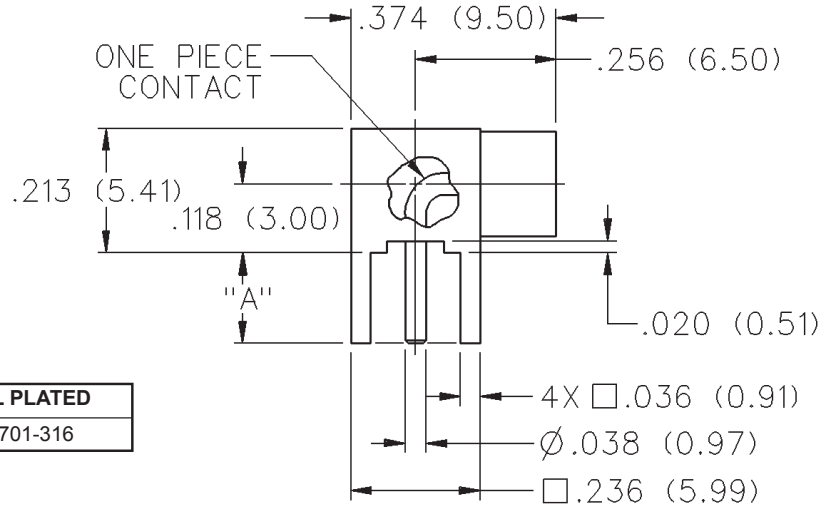

"A"	GOLD PLATED	NICKEL PLATED
.110 (2.79)	133-3701-311	133-3701-316

