

## Excellent Integrated System Limited

Stocking Distributor

Click to view price, real time Inventory, Delivery & Lifecycle Information:

[Kingbright](#)  
[AA3528SESK](#)

For any questions, you can email us directly:  
[sales@integrated-circuit.com](mailto:sales@integrated-circuit.com)

# Kingbright

## 3.5x2.8mm SURFACE MOUNT LED LAMP

Part Number: AA3528SESK

Super Bright Orange

### Features

- Single color.
- Suitable for all SMT assembly and solder process.
- Available on tape and reel.
- Ideal for backlighting.
- Package : 2000pcs / reel.
- Moisture sensitivity level : level 3.
- RoHS compliant.

### Description

The Super Bright Orange device is made with AlGaInP (on GaAs substrate) light emitting diode chip.

### Package Dimensions

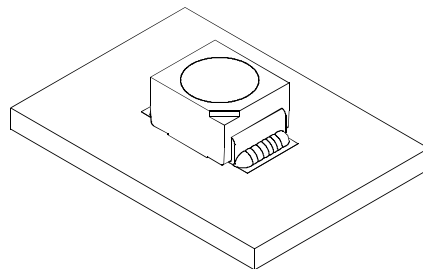
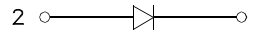
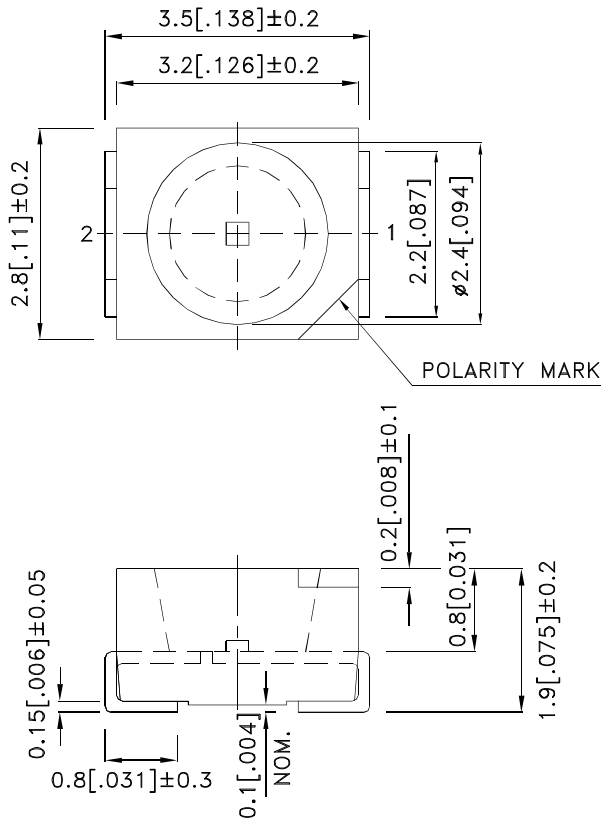

#### Notes:

1. All dimensions are in millimeters (inches).
2. Tolerance is ±0.25(0.01") unless otherwise noted.
3. The specifications, characteristics and technical data described in the datasheet are subject to change without prior notice.
4. The device has a single mounting surface. The device must be mounted according to the specifications.



# Kingbright

## Handling Precautions

Compare to epoxy encapsulant that is hard and brittle, silicone is softer and flexible. Although its characteristic significantly reduces thermal stress, it is more susceptible to damage by external mechanical force.

As a result, special handling precautions need to be observed during assembly using silicone encapsulated LED products. Failure to comply might lead to damage and premature failure of the LED.

1. Handle the component along the side surfaces by using forceps or appropriate tools.

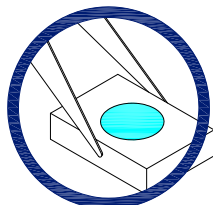

2. Do not directly touch or handle the silicone lens surface. It may damage the internal circuitry.

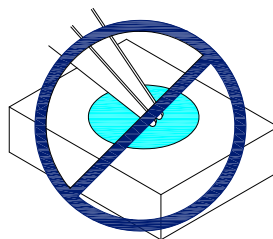
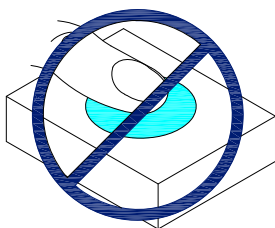

3. Do not stack together assembled PCBs containing exposed LEDs. Impact may scratch the silicone lens or damage the internal circuitry.

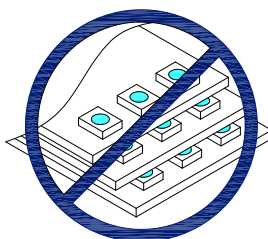

- 4.1. The inner diameter of the SMD pickup nozzle should not exceed the size of the LED to prevent air leaks.
- 4.2. A pliable material is suggested for the nozzle tip to avoid scratching or damaging the LED surface during pickup.
- 4.3. The dimensions of the component must be accurately programmed in the pick-and-place machine to insure precise pickup and avoid damage during production.

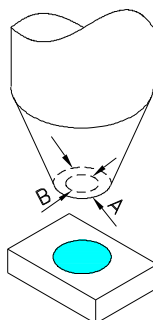

5. As silicone encapsulation is permeable to gases, some corrosive substances such as H<sub>2</sub>S might corrode silver plating of leadframe. Special care should be taken if an LED with silicone encapsulation is to be used near such substances.

All design applications should refer to Kingbright application notes available at <http://www.KingbrightUSA.com/ApplicationNotes>

# Kingbright

## Selection Guide

| Part No.   | Dice                          | Lens Type   | Iv (mcd) [2]<br>@ 20mA |      | Viewing<br>Angle [1] |
|------------|-------------------------------|-------------|------------------------|------|----------------------|
|            |                               |             | Min.                   | Typ. | 2θ1/2                |
| AA3528SESK | Super Bright Orange (AlGaInP) | Water Clear | 200                    | 350  | 120°                 |
|            |                               |             | *120                   | *230 |                      |

Notes:

- θ1/2 is the angle from optical centerline where the luminous intensity is 1/2 of the optical peak value.
- Luminous intensity/ luminous Flux: +/-15%.
- \*Luminous intensity value is traceable to the CIE127-2007 compliant national standards.

## Electrical / Optical Characteristics at TA=25°C

| Symbol | Parameter                | Device              | Typ. | Max. | Units | Test Conditions |
|--------|--------------------------|---------------------|------|------|-------|-----------------|
| λpeak  | Peak Wavelength          | Super Bright Orange | 610  |      | nm    | IF=20mA         |
| λD [1] | Dominant Wavelength      | Super Bright Orange | 601  |      | nm    | IF=20mA         |
| Δλ1/2  | Spectral Line Half-width | Super Bright Orange | 29   |      | nm    | IF=20mA         |
| C      | Capacitance              | Super Bright Orange | 15   |      | pF    | VF=0V;f=1MHz    |
| VF [2] | Forward Voltage          | Super Bright Orange | 2.1  | 2.5  | V     | IF=20mA         |
| IR     | Reverse Current          | Super Bright Orange |      | 10   | uA    | VR=5V           |

Notes:

- Wavelength: +/-1nm.
- Forward Voltage: +/-0.1V.
- Wavelength value is traceable to the CIE127-2007 compliant national standards.

## Absolute Maximum Ratings at TA=25°C

| Parameter                | Super Bright Orange | Units |
|--------------------------|---------------------|-------|
| Power dissipation        | 75                  | mW    |
| DC Forward Current       | 30                  | mA    |
| Peak Forward Current [1] | 195                 | mA    |
| Reverse Voltage          | 5                   | V     |
| Operating Temperature    | -40°C To +85°C      |       |
| Storage Temperature      | -40°C To +85°C      |       |

Note:

- 1/10 Duty Cycle, 0.1ms Pulse Width.

# Kingbright

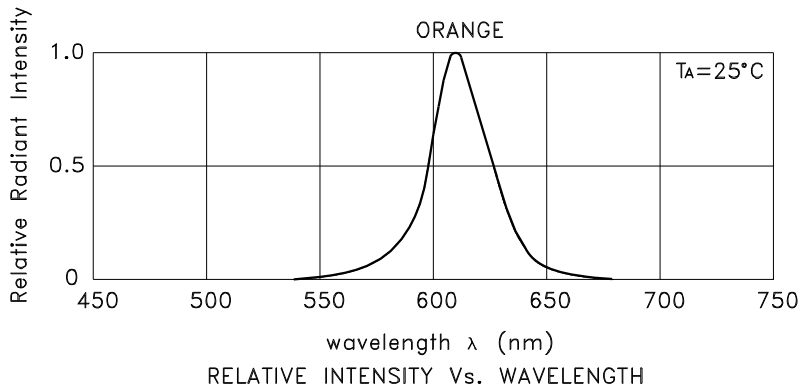

## Super Bright Orange AA3528SESK

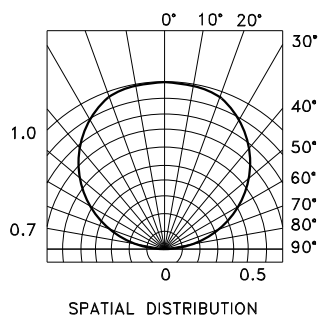
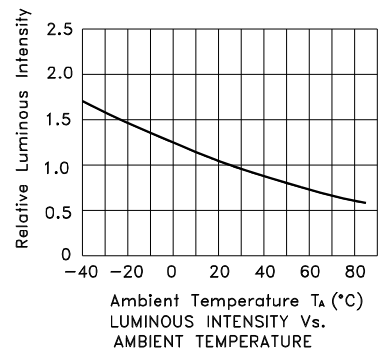
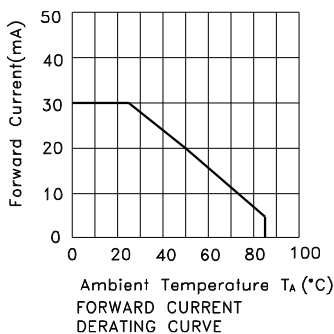
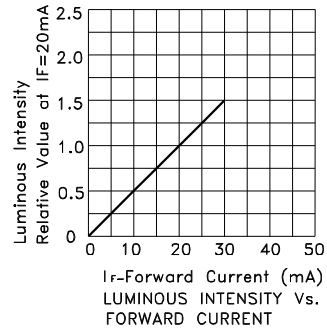
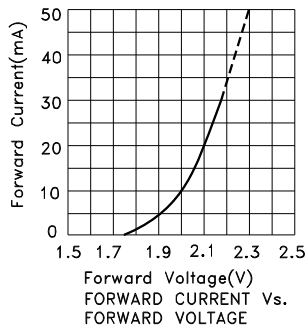

# Kingbright

## AA3528SESK

Reflow soldering is recommended and the soldering profile is shown below.  
 Other soldering methods are not recommended as they might cause damage to the product.

Reflow Soldering Profile For Lead-free SMT Process.

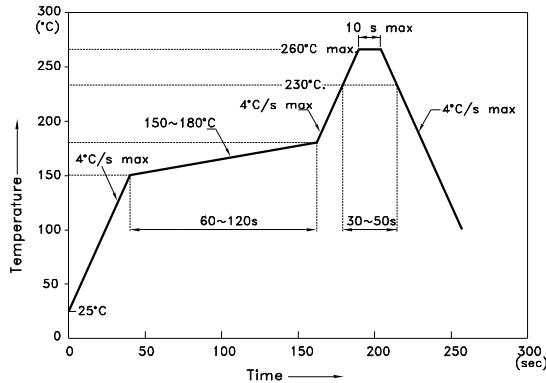

- NOTES:
1. We recommend the reflow temperature 245°C(+/-5°C). The maximum soldering temperature should be limited to 260°C.
  2. Don't cause stress to the epoxy resin while it is exposed to high temperature.
  3. Number of reflow process shall be 2 times or less.

### Recommended Soldering Pattern (Units : mm; Tolerance: ± 0.1)

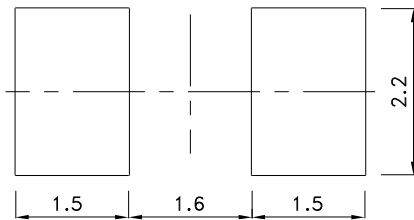

### Reel Dimension

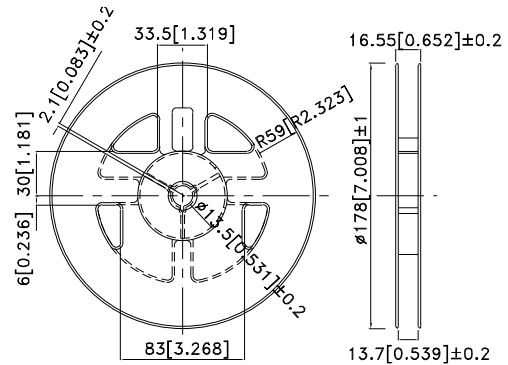

### Tape Dimensions (Units : mm)

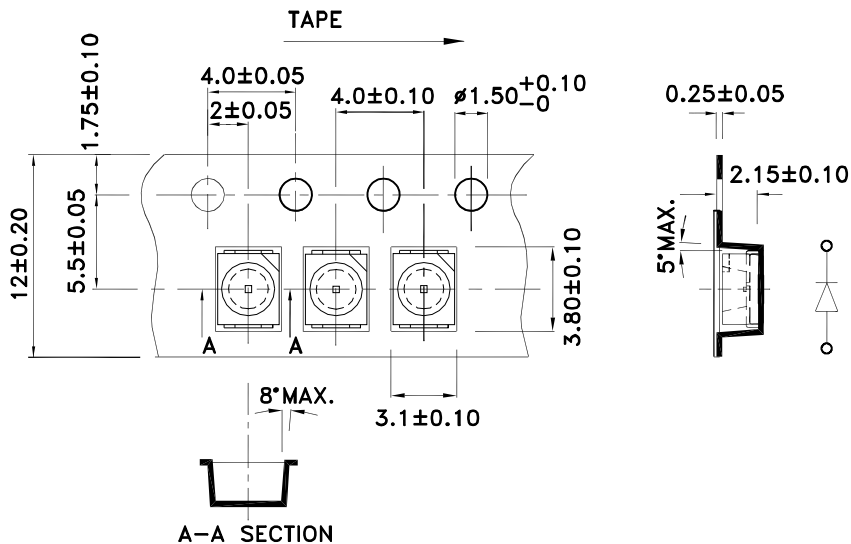

# Kingbright

**PACKING & LABEL SPECIFICATIONS**

**AA3528SESK**

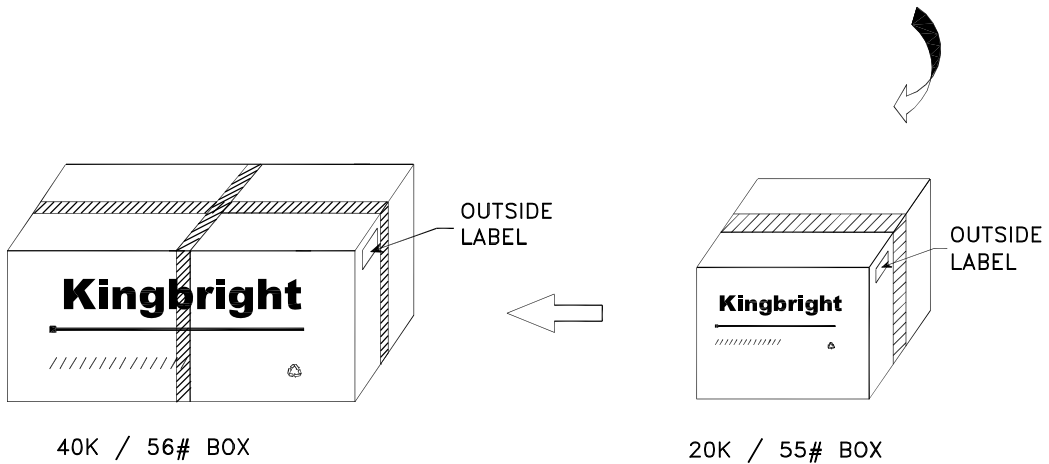
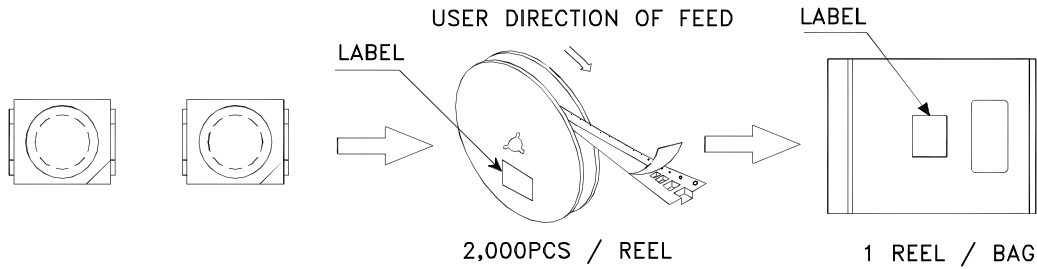

|   |  |
|---|--|
| <h2 style="margin: 0;">Kingbright</h2>  |  |
| P/NO: AA3528xxx   |  |
| QTY: 2,000 pcs  | Q.C. <span style="border: 1px solid black; border-radius: 50%; padding: 2px;">Q C<br/>xx xx xxxx<br/>PASSED</span> |
| S/N: XXXX   |  |
| CODE: XXX   |  |
| LOT NO:   |  |
| <br><small>xxxxxxxxxxxxxxxxxxxxxxxxxxxxxxxx</small> |  |
| RoHS Compliant  |  |