

Excellent Integrated System Limited

Stocking Distributor

Click to view price, real time Inventory, Delivery & Lifecycle Information:

[3M](#)
[FPC-KIT](#)

For any questions, you can email us directly:

sales@integrated-circuit.com

3M™ Heat Shrink Tubing and Devices Product Catalog



Trusted Technology,
Reliable Protection
and Insulation

Table of Contents

Selection Guide	2
Introduction	5
3M™ Single-Wall Polyolefin Tubing	7
FP-301 Tubing	8
Flexible polyolefin flame-retardant tubing.	
FP-301 Tubing Kits	9
Heat shrink tubing kits and refill packs.	
FP-301 VW Tubing.....	10
Flexible polyolefin UL VW-1 tubing.	
VFP-876 Tubing	11
Very flexible polyolefin tubing.	
SFTW-203 Tubing.....	12
Very flexible, 3:1, polyolefin tubing.	
3M Adhesive-Lined Tubing	13
MW Tubing	14
Semi-rigid, 2.5:1, adhesive-lined, polyolefin tubing.	
EPS-200 Tubing	15
Flexible, 2:1, adhesive-lined, polyolefin tubing.	
EPS-300 Tubing	16
Flexible, 3:1, adhesive-lined, polyolefin tubing.	
EPS-400 Tubing	17
Semi-rigid, 4:1, adhesive-lined, polyolefin tubing.	
TMW Tubing	18
Adhesive-lined, translucent, semi-rigid polyolefin.	
TES Heat Shrink Tubing	19
Adhesive-lined, 4:1, semi-rigid, clear polyolefin for the automotive industry.	
SMS Heat Shrink Tubing	20
Adhesive-lined, 4:1, semi-rigid, clear polyolefin for the automotive industry.	
3M Special Purpose Tubing	21
MFP Tubing	22
Semi-rigid, thin-wall, modified polyvinylidene fluoride tubing.	
NST Tubing.....	23
Flexible modified chlorinated polyolefin (Neoprene) tubing.	
VTN-200 Tubing	24
Flexible fluoroelastomer tubing.	
PSTH Tubing	25
Elastomeric polyester.	

Table of Contents (continued)

3M™ Heavy-Duty Tubing	26
MDT Tubing	27
Medium-duty polyolefin tubing.	
HDT Tubing.....	28
Heavy-duty polyolefin tubing.	
BBI-A Series	29
 3M™ Heat Shrinkable Molded Shapes	 31
Heavy Duty Breakout Boots HDBB-205 to 230.....	33
Heavy Duty Breakout Boots HDBB-310 to 345.....	34
Heavy Duty Breakout Boots HDBB-405 to 430.....	35
Heavy Duty Breakout Boot HDBB-505	36
Heavy Duty Breakout Boot HDBB-605	37
Heavy Duty End Caps SKE 4/10 to SKE 45/100	38
 3M Moisture Sealing Products	 39
Electrical Moisture Block	40
Electrical Moisture Sealant Pads	41
Mastic Pads.....	42
Adhesives.....	43
 3M Cold Shrink Connector Insulators	 44
8420 and 8440 Series.....	44

3M™ Heat Shrink Tubing Selection Guide

Product	Material/Typical Applications	Operating Temperature Range	Shrink Temp. (Min.)	Shrink Ratio	Standard Sizes Expanded Diameter	Dielectric Strength (V/mil)	Volume Resistivity (ohm-cm)	Tensile Strength (PSI)
Single-Wall Polyolefin Tubing								
FP-301	Flexible Polyolefin General purpose flame retardant insulation for UL, CSA and MIL-DTL-23053/5 applications; cable and component covering. Class 1 = opaque colors; Class 2 = clear.	-55°C to +135°C	212°F 100°C	2:1	3/64" to 4"	900	10 ¹⁵	2400
FP-301VW	Highly Flame-Retardant, Flexible Polyolefin Insulation applications, flame-retardant applications requiring UL VW-1 and CSA OFT, fire-resistant wiring.	-55°C to +135°C	212°F 100°C	2:1	3/64" to 4"	900	10 ¹⁵	2400
VFP-876	Very Flexible Polyolefin Terminal insulation, low shrink-temperature applications.	-55°C to +135°C	212°F 100°C	2:1	3/64" to 2"	800	10 ¹⁴	2100
SFTW-203	Very Flexible Polyolefin Shrink-fit jacketing and insulation of flexible wire bundles and temperature-sensitive components.	-55°C to +135°C	212°F 100°C	3:1	1/16" to 1 1/2"	700	10 ¹⁵	2600
Adhesive-Lined, Polyolefin Tubing								
MW	Multiple Wall Polyolefin Insulation, strain relief and sealing of electrical connections, wire splices and components.	-55°C to +110°C	275°F 135°C	2.5:1	1/8" to 1"	900	10 ¹⁵	2200
EPS-200	Environmental Protection Sleeve Insulation, strain relief and environmental protection of electrical wire bundles and components.	-55°C to +110°C	250°F 121°C	2:1	1/8" to 2"	800	10 ¹⁴	2100
EPS-300	Environmental Protection Sleeve Insulation, strain relief and environmental protection for automotive and marine wire bundles and splices.	-55°C to +110°C	250°F 121°C	3:1	1/8" to 1-1/2"	700	10 ¹⁴	2100
EPS-400	Environmental Protection Sleeve Insulation, strain relief and environmental protection for sealing voids in multiple wire bundles for automotive and marine applications.	-55°C to +110°C	250°F 121°C	4:1	.300" to .700"	700	10 ¹⁴	1900
TMW	Semi-Rigid Multiple Wall Terminal Protection Sleeve Insulation, strain relief and environmental protection. Uses include the manufacture of heat shrink butt connectors, ring terminals and fork terminals.	-55°C to +110°C	275°F 135°C		.183" to .330"	900	10 ¹⁴	2500
TES SMS	All-Weather, Heat-Shrinkable, Dual Wall, Polyolefin Tubing for Automotive Wire Harnesses.	-55°C to +110°C	250°F 121°C	4:1 4:1	.220" to .700"	500	10 ¹⁴	2450 1900
Special Purpose Tubing								
MFP	Polyvinylidene Fluoride Heat-resistant transparent insulation and marking for electronic and appliance applications.	-55°C to 175°C	347°F 175°C	2:1	3/64" to 1"	900	10 ¹⁴	5500
NST	Modified Neoprene Insulation and abrasion resistant covering of wiring and cable harnesses. Oil resistant coverings.	-70°C to +121°C	275°F 135°C	2:1	1/8" to 3"	800	10 ¹²	2100
VTN-200	Fluoroelastomer Synthetic fuel and hydraulic oil resistant applications, high-temperature coverings.	-55°C to +200°C	347°F 175°C	2:1	1/8" to 2"	500	10 ¹²	2400
PSTH	Flexible Elastomeric Polyester Designed for harsh operating conditions.	-55°C to +150°C	338°F 170°C	2:1	3/16" to 2"	500	10 ¹⁴	2200
Heavy-Duty Tubing								
MDT	Medium-Duty Excellent abrasion, corrosion and environmental protection. Flame retardant.	-55°C to +110°C	250°F 121°C	3:1	.400" to 4.30"	500	10 ¹⁴	2400
HDT	Heavy-Duty Fabricated from specially formulated cross-linked polyolefin, assuring long-term environmental protection. Highly chemical, abrasion and split resistant.	-55°C to +110°C	250°F 121°C	3:1	.300" to 7.00"	500	10 ¹⁴	2400
BBI	Bus Bar Tubing , Designed for insulating rectangular, square, or round bus bar rated 5 kV through 35 kV.	-55°C to +110°C	250°F 121°C		2.38" to 10.28"	550	10 ¹³	2200

Note: The materials are rated on a scale of 1–10 for flexibility:
1 = most flexible and 10 = most rigid.

*Material characteristics only.

Ultimate Elongation (%)	Longitudinal Change (± %)	Specific Gravity	Flammability	Corrosive Effect	Abrasion Resistance	Flexibility (see note below)	Fuel & Oil Resistance	Solvent Resistance	Resistance To Acids and Alkalis	Applicable Specifications
400	5	1.3	Self-Extinguish meets UL 224 All-Tubing Flame Test (except clear)	Non-Corrosive	Good	3	Good	Exc.	Exc.	SAE-AMS-DTL-23053/5*, Class 1, 2; UL File E-39100; CSA LR38227; ABS
400	+1, -10	1.5	Self-Extinguish meets UL 224 VW-1 Test	Non-Corrosive	Good	3	Good	Exc.	Exc.	SAE-AMS-DTL-23053/5*, Class 3; UL File E-39100, VW-1; CSA LR38227, OFT
450	5	1.3	Self-Extinguish meets UL 224 All-Tubing Flame Test	Non-Corrosive	Good	2	Good	Exc.	Exc.	SAE-AMS-DTL-23053/5*, Class 1; UL File E-39100; CSA LR38227
400	5	1.29	Self-Extinguish	Non-Corrosive	Good	3	Good	Good	Exc.	UL File E-48398; CSA LR38227 Meets functional requirements of SAE-AMS-DTL-28053/5, Class 1
400	+1, -10	1.0	Non-Flame Retardant	Non-Corrosive	Good	7	Good	Good	Exc.	SAE-AMS-DTL-23053/4*, Class 1; UL File E-157227; CSA LR38227
450	+1, -5	1.3	Self-Extinguish meets UL 224 All-Tubing Flame Test (jacket)	Non-Corrosive	Good	3	Good	Good	Exc.	SAE-AMS-DTL-23053/4*, Class 2; UL File E-39100; CSA LR38227
450	+1, -15	1.3	Self-Extinguish meets UL 224 All-Tubing Flame Test (jacket)	Non-Corrosive	Good	3	Good	Good	Exc.	UL File E-157227; ABS; CSA LR38227
400	+1, -10	1.25	Self-Extinguish	Non-Corrosive	Good	7	Good	Good	Exc.	UL File E-157227; CSA LR38227
400	+1, -10	1.0	Non-Flame Retardant	Non-Corrosive	Good	7	Good	Good	Exc.	UL File E-157227; CSA LR38227
450 350	+0, -10 +0, -10	0.97 1.25	TES Non-Flame Retardant SMS Self-Extinguish	Non-Corrosive Non-Corrosive	Good Good	TES 5 SMS 3	Good Good	Good Good	Exc. Exc.	ESB-M99D56-Ford MS-DB56-Chrysler
350	+1, -10	1.7	Self-Extinguish meets UL 224 VW-1 Test	Non-Corrosive	Exc.	10	Exc.	Exc.	Exc.	Meets performance claims of SAE-AMS-DTL-23053/18*, Class 1; SAE-AMS-DTL-23053/8*; UL File E-39100, VW-1, CSA LR38227 OFT
500	+1, -10	1.3	Self-Extinguish	Non-Corrosive	Exc.	1	Exc.	Good	Exc.	SAE-AMS-DTL-23053/1*, Class 1, 2; UL File E-39100; SC-X-15112
450	+1, -10	1.7	Self-Extinguish	Non-Corrosive	Exc.	4	Exc.	Exc.	Exc.	SAE-AMS-DTL-23053/13*
350	+2, -8	1.6	Self-Extinguish	Non-Corrosive	Exc.	4	Exc.	Exc.	Exc.	SC-X15111C; meets the functional requirements of SAE-AMS-DTL-23053/16*
475	+1, -10	1.28	Self-Extinguish	Non-Corrosive	Good	8	Good	Good	Exc.	SAE-AMS-DTL-23053/15*, Class 2; ABS
475	+1, -10	1.28	Self-Extinguish	Non-Corrosive	Good	9	Good	Good	Exc.	SAE-AMS-DTL-23053/15*, Class 1; ABS
575	+0, -10	1.20	Self-Extinguish	Non-Corrosive	Good	8	Good	Good	Exc.	ASTM-D-257, 149, 150, 2303; IEC 216; ANSI/IEEE Std C37.20

*Formerly MIL+23053 and MIL-DTL-23058 for sheet number noted after slash mark.

3M

Heat Shrink Products

3M™ Heat Shrink Products provide a uniquely effective means of applying skintight insulating and protective coverings for a wide variety of electrical, electronic and mechanical applications.

3M is committed to providing its customers with quality, service and quick delivery. Our people are professionally trained in the use of 3M's heat shrink products, so they can assist you with information and guide you to the right product for your specific needs.

Worldwide service

3M products, from tape to test equipment, are respected worldwide for their innovative features and reliable properties. 3M's service includes an excellent product at a fair price, application information, employee and field service training including instruction sheets and technical papers, easy access to 3M personnel through a toll-free number, and laboratory and technical service support from 3M operations worldwide. When you choose 3M, you choose more than a vendor, you choose a premier provider. You'll receive a quality product that will perform reliably and a company that is dedicated to responding to your

needs — now and in the future.

Meeting performance requirements

3M heat shrink products offer the important advantages of simple installation, improved performance and long-term reliability. They are abrasion resistant, withstand heat, corrosion, moisture and other hostile environments and offer excellent dielectric properties. Benefits can include cost, size and labor savings as well as enhanced product appearance.

Materials are specifically developed to meet demanding performance requirements and are manufactured under stringent quality-assurance standards. 3M heat shrink products meet or exceed the requirements of most military, commercial, aerospace and industrial OEM specifications. They have proven their effectiveness in the most demanding environments including outer space, undersea and underground.

In addition to the standard product line, 3M offers the capability to meet special requirements for custom-designed and manufactured heat shrink products. Research, development and testing laboratories exist in combination with complete facilities for production-scale

compounding, processing and cross-linking of polymeric materials. 3M also offers technical service and engineering support to assist you in evaluating your specific application needs.

Cross-linking

Products such as 3M Heat Shrink Tubing FP-301 are fabricated from specially modified polyolefin. Cross-linking converts the polyolefin, a meltable or thermoplastic material, into a non-melting, thermoset material and imparts a permanent "memory" to the polyolefin. This permits the material to be supplied in the expanded state and, with the application of heat, shrink to its original size.

In the process, the polyolefin is transformed into an entirely new class of high temperature material with significantly improved properties including increased temperature resistance, improved mechanical properties, solvent and chemical resistance, and thermal stability.

Cross-linking is used to enhance or alter one or more of the physical, chemical or electrical properties of a wide variety of polymers, such as polychloroprene, polyvinylidene fluoride, and other fluoropolymers. The combined application of cross-linking and polymer chemistry leads to the creation of specialized, high-performance heat shrink products offering characteristics that are outstanding when compared to the already proven properties of the polymeric base material.

Broad product range

3M offers a range of products based on heat shrink technology, including tubing, solder splice connectors and molded parts.

Product availability

All 3M heat shrink tubing and splicing products and pricing are available through your local 3M distributor.

To contact your local distributor or sales rep, refer to the 800 number listed on the back cover.



3M™ Single-Wall Polyolefin Tubing



- Meets UL/CSA specifications
- Meets military specifications
- Flame retardant
- Abrasion and tear resistant
- Chemical and solvent resistant
- 135°C (275°F) continuous operating temperature
- Easily marked
- Choice of colors and sizes





Heat Shrink Tubing FP-301

Flexible Polyolefin; Shrink Ratio 2:1

Product description

3M™ Heat Shrink Tubing FP-301 offers an outstanding balance of electrical, physical and chemical properties for a wide variety of industrial and military applications. Rated for 135°C (275°F) continuous operation, all FP-301 tubing is split resistant, mechanically tough, easily marked and resists cold flow.

FP-301 tubing meets AMS-DTL-23053/5* Class 1 & 2 requirements. It is UL Recognized and CSA Certified at 600 volts at 125°C (257°F) (UL File No. E-39100; CSA No. 38227).

FP-301 tubing is rated for continuous operation from -55°C (-67°F) to 135°C (275°F) and withstands elevated temperatures to 300°C (572°F) for short periods. Minimum shrink temperature for all FP-301 tubing is 100°C (212°F).

Typical applications

FP-301 tubing is typically used as a shrink-fit electrical insulation over cable splices and terminations. It is also used for lightweight wire harness covering, wire marking, wire bundling, component packaging and fire-resistant covering.

Shrink ratio

FP-301 polyolefin tubing has a 2:1 shrink ratio. When freely recovered, the tubing will shrink to 50% of its as-supplied internal diameter. The recovered wall thickness of the tubing is proportional to the degree of recovery.

High expansion-ratio FP-301 tubing meeting AMS-DTL-23053/5* Class 1 requirements for overexpansion is available subject to factory quotation.

Colors

Class 1 (flame retardant): black. Class 2 (non-flame retardant): clear. Also available in Class 1: blue, green, red, white and yellow. Price, minimum order quantity and lead times will vary for these, however.

Standard packaging

Four-foot lengths, large spools (21" diameter) and small spools (8-1/2" diameter).

Ordering information

Order FP-301 tubing by product name, size equivalent to expanded inside diameter, package type and color. Always order the largest size that will shrink snugly over the item to be covered.

Example: FP-301 tubing, 1/4", 4 ft., white.

Standard Sizes and Dimensions

Ordering Size in.	Expanded I.D. (Minimum)		Recovered I.D.† (Maximum)		Recovered Wall Thickness (Nominal)	
	in.	(mm)	in.	(mm)	in.	(mm)
3/64	.046	(1,17)	.023	(0,58)	.016	(0,41)
1/16	.063	(1,60)	.031	(0,79)	.017	(0,43)
3/32	.093	(2,36)	.046	(1,17)	.020	(0,51)
1/8	.125	(3,18)	.062	(1,57)	.020	(0,51)
3/16	.187	(4,75)	.093	(2,36)	.020	(0,51)
1/4	.250	(6,35)	.125	(3,18)	.025	(0,64)
3/8	.375	(9,53)	.187	(4,75)	.025	(0,64)
1/2	.500	(12,70)	.250	(6,35)	.025	(0,64)
3/4	.750	(19,05)	.375	(9,53)	.030	(0,76)
1	1.000	(25,40)	.500	(12,70)	.035	(0,89)
1-1/2	1.500	(38,10)	.750	(19,05)	.040	(1,02)
2	2.000	(50,80)	1.000	(25,40)	.045	(1,14)
3	3.000	(76,20)	1.500	(38,10)	.050	(1,27)
4	4.000	(101,60)	2.000	(50,80)	.055	(1,40)

Note: Dimensions in inches are approximate.

Typical Properties

Applicable Specification

SAE-AMS-DTL-23053/5*†, Class 1, 2; UL File E-39100; CSA LR38227; ABS

Physical

Tensile Strength 2400 PSI
 Ultimate Elongation 400%
 Longitudinal Change ±5%
 Secant Modulus (2%) 13,000 PSI
 Specific Gravity 1.3 (Black)
 .93 (Clear)
 Heat Aging (336 hrs. @ 175°C) Elongation 175%
 Heat Shock (4 hrs. @ 250°C) No dripping, cracking, passes mandrel wrap test

Low Temperature Flexibility (4 hrs. @ -55°C) No cracking
 Flammability Self-extinguish meets UL 224
 All-Tubing Flame Test (Class 1 only)

Technical information provided consists of typical product data and should not be used for specification purposes. Unless otherwise noted, all tests are performed at room temperature.

Electrical

Dielectric Strength 900 V/mil
 Volume Resistivity 10¹⁵ ohm-cm

Chemical

Corrosive Effect Non-corrosive
 Solvent Resistance
 Tensile Strength 1000 PSI
 Dielectric Strength 400 V/mil
 Water Absorption 0.2%
 Fungus Resistance Non-nutrient

* Formerly MIL+23053/5 and MIL-DTL-23053/5

† Product meets functional but not dimensional requirements



Heat Shrink Tubing Kits FP-301

Heat Shrink Tubing Kits and Refill Packs; Shrink Ratio 2:1

Product Description

The 3M™ Heat Shrink Tubing Kits FP-301 are a versatile assortment of flexible polyolefin heat shrink tubing. The kits are available in two different types: Assorted Colors or Black only. Each box is 7" x 11" x 2 1/2" (177.7 x 279.3 x 63.4 mm) of rugged translucent plastic with product and installation information on the cover. Both heat shrink kits allow an engineer, designer or technician to have a complete selection of popular sizes and colors for small projects and product development programs.

The **Assorted Color Kit** has a total of 133 pieces and contains seven colors: black, red, white, yellow, blue, green and clear. The Assorted Color Kit contents, by expanded diameter, are listed in the chart below.

The **Black Kit** contains 102 pieces, all of 6 inch (152.4 mm) lengths. The Black Kit contents, by expanded diameter, are listed in the chart below.

Each diameter has a corresponding refill pack that allows the customer to repurchase a single package of a specific diameter to replenish the kit. FP-301 tubing is a 2:1 shrink ratio polyolefin heat-shrinkable tubing that is widely used in a variety of electronic and electrical applications.

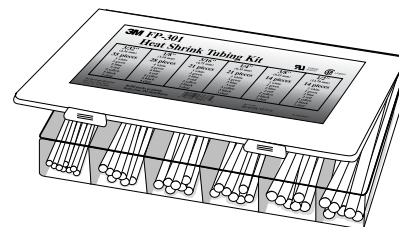

Assorted Colors Kit

Description	Size	Pieces
FP-301	3/32" (2,36 mm)	35
FP-301	1/8" (3,18 mm)	28
FP-301	3/16" (4,75 mm)	21
FP-301	1/4" (6,35 mm)	21
FP-301	3/8" (9,53 mm)	14
FP-301	1/2" (12,70 mm)	14

Assorted Colors* 6" Refill Packs

Ordering Size	Quantity	Packs/Carton
3/32" (2,36 mm)	35 pieces	10
1/8" (3,18 mm)	28 pieces	10
3/16" (4,75 mm)	21 pieces	10
1/4" (6,35 mm)	21 pieces	10
3/8" (9,53 mm)	14 pieces	10
1/2" (12,70 mm)	14 pieces	10

* 7 different colors in each pack

Black Kit

Description	Size	Pieces
FP-301	3/16" (4,8 mm)	30
FP-301	1/4" (6,4 mm)	28
FP-301	3/8" (9,6 mm)	20
FP-301	1/2" (12,7 mm)	14
FP-301	3/4" (19,1 mm)	6
FP-301	1" (25,4 mm)	4

Black 6" Refill Packs

Ordering Size	Quantity	Packs/Carton
3/16" (4,75 mm)	30 pieces	10
1/4" (6,35 mm)	26 pieces	10
3/8" (9,53 mm)	24 pieces	10
1/2" (12,70 mm)	20 pieces	10
3/4" (19,05 mm)	14 pieces	10
1" (25,40 mm)	10 pieces	10



Heat Shrink Tubing FP-301VW

Flexible Polyolefin; Shrink Ratio 2:1

Product description

3M™ Heat Shrink Tubing FP-301VW has the same outstanding balance of electrical, physical and chemical properties as FP-301 tubing and is specially engineered for excellent flame resistance.

FP-301VW tubing meets AMS-DTL-23053/5*, Class 3 requirements. It is UL Recognized and CSA Certified at 600 volts at 125°C (UL File Nos. E-39100 and VW-1; CSA No. 38227, OFT).

FP-301VW tubing is rated for continuous operation from -55°C (-67°F) to 135°C (275°F) and withstands elevated temperatures to 300°C (572°F) for brief periods. Minimum shrink temperature for all FP-301VW tubing is 100°C (212°F).

Typical applications

FP-301VW tubing is ideal for fire-resistant coverings of components and flammable wire assemblies.

Shrink ratio

FP-301VW tubing has a 2:1 shrink ratio. When freely recovered, the tubing will shrink to 50% of its as-supplied internal diameter. The recovered wall thickness of the tubing is proportional to the degree of recovery. High expansion ratios are available subject to factory quotation.

Colors

Standard color is black. Also available in blue, clear, green, red, white and yellow. Price, minimum order quantity and lead time will vary for these, however.

Standard packaging

Four-foot lengths or large spools. Cut pieces available subject to factory quotation.

Ordering information

Order FP-301VW tubing by product name, size equivalent to expanded inside diameter, package type and color. Always order the largest size that will shrink snugly over the item to be covered. *Example: FP-301VW tubing, 1/4", 4 ft., white.*

Standard Sizes and Dimensions

Ordering Size in.	Expanded I.D. (Minimum)		Recovered I.D. (Maximum)		Recovered Wall Thickness (Nominal)	
	in.	(mm)	in.	(mm)	in.	(mm)
3/64	.046	(1,17)	.023	(0,58)	.016	(0,41)
1/16	.063	(1,60)	.031	(0,79)	.017	(0,43)
3/32	.093	(2,36)	.046	(1,17)	.020	(0,51)
1/8	.125	(3,18)	.062	(1,57)	.020	(0,51)
3/16	.187	(4,75)	.093	(2,36)	.020	(0,51)
1/4	.250	(6,35)	.125	(3,18)	.025	(0,64)
3/8	.375	(9,53)	.187	(4,75)	.025	(0,64)
1/2	.500	(12,70)	.250	(6,35)	.025	(0,64)
3/4	.750	(19,05)	.375	(9,53)	.030	(0,76)
1	1.000	(25,40)	.500	(12,70)	.035	(0,89)
1-1/2	1.500	(38,10)	.750	(19,05)	.040	(1,02)
2	2.000	(50,80)	1.000	(25,40)	.045	(1,14)
3	3.000	(76,20)	1.500	(38,10)	.050	(1,27)
4	4.000	(101,60)	2.000	(50,80)	.055	(1,40)

Note: Dimensions in inches are approximate.

Typical Properties

Applicable Specification	
SAE-AMS-DTL-23053/5*, Class 3; UL File E-39100, VW-1; CSA LR38227, OFT	
Physical	Electrical
Tensile Strength 2400 PSI	Dielectric Strength 900 V/mil
Ultimate Elongation 400%	Volume Resistivity 10 ¹⁵ ohm-cm
Longitudinal Change +1, -10%	
Secant Modulus (2%) 13,000 PSI	Chemical
Specific Gravity 1.5	Corrosive Effect Non-corrosive
Heat Aging Elongation 175% (168 hrs. @ 175°C)	Solvent Resistance
Heat Shock No dripping, cracking, (4 hrs. @ 250°C)	Tensile Strength 1000 PSI
	Dielectric Strength 400 V/mil
	Water Absorption 0.2%
	Fungus Resistance Non-nutrient
Low Temperature Flexibility (4 hrs. @ -55°C) No cracking	
Flammability Self-extinguish meets UL 224 VW-1 Test	
Technical information provided consists of typical product data and should not be used for specification purposes. Unless otherwise noted, all tests are performed at room temperature.	

* Formerly MIL+23053/5 and MIL-DTL-23053/5



Heat Shrink Tubing VFP-876

Very Flexible Polyolefin; Shrink Ratio 2:1

Product description

3M™ Heat Shrink Tubing VFP-876 is one of the most flexible of the heat-shrinkable, polyolefin tubings. Rated at 135°C (275°F), VFP-876 tubing has been engineered to offer a low shrink temperature of 100°C (212°F). This allows the tubing to shrink rapidly, thereby minimizing heat exposure and possible damage to sensitive substrate materials or components.

VFP-876 tubing meets AMS-DTL-23053/5*, Class 1; and AMS-3587 and is UL Recognized (UL File No. E-39100). It is rated for continuous operation from -55°C (-67°F) to 135°C (275°F) and withstands elevated temperatures to 300°C (572°F) for brief periods.

Typical applications

The extra flexibility and low shrink temperature of VFP-876 tubing make it ideal for shrink-fit jacketing and insulation of flexible wire bundles and sensitive components.

Shrink ratio

VFP-876 tubing has a 2:1 shrink ratio. When freely recovered, the tubing will shrink to 50% of its as-supplied internal diameter. The recovered wall thickness of the tubing is proportional to the degree of recovery. High expansion-ratio VFP-876 tubing is available subject to factory quotation.

Standard colors

VFP-876 tubing (flame retardant)—black, white and yellow. Other colors and clear available subject to factory quotation.

Standard packaging

Four-foot lengths or large spools. Cut pieces available subject to factory quotation.

Ordering information

Order VFP-876 tubing by product name, size equivalent to expanded inside diameter, package type and color. Always order the largest size that will shrink snugly over the item to be covered.
Example: VFP-876 tubing, 1/4", 4 ft., white.

Standard Sizes and Dimensions

Ordering Size in.	Expanded I.D. (Minimum)		Recovered I.D. (Maximum)		Recovered Wall Thickness (Nominal)	
	in.	(mm)	in.	(mm)	in.	(mm)
3/64	.046	(1,17)	.023	(0,58)	.016	(0,41)
1/16	.063	(1,60)	.031	(0,79)	.017	(0,43)
3/32	.093	(2,36)	.046	(1,17)	.020	(0,51)
1/8	.125	(3,18)	.062	(1,57)	.020	(0,51)
3/16	.187	(4,75)	.093	(2,36)	.020	(0,51)
1/4	.250	(6,35)	.125	(3,18)	.025	(0,64)
3/8	.375	(9,53)	.187	(4,75)	.025	(0,64)
1/2	.500	(12,70)	.250	(6,35)	.025	(0,64)
3/4	.750	(19,05)	.375	(9,53)	.030	(0,76)
1	1.000	(25,40)	.500	(12,70)	.035	(0,89)
1-1/2	1.500	(38,10)	.750	(19,05)	.040	(1,02)
2	2.000	(50,80)	1.000	(25,40)	.045	(1,14)

Note: Dimensions in inches are approximate.

Typical Properties

Applicable Specification

SAE-AMS-DTL-23053/5*, Class 1; UL File E-39100; CSA LR38227

Physical

Tensile Strength 2100 PSI
 Ultimate Elongation 450%
 Longitudinal Change ±5%
 Secant Modulus (2%) 11,000 PSI
 Specific Gravity 1.3
 Heat Aging Elongation (168 hrs. @ 175°C) (200% min.) 250%
 Heat Shock No dripping, cracking, passes mandrel wrap test (4 hrs. @ 250°C)
 Low Temperature Flexibility (4 hrs. @ -55°C) No cracking
 Flammability Self-extinguish meets UL 224 All-Tubing Flame Test

Electrical

Dielectric Strength 800 V/mil
 Volume Resistivity 10¹⁴ ohm-cm

Chemical

Corrosive Effect Non-corrosive
 Solvent Resistance
 Tensile Strength 750 PSI
 Dielectric Strength 400 V/mil
 Water Absorption 0.2%
 Fungus Resistance Non-nutrient

Technical information provided consists of typical product data and should not be used for specification purposes. Unless otherwise noted, all tests are performed at room temperature.

* Formerly MIL+23053/5 and MIL-DTL-23053/5



Heat Shrink Tubing SFTW-203

Very Flexible Polyolefin; Shrink Ratio 3:1

Product description

3M™ Heat Shrink Tubing SFTW-203 is a 3:1 shrink ratio tubing that offers an outstanding balance of electrical, physical and chemical properties for a wide variety of industrial and military applications. SFTW-203 tubing is made of very flexible, heat-shrinkable polyolefin which is mechanically tough, chemically resistant, and can be easily surface printed.

SFTW-203 tubing has been engineered to offer a low shrink temperature of 100°C (212°F). This allows the tubing to shrink rapidly, and minimizes heat exposure and possible damage to temperature sensitive substrates.

SFTW-203 tubing meets the performance requirements of AMS-DTL-23053/5* Class 1 and is UL Recognized (File No. E48398) for flame retardance. It is rated for continuous operation from -55°C (-67°F) to 135°C (275°F), and withstands elevated temperatures of 300°C (572°F) for brief periods.

Typical applications

The extra flexibility and low shrink temperature of SFTW-203 tubing make it ideal for shrink-fit jacketing and insulation of flexible wire bundles and temperature sensitive components. The 3:1 shrink ratio makes SFTW-203 tubing the insulation of choice for end terminations where the connector body is larger than the cable and for repair applications where the tubing must be slid over a connector. SFTW-203 tubing can also be used to insulate an oversized component in line to the wiring.

Shrink ratio

SFTW-203 tubing has a 3:1 shrink ratio. When freely recovered, the tubing will shrink to 33% of its as-supplied internal diameter. The recovered wall thickness of the tubing is proportional to the degree of recovery.

Standard colors

Black.

Standard packaging

Boxes of four-foot lengths, or large spools. Cut pieces subject to factory quotation.

Ordering information

Order SFTW-203 tubing by product name, size equivalent to expanded inner diameter, color, and package type. Always order the largest size that will shrink-fit snugly over the item to be covered.

Example: SFTW-203 tubing, 1/2", black, 4 ft. lengths.

Standard Sizes and Dimensions

Ordering Size in.	Expanded I.D. (Minimum)		Recovered I.D. (Maximum)		Recovered Wall Thickness (Nominal)	
	in.	(mm)	in.	(mm)	in.	(mm)
1/16	.059	(1,5)	.020	(0,5)	.018	(0,45)
1/8	.118	(3,0)	.039	(1,0)	.022	(0,55)
1/4	.236	(6,0)	.079	(2,0)	.026	(0,65)
3/8	.354	(9,0)	.118	(3,0)	.030	(0,75)
1/2	.472	(12,0)	.157	(4,0)	.030	(0,75)
3/4	.709	(18,0)	.236	(6,0)	.033	(0,83)
1	.945	(24,0)	.315	(8,0)	.039	(1,00)
1-1/2	1.535	(39,0)	.512	(13,0)	.045	(1,15)

Note: Dimensions in inches are approximate.

Typical Properties

Applicable Specification

UL File E48398; CSA LR 38227; Meets functional requirements of SAE-AMS-DTL 23053/5, Class 1

Physical

Tensile Strength 2600 PSI
 Ultimate Elongation 400%
 Longitudinal Change ±5%
 Secant Modulus (2% elongation) 8700 PSI
 Specific Gravity 1.29
 Heat Shock (4 hrs. @ 250°C) No cracking, flowing or dripping
 Water Absorption 0.2%
 Heat Aging (168 hrs. @ 158°C) Elongation 350%
 Low Temperature Flexibility (4 hrs. @ -55°C) No cracking
 Flammability Self extinguishing

Electrical

Dielectric Strength 700 V/mil
 Volume Resistivity 10¹⁵ ohm-cm

Chemical

Corrosive effect Non-corrosive
 Solvent Resistance
 Tensile Strength 1100 PSI
 Dielectric Strength 400 V/mil
 Fungus Resistance Inert

Technical information provided consists of typical product data and should not be used for specification purposes. Unless otherwise noted, all tests are performed at room temperature.

3M™ Adhesive-Lined Tubing



- Outer wall provides abrasion resistance
- Inner wall forms environmental seal against moisture penetration
- Meets UL/CSA specifications
- Meets military specifications
- Flame retardant
- Choice of shrink ratios





Heat Shrink Tubing MW

Adhesive-Lined Semi-Rigid Polyolefin; Shrink Ratio 2.5:1

Product description

3M™ Heat Shrink Tubing MW is a semi-rigid, 110°C (230°F) heat-shrinkable polyolefin tubing that is co-extruded and selectively cross-linked to provide an integral, meltable inner wall.

When heated in excess of 135°C (275°F), the inner meltable wall of the tubing is simultaneously softened and forced by the shrink action into intimate contact with all underlying surfaces, interstices and small voids. Upon cooling, the MW tubing provides a tough protective and insulating barrier, highly resistant to penetration by moisture and the attack of chemicals and solvents.

MW tubing is rated for continuous operation at temperatures from -55°C (-67°F) to 110°C (230°F) and will withstand higher operating temperatures for brief periods. Adhesive reflow will occur at temperatures above 80°C (176°F).

Typical applications

Applications for MW tubing include braided-shield pigtailed, electrical wiring, mechanical assemblies, electronic components, electrical wire splices, breakouts, connections, solder joints, delicate wire terminations, end-sealing of electrical cables and rigid tubings.

For installations that may require rework, retrofit or repair in the field, MW tubing offers the extra advantage of easy removability. For circuit and component identification purposes, the tubings readily accept marking by means of print-wheel or hot-stamp techniques.

Shrink ratio

MW tubing has a 2.5:1 shrink ratio. When fully recovered, the tubing will shrink to 40% of its original diameter. The recovered wall thickness of the tubing is proportional to the degree of recovery.

Colors

Standard color is black. Also available in blue, clear, red, white and yellow. Price, minimum order quantity and lead time will vary for these, however.

Standard packaging

Four-foot lengths. Cut pieces and other lengths (including spooled) are available subject to factory quotation.

Ordering information

Order MW tubing by product name, size equivalent to the expanded inside diameter, package type and color. Other sizes are available subject to factory quotation. Always order the largest size that will shrink snugly over the item to be covered. *Example: MW tubing, 1/4", 4 ft., black.*

Standard Sizes and Dimensions

Ordering Size in.	Expanded I.D. (Minimum)		Recovered I.D. (Maximum)		Total Recovered Wall Thickness (Nominal)		Meltable Recovered Wall Thickness (Nominal)	
	in.	(mm)	in.	(mm)	in.	(mm)	in.	(mm)
1/8	.125	(3,18)	.023	(0,58)	.038	(0,97)	.020	(0,51)
3/16	.187	(4,75)	.060	(1,52)	.043	(1,09)	.025	(0,64)
1/4	.250	(6,35)	.080	(2,03)	.047	(1,19)	.027	(0,69)
3/8	.375	(9,53)	.13	(3,43)	.050	(1,27)	.030	(0,76)
1/2	.500	(12,70)	.195	(4,95)	.055	(1,40)	.035	(0,89)
3/4	.750	(19,05)	.313	(7,95)	.065	(1,65)	.040	(1,02)
1	1.000	(25,40)	.400	(10,16)	.075	(1,91)	.040	(1,02)

Note: Dimensions in inches are approximate.

Typical Properties

Applicable Specification

SAE-AMS-DTL-23053/4,* Class 1; UL File E-157227; CSA LR38227

Physical

Tensile Strength 2200 PSI
 Ultimate Elongation 400%
 Longitudinal Change +1, -10%
 Secant Modulus (2%) 27,000 PSI
 Specific Gravity 1.0
 *Heat Aging Elongation 175%
 (168 hrs. @ 175°C)
 *Heat Shock No dripping,
 (4 hrs. @ 250°C) flowing,
 cracking
 *Low Temperature Flexibility
 (4 hrs. @ -55°C) No cracking

Electrical

Dielectric Strength 900 V/mil
 Volume Resistivity 10¹⁵ ohm-cm

Chemical

Corrosion Resistance Non-corrosive
 Fungus Resistance Non-nutrient
 Water Absorption 0.1%
 Fluid Resistance
 JR4 Skydrol 600
 Solution Gasoline > 1500 PSI
 Hydraulic Fluid @ 600 V/mil

Technical information provided consists of typical product data and should not be used for specification purposes. Unless otherwise noted, all tests are performed at room temperature.

* Outer wall only.

** Formerly MIL+23053/4 and MIL-DTL-23053/4



Heat Shrink Tubing EPS-200

Adhesive-Lined Flexible Polyolefin; Shrink Ratio 2:1

Product description

3M™ Heat Shrink Tubing EPS-200 is a 2:1 thin-wall tubing offering the advantages of integral adhesive-lined construction. The tubing is made from a flame-retardant, flexible polyolefin with a thin layer of special thermoplastic adhesive. The heat-shrinkable outer wall is selectively cross-linked while maintaining the high flow and excellent adhesion of the inner sealant liner.

When heated in excess of 121°C (250°F), EPS-200 tubing rapidly shrinks to a skintight fit, forcing the melted adhesive lining to flow and cover the substrate. The adhesive forms a flexible bond with a wide variety of rubbers, plastics and metals. Upon cooling, the adhesive solidifies forming a durable, non-drying, flexible and water resistant barrier. EPS-200 tubing is rated for operation at -55°C (-67°F) to 110°C (230°F). Adhesive reflow will occur at temperatures above 80°C (176°F).

Typical applications

EPS-200 tubing offers convenient protection of electronic components, wire splices or bundling of wires. Automotive, truck and marine wiring splices and connections are quickly and easily protected from harsh environments.

Shrink ratio

EPS-200 tubing has a 2:1 shrink ratio. When freely recovered, the tubing will shrink to 50% of its original diameter. The recovered wall thickness of the tubing is proportional to the degree of recovery.

Colors

Standard color is black. Clear, red and yellow also are available. Price, minimum order quantity and lead time will vary for these, however. (Clear tubing is not flame retardant.)

Standard packaging

Four-foot lengths. Cut pieces and other lengths (including spooled) are available subject to factory quotation.

Ordering information

Order EPS-200 tubing by product name, size equivalent to the expanded inside diameter, package type and color. Other sizes are available subject to factory quotation. Always order the largest size that will shrink snugly over the item to be covered. *Example: EPS-200 tubing, 3/8", 4 ft., black.*

Standard Sizes and Dimensions

Ordering Size in.	Expanded I.D. (Minimum)		Recovered I.D. (Maximum)		Total Recovered Wall Thickness (Nominal)		Meltable Recovered Wall Thickness (Nominal)	
	in.	(mm)	in.	(mm)	in.	(mm)	in.	(mm)
1/8	.125	(3,18)	.063	(1,60)	.027	(0,68)	.004	(0,10)
3/16	.187	(4,75)	.093	(2,36)	.027	(0,68)	.004	(0,10)
1/4	.250	(6,35)	.125	(3,18)	.030	(0,76)	.005	(0,13)
3/8	.375	(9,53)	.187	(4,75)	.031	(0,79)	.005	(0,13)
1/2	.500	(12,70)	.250	(6,35)	.032	(0,81)	.006	(0,15)
3/4	.750	(19,05)	.375	(9,53)	.037	(0,94)	.006	(0,15)
1	1.000	(25,40)	.500	(12,70)	.046	(1,17)	.008	(0,20)
1-1/2	1.500	(38,10)	.750	(19,05)	.049	(1,24)	.008	(0,20)
2	2.000	(50,80)	1.000	(25,40)	.060	(1,52)	.015	(0,38)

Note: Dimensions in inches are approximate.

Typical Properties

Applicable Specification

SAE-AMS-DTL-23053/4*, Class 2; UL File E-39100; CSA LR38227**

Physical

Tensile Strength 2100 PSI
 Ultimate Elongation 450%
 Longitudinal Change +1, -5%
 Secant Modulus (2%) 17,000 PSI
 Specific Gravity 1.3
 *Heat Aging Elongation 175%
 (168 hrs. @ 175°C)
 *Heat Shock No dripping,
 (4 hrs. @ 225°C) flowing,
 cracking
 *Low Temperature Flexibility
 (4 hrs. @ -55°C) No cracking
 Flammability Self-extinguish
 meets UL 224
 All-Tubing Flame
 Test (jacket)

Chemical

Corrosion Resistance
 (Copper mirror) Non-corrosive
 Fungus Resistance Non-nutrient
 Water Absorption 0.3%
 Fluid Resistance Excellent

Adhesive

Peel Strength, pli
 Polyethylene 30
 PVC 10
 Lead 15
 Aluminum 40
 Corrosive Effect
 (Copper mirror) Non-corrosive

Electrical

Dielectric Strength 800 V/mil
 Volume Resistivity 10¹⁴ ohm-cm

Technical information provided consists of typical product data and should not be used for specification purposes. Unless otherwise noted, all tests are performed at room temperature.

* Outer wall only.

** Formerly MIL+23053/4 and MIL-DTL-23053/4



Heat Shrink Tubing EPS-300

Adhesive-Lined Flexible Polyolefin; Shrink Ratio 3:1

Product description

3M™ Heat Shrink Tubing EPS-300 is a thin-wall tubing offering the advantages of integral, adhesive-lined construction. The tubing is made from flame-retardant, flexible polyolefin with an internal layer of special thermoplastic adhesive. The heat-shrinkable outer wall is selectively cross-linked, while the adhesive maintains high flow and excellent adhesion characteristics.

When heated in excess of 121°C (250°F), EPS-300 tubing rapidly shrinks to a skintight fit, forcing the melted adhesive to flow and cover the substrate. The adhesive forms a flexible bond with a wide variety of rubbers, plastics and metals. Upon cooling, the adhesive solidifies, forming a durable, non-drying, flexible and water resistant barrier. EPS-300 tubing is rated for operation at -55°C (-67°F) to 110°C (230°F). Adhesive reflow will occur at temperatures above 80°C (176°F).

Typical applications

EPS-300 tubing offers superb environmental protection for electronic components, wire splices, wire bundles and harness breakouts. Automotive, truck and marine wire splices and harness breakouts are also quickly and easily protected from a variety of harsh environments.

Shrink ratio

EPS-300 tubing has a 3:1 shrink ratio. When freely recovered, the tubing will shrink to 33% of its original diameter. The recovered wall thickness of the tubing is proportional to the degree of recovery.

Colors

Standard colors are black and red. Clear, white and yellow are available by special order. Price, minimum order quantity and lead time will vary for these, however.

Clear tubing is not flame retardant or UL approved.

Standard packaging

Four-foot lengths. Cut pieces and other lengths (including spooled) are available subject to factory quotation.

Ordering information

Order EPS-300 tubing by product name, size equivalent to the expanded inside diameter, package type and color. Other sizes are available subject to factory quotation. Always order the largest size that will shrink snugly over the item to be covered. *Example: EPS-300 tubing, 1/2", 4 ft., black.*

Standard Sizes and Dimensions

Ordering Size in.	Expanded I.D. (Minimum)		Recovered I.D. (Maximum)		Total Recovered Wall Thickness (Nominal)		Meltable Recovered Wall Thickness (Nominal)	
	in.	(mm)	in.	(mm)	in.	(mm)	in.	(mm)
1/8	.125	(3,18)	.040	(1,02)	.040	(1,02)	.020	(0,51)
3/16	.187	(4,75)	.062	(1,57)	.040	(1,02)	.020	(0,51)
1/4	.250	(6,35)	.080	(2,03)	.040	(1,02)	.020	(0,51)
3/8	.375	(9,53)	.120	(3,05)	.055	(1,40)	.025	(0,62)
1/2	.500	(12,70)	.160	(4,06)	.070	(1,78)	.030	(0,76)
3/4	.750	(19,05)	.250	(6,35)	.085	(2,16)	.035	(0,89)
1	1.000	(25,40)	.320	(8,13)	.100	(2,54)	.040	(1,02)
1-1/2	1.500	(38,10)	.510	(12,95)	.100	(2,54)	.040	(1,02)

Note: Dimensions in inches are approximate.

Typical Properties

Applicable Specification

UL File E-157227; ABS; CSA LR38227

Physical

Tensile Strength 2100 PSI
 Ultimate Elongation 450%
 Longitudinal Change +1, -15%
 Secant Modulus (2%) 17,000 PSI
 Specific Gravity 1.3
 *Heat Aging Elongation 175% (168 hrs. @ 175°C)
 *Heat Shock No dripping, (4 hrs. @ 225°C) flowing, cracking
 *Low Temperature Flexibility (4 hrs. @ -55°C) No cracking
 Flammability Self-extinguish meets UL 224 All-Tubing Flame Test (jacket)

Chemical

Corrosion Resistance (Copper mirror) Non-corrosive
 Fungus Resistance Non-nutrient
 Water Absorption 0.3%
 Fluid Resistance Excellent

Adhesive

Peel Strength, pli Polyethylene 30
 PVC 10
 Lead 15
 Aluminum 40
 Corrosive Effect (Copper mirror) Non-corrosive

Electrical

Dielectric Strength 700 V/mil
 Volume Resistivity 10¹⁴ ohm-cm

Technical information provided consists of typical product data and should not be used for specification purposes. Unless otherwise noted, all tests are performed at room temperature.

* Outer wall only.

** Formerly MIL+23053/4 and MIL-DTL-23053/4



Heat Shrink Tubing EPS-400

Adhesive-Lined Semi-Rigid Polyolefin; Shrink-Ratio 4:1

Product description

3M™ Heat Shrink Tubing EPS-400 is a semi-rigid tubing offering the advantages of integral, adhesive-lined construction. The tubing is made from flame-retardant, flexible polyolefin with an internal layer of special thermoplastic adhesive. The heat-shrinkable outer wall is selectively cross-linked, while the adhesive maintains high flow and excellent adhesion characteristics.

When heated in excess of 121°C (250°F), EPS-400 tubing rapidly shrinks to a skintight fit, forcing the melted adhesive to flow and cover the substrate. Upon cooling, the adhesive solidifies, forming a durable, non-drying, flexible and water resistant barrier. EPS-400 tubing is rated for operation at -55°C (-67°F) to 110°C (230°F). Adhesive reflow will occur at temperatures above 80°C (176°F).

Typical applications

EPS-400 tubing offers excellent environmental protection for electronic components, wire splices, wire bundles and harness breakouts. Automotive, truck and marine wire splices and harness breakouts are also quickly and easily protected from a variety of harsh environments.

Shrink ratio

EPS-400 tubing has a 4:1 shrink ratio. When freely recovered, the tubing will shrink to 25% of its as-supplied diameter. The recovered wall thickness of the tubing is proportional to the degree of recovery.

Standard color

Black.

Standard packaging

Four-foot lengths. Cut pieces are available subject to factory quotation.

Ordering information

Order EPS-400 tubing by product name, size equivalent to the expanded inside diameter, package type and color. Always order the largest size that will shrink snugly over the item to be covered. *Example: EPS-400 tubing, .300", 4 ft., black.*

Standard Sizes and Dimensions

Ordering Size in.	Expanded I.D. (Minimum)		Recovered I.D. (Maximum)		Recovered Melt Wall (Nominal)		Recovered Outer Wall (Minimum)	
	in.	(mm)	in.	(mm)	in.	(mm)	in.	(mm)
.300	.300	(7,62)	.060	(1,52)	.033	(0,84)	.028	(0,71)
.350	.350	(8,89)	.080	(2,03)	.038	(0,97)	.033	(0,84)
.450	.450	(11,43)	.105	(2,67)	.043	(1,09)	.053	(1,35)
.700	.700	(17,78)	.175	(4,45)	.060	(1,52)	.055	(1,40)

Note: Dimensions in inches are approximate.

Typical Properties

Applicable Specification

UL File E-157227; CSA LR38227

Physical

Tensile Strength 1900 PSI
 Ultimate Elongation 400%
 Longitudinal Change +1, -10%
 Secant Modulus (2%) 33,000 PSI
 Specific Gravity 1.25

*Heat Aging Elongation 175%
 (168 hrs. @ 175°C)

*Heat Shock No dripping,
 (4 hrs. @ 225°C) flowing,
 cracking

*Low Temperature Flexibility
 (4 hrs. @ -55°C) No cracking

Flammability Self-extinguish

Corrosion Resistance
 (Copper mirror) Non-corrosive
 Fungus Resistance Non-nutrient
 Water Absorption 0.3%
 Fluid Resistance Excellent

Adhesive

Peel Strength, pli
 Polyethylene 30
 PVC 10
 Lead 15
 Aluminum 40
 Corrosive Effect
 (Copper mirror) Non-corrosive

Electrical

Dielectric Strength 700 V/mil
 Volume Resistivity 10¹⁴ ohm-cm

Chemical

Material testing performed to MIL-DTL-23053/4. Technical information provided consists of typical product data and should not be used for specification purposes. Unless otherwise noted, all tests are performed at room temperature.

* Outer wall only.



Heat Shrink Tubing TMW

Adhesive-Lined Translucent Semi-Rigid Polyolefin

Product description

3M™ Heat Shrink Tubing TMW is a semi-rigid, translucent heat-shrinkable polyolefin tubing that is co-extruded and selectively cross-linked with an integral, meltable inner wall.

When heated in excess of 135°C (275°F), the adhesive inner wall of the tubing is softened and forced by the shrinking action of the outer wall into contact with all underlying surfaces and small voids. The adhesive forms a flexible bond with a wide variety of rubbers, plastics and metals. Upon cooling, TMW tubing provides a tough, protective and insulating barrier, highly resistant to penetration by moisture, chemicals and solvents.

TMW tubing is rated for continuous operation at temperatures from -55°C (-67°F) to 110°C (230°F) and will withstand higher operating temperatures for brief periods. Adhesive reflow will occur at temperatures above 80°C (176°F).

Typical applications

The primary application for 3M TMW tubing is in the manufacture of heat shrink butt connectors, disconnects, ring terminals and fork terminals. Other applications include braided-shield pigtails, mechanical assemblies, electronic components, electrical wire splices, breakouts, solder joints, delicate wire terminations and end-sealing of electrical cables.

3M TMW tubing can withstand the crimping force of standard crimp tools without puncture or splitting during heat recovery. The tubing remains round when cut, making it ideal for use in high speed processing and assembly equipment.

Standard colors

TMW tubing is available color coded by diameter. Please see chart below.

Standard packaging

TMW tubing is supplied in cut pieces. Standard lengths are available in 10,000 piece cartons, other lengths and diameters are available subject to factory quotation.

Ordering Information

Order TMW tubing in the size equivalent to the expanded inside diameter required. Always order the largest size that will shrink snugly over the component to covered. Non-standard diameters and cut lengths are available subject to factory quotation. *Example: TMW Red tubing 183-1.500.*

Typical Properties

Applicable Specification – UL File E-157227; CSA LR38227					
Physical		Electrical		Chemical	
Tensile Strength	2500 PSI	Dielectric Strength	900 V/mil	Corrosive Effect	Non-corrosive
Ultimate Elongation	400%	Volume Resistivity	10 ¹⁴ ohm-cm	Solvent Resistance	
Longitudinal Change	+1, -10%			Tensile Strength	1000 PSI
Secant Modulus (2%)	32,000 PSI			Dielectric Strength	400 V/mil
Specific Gravity	1.0			Water Absorption	0.1%
*Heat Aging	168 hrs. @ 175°C			Fungus Resistance	Non-nutrient
	Elongation 175%			Fluid Resistance	
*Heat Shock	No dripping,			Gasoline	>600 PSI
(4 hrs. @ 250°C)	cracking, flowing			Hydraulic Fluid @JP4	600 V/mil
*Low Temperature Flexibility	No cracking			Skydrol 600	
(4 hrs. @ -55°C)					

Technical information provided consists of typical product data and should not be used for specification purposes. Unless otherwise noted, all tests are performed at room temperature.

* Outer wall only.

Standard Sizes and Dimensions (without adhesive)

Product Number/Color	Expanded I.D.		Recovered I.D.		Total Recovered Wall Thickness (Nominal)		Meltable Recovered Wall (Nominal)		Standard Cut Length		Cut Length Tolerance (+/-)	
	in.	(mm)	in.	(mm)	in.	(mm)	in.	(mm)	in.	(mm)	in.	(mm)
TMW.183x3/4-Red-Bulk	0.183	(4,65)	0.060	(1,52)	0.049	(1,24)	0.018	(0,46)	0.750	(19,05)	0.020	(0,51)
TMW.183x1.5-Red-Bulk	0.183	(4,65)	0.060	(1,52)	0.049	(1,24)	0.018	(0,46)	1.500	(38,10)	0.030	(0,76)
TMW.220x3/4-Blue-Bulk	0.220	(5,59)	0.070	(1,78)	0.049	(1,24)	0.018	(0,46)	0.750	(19,05)	0.020	(0,51)
TMW.220x1.5-Blue-Bulk	0.220	(5,59)	0.070	(1,78)	0.049	(1,24)	0.018	(0,46)	1.500	(38,10)	0.030	(0,76)
TMW.255x7/8-Yellow-Bulk	0.255	(6,47)	0.095	(2,41)	0.059	(1,50)	0.018	(0,46)	0.875	(22,22)	0.020	(0,51)
TMW.255x1.7-Yellow-Bulk	0.255	(6,47)	0.095	(2,41)	0.059	(1,50)	0.018	(0,46)	1.700	(43,18)	0.030	(0,76)
TMW.330-1" Pink	0.330	(8,38)	0.165	(4,19)	0.059	(1,50)	0.018	(0,46)	1.000	(25,40)	0.020	(0,51)
TMW.330-1.85" Pink	0.330	(8,38)	0.165	(4,19)	0.059	(1,50)	0.018	(0,46)	1.850	(46,99)	0.030	(0,76)



Heat Shrink Tubing TES

Adhesive Lined Semi-Rigid Clear Polyolefin for Automotive Applications;
 Shrink Ratio 4:1

All-Weather, Heat-Shrinkable, Dual Wall, Polyolefin Tubing for Automotive Wire Harnesses

- Semi-rigid polyolefin
- Provides excellent strain relief
- Functional over wide temperature range
- Puncture resistant
- Resistant to salt water, automotive fluids and corrosive chemicals

Product Description

3M™ Heat Shrink Tubing TES is a co-extruded, dual wall product. It is a composite of a polyolefin shrinkable outer wall and a thermoplastic adhesive inner wall. TES tubing resists degradation when exposed to typical automotive and marine environments, such as severe vibration, extreme temperature changes, moisture or automotive fluids.

Typical Application

Semi-rigid TES tubing is ideal for applications requiring moisture sealing, mechanical protection and strain relief.

The adhesive layer is compatible with typical wire insulation and is intended for moisture sealing and insulation of automotive, RV, truck, trailer, tractor, heavy equipment and marine wire splices, in-line components, fusible links and terminals.

This clear tubing is ideal for applications requiring inspection of the underlying weld or component.

Shrink Ratio

TES tubing has a 4:1 shrink ratio. When fully recovered, the tubing will shrink to 25% of its original diameter. The recovered wall thickness of the tubing is proportional to the degree of recovery.

Standard Color

TES tubing is supplied in clear and is color-coded by diameter with printed squares to aid in identification.

Standard Packaging

Cut pieces and four-foot lengths. See price pages for standard lengths and carton quantities. Other sizes, lengths and packaging options are available, subject to factory quotation.

Printing

Custom printing to identify resistors, diodes and other components is available, subject to factory quotation.

Ordering Information

Order TES tubing by product name and part number and cut length.
Example: TES tubing, .300, 55 mm length, white.

Standard Sizes and Dimensions

Ordering Size	Minimum Expanded I.D.	Maximum Recovered I.D.	Nominal Recovered Melt Wall	Minimum Recovered Outer Wall	Color Code
.220	.220"	.045"	.030"	.027"	Yellow
.300	.300"	.060"	.033"	.028"	White
.350	.350"	.080"	.038"	.033"	Green
.450	.450"	.105"	.043"	.053"	Red
.700	.700"	.175"	.060"	.053"	Orange

Note: Dimensions in inches are approximate.

Typical Properties*

Physical		Electrical	
Tensile Strength	2450 PSI	Dielectric Strength ⁵	500 V/mil
Ultimate Elongation ¹	475%	(outer wall)	
2% Secant Modulus ²	16,500 PSI	Dielectric Withstand	1000
Longitudinal Change ¹	+0%, -10%		Volts AC
Specific Gravity ³	0.97	Current Leakage	< 0.250
(outer wall)			Microamps
Heat Aging	135°C		
(Adhesive softens)			
Thermal Cycle	5°C to 135°C	Chemical	
Vibration	24 hours	Auto Fluid Compatibility	8 fluids
Cold Flex	-30°C		

ESB-M99D56-Ford
 MS-DB56-Chrysler

*Not recommended for specification purposes. Product specifications will be provided upon request.

3M test methods available upon request.

Test Methods

¹ASTM-D 2671

²ASTM-D 882 Procedure A

³ASTM-D 792

⁴ASTM-D 2671 Procedure B

⁵ASTM-D 149



Heat Shrink Tubing SMS

Adhesive Lined Semi-Rigid Polyolefin for Automotive Applications; Shrink Ratio 4:1

All-Weather, Heat-Shrinkable, Dual Wall, Polyolefin Tubing for Automotive Wire Harnesses

- Semi-rigid polyolefin
- Provides excellent strain relief
- Functional over wide temperature range
- Puncture resistant
- Resistant to salt water, automotive fluids and corrosive chemicals
- Fire retardant

Product Description

3M™ Heat Shrink Tubing SMS is a co-extruded, dual wall product. It is a composite of a polyolefin shrinkable outer wall and a thermoplastic adhesive inner wall. SMS tubing resists degradation when exposed to typical automotive and marine environments, such as severe vibration, temperature changes, moisture or automotive fluids.

Typical Application

Semi-rigid SMS tubing is ideal for applications requiring moisture sealing, mechanical protection and strain relief. The adhesive layer is compatible with typical wire insulation and is intended for moisture sealing and insulation of automotive, RV, truck, trailer, tractor, heavy equipment and marine wire splices, in-line components, fusible links and terminals.

Shrink Ratio

SMS tubing has a 4:1 shrink ratio. When fully recovered, the tubing will shrink to 25% of its original diameter. The recovered wall thickness of the tubing is proportional to the degree of recovery.

Standard Color

The tubing is supplied in black and is color-coded by diameter with printed squares to aid in identification.

Standard Packaging

Cut pieces and four-foot lengths. See price pages for standard lengths and carton quantities. Other sizes, lengths and packaging options are available, subject to factory quotation.

Printing

Custom printing to identify resistors, diodes and other components is available, subject to factory quotation.

Ordering Information

Order SMS tubing by product name and part number and cut length. *Example: SMS tubing, .300, 55 mm length, white.*

Standard Sizes and Dimensions

Ordering Size	Minimum Expanded I.D.	Maximum Recovered I.D.	Nominal Recovered Melt Wall	Minimum Recovered Outer Wall	Color Code
.220	.220"	.045"	.030"	.027"	Yellow
.300	.300"	.060"	.033"	.028"	White
.350	.350"	.080"	.038"	.033"	Green
.450	.450"	.105"	.043"	.053"	Red
.700	.700"	.175"	.060"	.053"	Orange

Note: Dimensions in inches are approximate.

Typical Properties*

Physical		Cold Flex	-30°C
Tensile Strength	1900 PSI	Electrical	
Ultimate Elongation ¹	350%	Dielectric Strength ⁵	500 V/mil (outer wall)
2% Secant Modulus ²	35,000 PSI	Dielectric Withstand	1000 Volts AC
Longitudinal Change ¹	+0%, -10%	Current Leakage	< 0.250 Microamps
Specific Gravity ³ (outer wall)	1.25	Chemical	
Flammability ⁴	Self-extinguishing	Auto Fluid Compatibility	8 fluids
Heat Aging	135°C (Adhesive softens)		
Thermal Cycle	5°C to 135°C		
Vibration	24 hours		

ESB-M99D56-Ford
MS-DB56-Chrysler

*Not recommended for specification purposes. Product specifications will be provided upon request.

3M test methods available upon request.

Test Methods

¹ASTM-D 2671

²ASTM-D 882 Procedure A

³ASTM-D 792

⁴ASTM-D 2671 Procedure B

⁵ASTM-D 149

3M™ Special Purpose Tubing



- High temperature applications
- Outstanding chemical and solvent resistance
- Abrasion and tear resistant
- Flame retardant
- Meets UL/CSA specifications
- Meets military specifications

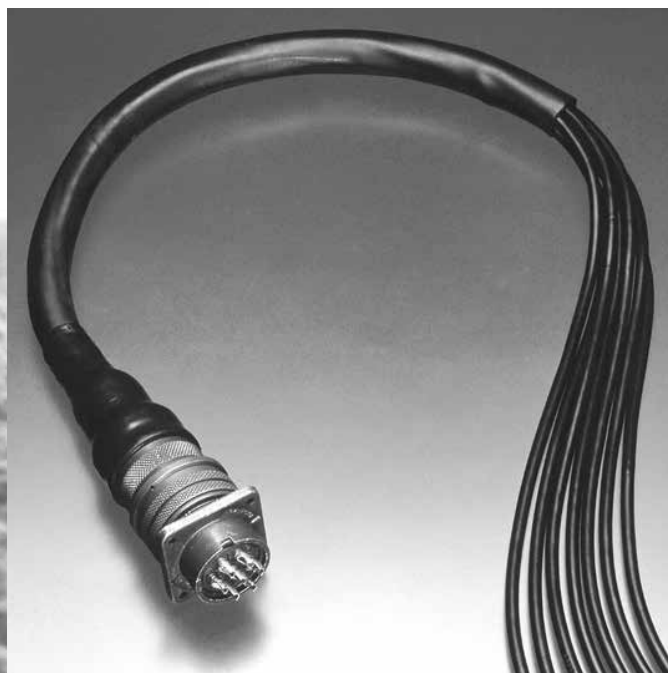



MFP Heat Shrink Tubing

Modified Polyvinylidene Fluoride; Shrink Ratio 2:1

Product description

3M™ Heat Shrink Tubing LMFP is a cross-linked, thin-walled, heat-shrinkable tubing offering a high degree of mechanical strength and high-temperature resistance. Fabricated from polyvinylidene fluoride, the tubing has outstanding abrasion resistance and cut-through properties in combination with high dielectric strength. It is inherently flame retardant, semi-rigid and highly resistant to most industrial fuels, chemicals and solvents. When heated in excess of 175°C (347°F), MFP tubing rapidly shrinks to a skintight fit. This tubing is rated for continuous operation from -55°C (-67°F) to 175°C (347°F).

Typical applications

MFP tubing is designed for shrink-fit protection and strain relief of wires, solder joints, terminals and connections. Suggested applications include automotive wiring, jackets, fuse coverings and military wire markers. Because the tubing is transparent, it allows see-through inspection and identification and is ideal for use as a jacketing for components such as resistors and capacitors. The tubing is readily marked by hot-stamp and print-wheel equipment.

Shrink ratio

MFP tubing has a 2:1 shrink ratio. When freely recovered, the tubing will shrink to 50% of its as-supplied internal diameter. The recovered wall thickness is proportional to the degree of recovery.

Standard color

Clear. Colors available subject to factory quotation.

Standard packaging

Four-foot lengths.

Ordering information

Order MFP tubing by product name, size equivalent to the expanded inside diameter, package type and color. Always order the largest size that will shrink snugly over the item to be covered.

Example: MFP tubing, 3/8", 4 ft., clear.

Standard Sizes and Dimensions

Ordering Size in.	Expanded I.D. (Minimum)		Recovered I.D. (Maximum)		Recovered Wall Thickness (Nominal)	
	in.	(mm)	in.	(mm)	in.	(mm)
3/64	.046	(1,17)	.023	(0,58)	.010	(0,25)
1/16	.063	(1,60)	.031	(0,79)	.010	(0,25)
3/32	.093	(2,36)	.046	(1,17)	.010	(0,25)
1/8	.125	(3,18)	.062	(1,57)	.010	(0,25)
3/16	.187	(4,75)	.093	(2,36)	.010	(0,25)
1/4	.250	(6,35)	.125	(3,18)	.012	(0,30)
3/8	.375	(9,53)	.187	(4,75)	.012	(0,30)
1/2	.500	(12,70)	.250	(6,35)	.012	(0,30)
5/8	.625	(15,88)	.313	(7,94)	.014	(0,36)
3/4	.750	(19,05)	.375	(9,53)	.017	(0,43)
1	1.000	(25,40)	.500	(12,70)	.019	(0,48)

Note: Dimensions in inches are approximate.

Typical Properties

Applicable Specification

SAE-AMS-DTL-23053/8*, Meets functional requirements of SAE-AMS-DTL-23053/18, Class 1; UL File E-39100, VW-1; CSA LR 38227, OFT**

Physical

Tensile Strength 5500 PSI
 Ultimate Elongation 350%
 Longitudinal Change +1, -10%
 Specific Gravity 1.7
 Operating Temperature Range -55°C to +175°C
 Shrink Temperature (Min.) 175°C (347°F)
 Low Temperature Flexibility (4 hrs. @ -55°C) No cracking
 Flammability Self-extinguish meets UL 224 VW-1 Test

Electrical

Dielectric Strength 900 V/mil
 Volume Resistivity 10¹⁴ ohm-cm

Chemical

Corrosion Resistance Non-corrosive
 Fuel & Oil Resistance Excellent
 Solvent Resistance Excellent
 Abrasion Resistance Excellent
 Acids & Alkalis Resistance Excellent

Secant Modulus (2%) 123,000PSI

Technical information provided consists of typical product data and should not be used for specification purposes. Unless otherwise noted, all tests are performed at room temperature.

* Formerly MIL+23053/8 and MIL-DTL-23053/8

** Formerly MIL+23053/18 and MIL-DTL-23053/18



Heat Shrink Tubing NST

Modified Chlorinated Polyolefin (Neoprene); Shrink Ratio 2:1

Product description

3M™ Heat Shrink Tubing NST provides excellent cut-through and abrasion resistance. It also is resistant to some solvents and fluids, including oil. The tubing maintains flexibility at low temperatures and can be readily marked by hot-stamp and print-wheel methods. When heated in excess of 135°C (275°F) NST tubing rapidly shrinks to a skintight fit. NST tubing is rated for continuous operation from -70°C (-94°F) to 121°C (250°F).

Typical applications

NST tubing is designed for applications requiring a tough, highly flexible covering. It is particularly useful for fabrication and repair of flexible harnesses and wire bundles and for covering hydraulic couplings. Its excellent mechanical properties and broad operating temperature range make it an ideal choice for jacketing cable harnesses and custom-made cables that must operate in severe environmental conditions.

Shrink ratio

NST tubing has a 2:1 shrink ratio. When freely recovered, the tubing will shrink to 50% of its as-supplied internal diameter. The recovered wall thickness is proportional to the degree of recovery.

Standard color

Black.

Standard packaging

Spools.

Ordering information

Order NST tubing by product name, size equivalent to the expanded inside diameter, package type and color. Always order the largest size that will shrink snugly over the component to be covered. When ordering NST tubing, please indicate the applicable specification required. *Example: NST tubing, 3/16", spools, black.*

Standard Sizes and Dimensions

Ordering Size in.	Expanded I.D. (Minimum)		Recovered I.D. (Maximum)		Recovered Wall Thickness (Nominal)	
	in.	(mm)	in.	(mm)	in.	(mm)
1/8	.125	(3,18)	.062	(1,83)	.030	(0,76)
3/16	.187	(4,75)	.093	(2,69)	.035	(0,89)
1/4	.250	(6,35)	.125	(3,18)	.035	(0,89)
3/8	.375	(9,53)	.187	(4,75)	.040	(1,02)
1/2	.500	(12,70)	.250	(6,35)	.048	(1,22)
5/8	.625	(15,88)	.312	(7,92)	.052	(1,32)
3/4	.750	(19,05)	.375	(6,99)	.057	(1,45)
7/8	.875	(22,23)	.437	(11,10)	.065	(1,65)
1	1.000	(25,40)	.500	(12,70)	.070	(1,78)
1-1/4	1.250	(31,75)	.625	(15,54)	.087	(2,21)
1-1/2	1.500	(38,10)	.750	(19,05)	.095	(2,41)
1-3/4	1.750	(44,45)	.875	(22,23)	.107	(2,72)
2	2.000	(50,80)	1.000	(25,40)	.110	(2,79)
3	3.000	(75,20)	1.500	(38,10)	.125	(3,18)

Note: Dimensions in inches are approximate.

Typical Properties

Applicable Specification

SAE-AMS-DTL-23053/1*, Class 1, 2; UL File E-39100; CSA LR38227; SC-X-15112.

Physical

Tensile Strength 2100 PSI
 Ultimate Elongation 500%
 Longitudinal Change +1, -10%
 Specific Gravity 1.3
 Operating Temperature -70°C to +121°C
 Shrink Temperature 135°C (275°F)
 Low Temperature Flexibility (4 hrs. @ -70°C) No cracking
 Flammability Self-extinguish

Electrical

Dielectric Strength 800 V/mil
 Volume Resistivity 10¹² ohm-cm

Chemical

Corrosion Resistance Non-corrosive
 Fuel & Oil Resistance Excellent
 Solvent Resistance Good
 Abrasion Resistance Excellent
 Acids & Alkalis Resistance Excellent

Technical information provided consists of typical product data and should not be used for specification purposes. Unless otherwise noted, all tests are performed at room temperature.

* Formerly MIL+23053/1 and MIL-DTL-23053/1



Heat Shrink Tubing VTN-200

Modified Fluoroelastomer; Shrink Ratio 2:1

Product description

3M™ Heat Shrink Tubing VTN-200 is highly abrasive and cut-through resistant and can withstand a wide variety of fuels, lubricants, acids and highly corrosive fluids at high operating temperatures. In addition to its high continuous operating temperature and chemical-resistance properties, this tubing is very flexible and is easily marked by hot-stamp or print-wheel methods. When heated in excess of 175°C (347°F), VTN-200 tubing rapidly shrinks to a skintight fit. VTN-200 tubing is rated for continuous operation from -55°C (-67°F) to 200°C (392°F).

Typical applications

Because of its outstanding high-temperature fluid performance, VTN-200 tubing is often used to protect wiring and component covers in aircraft/aerospace applications including electronic control systems and hydraulic fluid transport mechanisms and in chemical plants.

Shrink ratio

VTN-200 tubing has a 2:1 shrink ratio. When freely recovered, the tubing will shrink to 50% of its as-supplied internal diameter. The recovered wall thickness is proportional to the degree of recovery.

Standard color

Black.

Standard packaging

Spools.

Ordering information

Order VTN-200 tubing by product name, size equivalent to the expanded inside diameter, package type and color. Always order the largest size that will shrink snugly over the component to be covered. *Example: VTN-200 tubing, 3/16," black, spools.*

Standard Sizes and Dimensions

Ordering Size in.	Expanded I.D. (Minimum)		Recovered I.D. (Maximum)		Recovered Wall Thickness (Nominal)	
	in.	(mm)	in.	(mm)	in.	(mm)
1/8	.125	(3,18)	.062	(1,57)	.030	(0,76)
3/16	.187	(4,75)	.093	(2,36)	.035	(0,89)
1/4	.250	(6,35)	.125	(3,18)	.035	(0,89)
3/8	.375	(9,53)	.187	(4,75)	.035	(0,89)
1/2	.500	(12,70)	.250	(6,35)	.035	(0,89)
5/8	.625	(15,88)	.312	(7,92)	.042	(1,07)
3/4	.750	(19,05)	.375	(9,53)	.042	(1,07)
7/8	.875	(22,23)	.438	(11,11)	.049	(1,24)
1	1.000	(25,40)	.500	(12,70)	.049	(1,24)
1-1/4	1.250	(31,75)	.625	(15,88)	.055	(1,40)
1-1/2	1.500	(38,10)	.750	(19,05)	.055	(1,40)
2	2.000	(50,80)	1.000	(25,40)	.065	(1,65)

Note: Dimensions in inches are approximate.

Typical Properties

Applicable Specification SAE-AMS-DTL-23053/13*

Physical

Tensile Strength 2400 PSI
 Ultimate Elongation 450%
 Longitudinal Change +1, -10%
 Specific Gravity 1.7
 Operating Temperature -55°C to +200°C
 Range
 Shrink Temperature 175°C (Min.) (347°F)
 Low Temperature Flexibility (4 hrs. @ -55°C) No cracking
 Flammability Self-extinguish

Electrical

Dielectric Strength 500 V/mil
 Volume Resistivity 10¹² ohm-cm

Chemical

Corrosion Resistance Non-corrosive
 Fuel & Oil Resistance Excellent
 Solvent Resistance Excellent
 Abrasion Resistance Excellent
 Acids & Alkalis Resistance Excellent

Technical information provided consists of typical product data and should not be used for specification purposes. Unless otherwise noted, all tests are performed at room temperature.

* Formerly MIL+23053/13 and MIL-DTL-23053/13



Heat Shrink Tubing PSTH

Flexible Elastomeric Polyester; Shrink Ratio 2:1

Product description

3M™ Heat Shrink Tubing PSTH is a high performance, rugged heat shrinkable tubing designed for harsh operating conditions. The tubing is made from flexible elastomeric polyester and has a continuous operating temperature range of -55°C (-70°F) to 150°C (302°F). PSTH tubing is resistant to a wide range of solvents and chemicals including aviation fuel, diesel fuel, lubricating oils and hydraulic fluid. 3M PSTH tubing is specifically designed to pass the SC-X15111C military specification but also meets the functional requirements of AMS-DTL-23053/16*.

Typical applications

PSTH tubing was developed for wire harness applications on military ground vehicles and is well suited for applications where conditions call for a high-performance heat shrink tubing, particularly where the tubing will be exposed to petroleum based fluids. PSTH is also an excellent choice for heavy duty equipment and off-road vehicles.

Shrink ratio

PSTH tubing has a 2:1 shrink ratio. When freely recovered, the tubing will shrink to 50% of its as-supplied internal diameter. The recovered wall thickness is proportional to the degree of recovery.

Standard color

Black.

Standard packaging

Spools.

Ordering Information

Order PSTH tubing by product name, size equivalent to the expanded inside diameter, package type and color. Always order the largest size that will shrink snugly over the component to be covered. *Example: PSTH tubing, 3/8", black, spools.*

Standard Sizes and Dimensions

Ordering Size in.	Expanded I.D. (Minimum)		Recovered I.D. (Maximum)		Recovered Wall Thickness (Nominal)	
	in.	(mm)	in.	(mm)	in.	(mm)
3/16	.187	(4,75)	.093	(2,36)	.035	(0,89)
1/4	.250	(6,35)	.125	(3,18)	.035	(0,89)
3/8	.375	(9,53)	.187	(4,75)	.035	(0,89)
1/2	.500	(12,70)	.250	(6,35)	.035	(0,89)
5/8	.625	(15,88)	.312	(7,92)	.042	(1,07)
3/4	.750	(19,05)	.250	(6,35)	.042	(1,07)
7/8	.875	(22,23)	.437	(11,10)	.045	(1,14)
1	1.000	(25,40)	.500	(12,70)	.049	(1,24)
1-1/4	1.250	(31,75)	.625	(15,88)	.055	(1,40)
1-1/2	1.500	(38,10)	.750	(19,05)	.055	(1,40)
2	2.000	(50,80)	1.000	(25,40)	.065	(1,65)

Note: Dimensions in inches are approximate.

Typical Properties

Applicable Specification

SC-X15111C (Military Spec)
 Meets the functional requirements of
SAE-AMS-DTL-23053/16*

Physical

Tensile Strength 2200 PSI
 Ultimate Elongation 350%
 Longitudinal Change +2, -8%
 Specific Gravity 1.6
 Operating Temperature -55°C to
 Range +150°C
 Shrink Temperature 170°C
 (Min.) (338°F)
 Low Temperature Flexibility
 (4 hrs. @ -55°C) No cracking
 Flammability Self-extinguish

Electrical

Dielectric Strength 500 V/mil
 Volume
 Resistivity 7x10¹⁴ ohm-cm

Chemical

Corrosion Resistance Non-corrosive
 Fuel & Oil Resistance Excellent
 Solvent Resistance Excellent
 Abrasion Resistance Excellent
 Acids & Alkalis Resistance Excellent

Technical information provided consists of typical product data and should not be used for specification purposes. Unless otherwise noted, all tests are performed at room temperature.

* Formerly MIL+23053/16 and MIL-DTL-23053/16

3M™ Heavy-Duty Tubing

- Abrasion and tear resistant
- Adhesive lined for environmental sealing
- Chemical and solvent resistant
- Flame retardant
- UV resistant

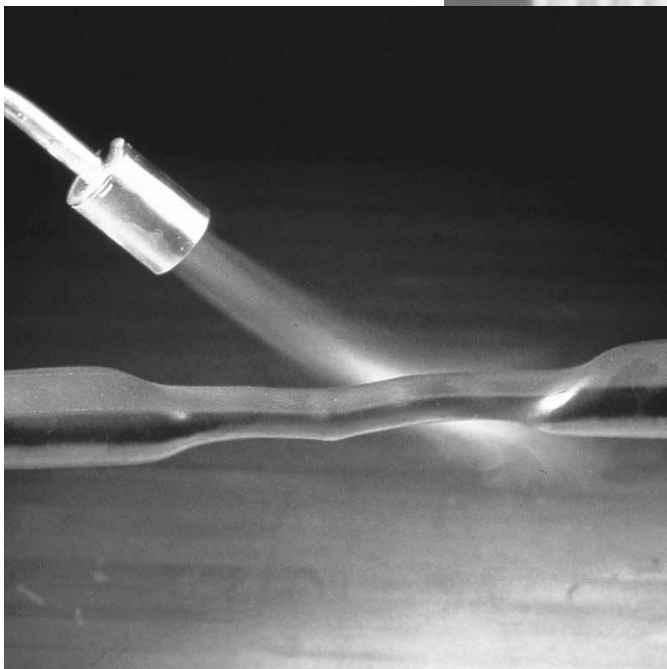



Heat Shrink Tubing MDT

Medium-Duty, Polyolefin

Product description

3M™ Heat Shrink Tubing MDT can offer increased flexibility in combination with excellent abrasion, corrosion and environmental resistance properties and data meets AMS-DTL-23053/15*, Class 2.

Uncoated product (without sealant) is available on special order. MDT medium-duty tubing is designed to provide reliable performance as well as excellent mechanical and environmental protection. These flame-retardant products combine the important advantages of easy handling and installation with maximum operating reliability and system protection. MDT tubing comes with a factory-applied sealant. This sealant is a heat-activated thermoplastic material that remains soft and flexible over long

periods under adverse environmental conditions. During heating the sealant softens, bonds to underlying surfaces and fills small voids that might be present. When cool, the sealant forms a barrier against water, moisture, dirt and other environmental contaminants.

Typical applications

MDT tubing installs easily and has shrink ratios to accommodate effective insulating and sealing over large transitions, splices and battery cables.

Standard color

All sizes available in black. MDT-0400, -0800 and -1100 tubing are also available in red.

Standard packaging

Four-foot lengths. Other lengths are available subject to special quotation.

Ordering information

Order MDT tubing by product name, size equivalent to the expanded inside diameter, package type and color. Always order the largest size that will shrink snugly over the component to be covered. *Example: MDT-1100-48A tubing, 4 ft., black.*

Typical Properties

Applicable Specification – SAE-AMS-DTL-23053/15,** Class 2; ABS			
Physical		(4 hrs. @ 225°C)	cracking, flowing
Tensile Strength	2400 PSI	*Low Temperature Flexibility	No cracking
Ultimate Elongation	475%	(4 hrs. @ -55°C)	
Longitudinal Change	+1, -10%	Flammability	Self-extinguish
Secant Modulus	14,000 PSI	Electrical	
Specific Gravity	1.28	Dielectric Strength	500 V/mil (60 mils)
*Heat Aging	7 days @ 175°C	Volume Resistivity	10 ¹⁴ ohm-cm
	Elongation 225%		
*Heat Shock	No dripping,	Technical information provided consists of typical product data and should not be used for specification purposes. Unless otherwise noted, all tests are performed at room temperature.	

* Outer wall only.

* Formerly MIL+23053/15 and MIL-DTL-23053/15

Standard Sizes and Dimensions (without adhesive)

Part Number	Cable Range	Expanded I.D.		Recovered I.D.		Recovered Outer Wall Thickness		Length in.	Std. Pkg. Pieces/ Carton	Color
		in.	(mm)	in.	(mm)	in.	(mm)			
MDT-0400-48A	#12 - #6 AWG	.40	(10,2)	.15	(3,8)	.09	(2,3)	48	20	Red and Black
MDT-0800-48A	#8 - #3 AWG	.80	(20,3)	.22	(5,6)	.10	(2,5)	48	20	Red and Black
MDT-1100-48A	#2 - 2/0 AWG	1.10	(27,9)	.37	(9,4)	.10	(2,5)	48	20	Red and Black
MDT-1300-48A	#1 - 4/0 AWG	1.30	(33,0)	.43	(10,9)	.10	(2,5)	48	15	Black Only
MDT-1500-48A	1/0 - 250 MCM	1.50	(38,1)	.50	(12,7)	.10	(2,5)	48	20	Black Only
MDT-1700-48A	4/0 - 400 MCM	1.70	(43,2)	.60	(15,2)	.10	(2,5)	48	20	Black Only
MDT-2000-48A	300 - 500 MCM	2.00	(50,8)	.75	(19,1)	.10	(2,5)	48	15	Black Only
MDT-3000-48A	600 - 1250 MCM	3.00	(76,2)	1.00	(25,4)	.12	(3,0)	48	15	Black Only
MDT-4300-48A	1000 - 2500 MCM	4.30	(109,2)	1.50	(38,1)	.15	(3,8)	48	10	Black Only



Heat Shrink Tubing HDT

Heavy-Duty, Polyolefin

Product description

3M™ Heat Shrink Tubing HDT is designed to provide reliable performance as well as excellent mechanical and environmental protection. This flame-retardant product combines the important advantage of easy handling and installation with maximum operating reliability and system protection. HDT tubing comes with a factory-applied sealant. This sealant is a heat-activated thermoplastic material that remains soft and flexible over long periods under adverse environmental conditions. During heating the sealant softens, bonds to underlying surfaces and fills small voids that might be present. When cool, the sealant forms a barrier against water, moisture, dirt and other environmental contaminants.

Heavy-duty tubing is fabricated from specially formulated cross-linked polyolefin, providing long-term environmental protection. The tubing is also highly chemical, abrasion and split resistant. Meets AMS-DTL-23053/15**, Class 1.

Uncoated product (without sealant) is available on special order.

Standard color

All sizes available in black. HDT-0300, -0400, -0800 and -1100 tubing are also available in red.

Standard packaging

Four-foot lengths. Other lengths are available subject to special quotation.

Ordering information

Order HDT tubing by product name, size equivalent to the expanded inside diameter, package type and color. Always order the largest size that will shrink snugly over the component to be covered. *Example: HDT-1100-48A tubing, 4 ft., black.*

Typical Properties

Applicable Specification – SAE-AMS-DTL-23053/15**, Class 1; ABS			
Physical		*Low Temperature Flexibility	No cracking
Tensile Strength	2400 PSI	(4 hrs. @ -55°C)	
Ultimate Elongation	475%	Flammability	Self-extinguish
Longitudinal Change	+1, -10%	Chemical	
Secant Modulus	14,000 PSI	Corrosion Effect	
Specific Gravity	1.28	Solvent Resistance	
*Heat Aging	7 days @ 175°C	Tensile Strength	
	Elongation 225%	Dielectric Strength	
*Heat Shock	No dripping,	Dielectric Strength	1500 PSI
(4 hrs. @ 225°C)	cracking, flowing	Volume Resistivity	200 V/mil
			Water Absorption
			0.02%
			Fungus Resistance
			Non-nutrient
Technical information provided consists of typical product data and should not be used for specification purposes. Unless otherwise noted, all tests are performed at room temperature.			

* Outer wall only.

* Formerly MIL+23053/15 and MIL-DTL-23053/15

Standard Sizes and Dimensions (without adhesive)

Part Number	Cable Range	Expanded I.D.		Recovered I.D.		Recovered Outer Wall Thickness		Length in.	Std. Pkg. Pieces/ Carton	Color
		in.	(mm)	in.	(mm)	in.	(mm)			
HDT-0300-48A	#14-#8 AWG	.30	(7,62)	.10	(2,5)	.08	(2,0)	48	20	Red and Black
HDT-0400-48A	#12 - #6 AWG	.40	(10,2)	.15	(3,8)	.09	(2,3)	48	20	Red and Black
HDT-0800-48A	#8 - 1/0 AWG	.80	(20,3)	.20	(5,1)	.11	(2,8)	48	20	Red and Black
HDT-1100-48A	#2 - 4/0 AWG	1.10	(27,9)	.37	(9,4)	.12	(3,0)	48	20	Red and Black
HDT-1500-48A	3/0 - 400 MCM	1.50	(38,1)	.50	(12,7)	.17	(4,3)	48	20	Black Only
HDT-2000-48A	250 - 750 MCM	2.00	(50,8)	.65	(16,5)	.17	(4,3)	48	10	Black Only
HDT-3000-48A	600 - 1250 MCM	3.00	(76,2)	1.00	(25,4)	.17	(4,3)	48	10	Black Only
HDT-4500-48A	1500 - 2500 MCM	4.50	(114,3)	1.50	(38,1)	.17	(4,3)	48	5	Black Only
HDT-6000-48A	2.1" - 4.8" O. D.	6.00	(152,4)	1.80	(45,7)	.17	(4,3)	48	5	Black Only
HDT-7000-48A	2.5" - 5.6" O. D.	7.00	(177,8)	2.00	(50,8)	.17	(4,3)	48	5	Black Only



Heat-Shrinkable Tubing for Bus Bar BBI-A Series

Tubing for Bus Bar Series 5–35 kV

Product Description

3M™ Heat Shrink Tubing for Bus Bar BBI-A Series is designed for insulating rectangular, square, and round bus bar rated from 5 kV through 35 kV. It will also cover and insulate inline bolted connections of rectangular bus bars.

The tubing meets the requirements of ANSI/IEEE Standard C37.20. The standard tubing lengths are 20 ft. (6,1 m) and 50 ft. (15,2 m).

BBI-A tubing is made of a specially formulated cross-linked polyolefin. The tubing is colored orange-red. The material has high resistance to splitting, good solvent resistance and excellent tracking resistance properties. The tubing shrinks easily with industry-standard methods, forming an aesthetically appealing insulation cover.

Durable

3M BBI-A tubing is made of specially formulated, cross-linked, flame retardant, track resistant polyolefin. This material has a high resistance to splitting, while providing the flexibility to conform to bends in certain applications. Excellent split resistance may prevent insulation failures and resulting downtimes.

Reliable

Heat shrinkable bus bar tubing is unaffected by normal cleaning fluids and is resistant to physical damage and high temperatures.

Excellent dielectric strength allows the required space between bus bars and metal enclosures to be substantially reduced. Closer spacing reduces both the overall size of the assembly, and the overall cost.

Cost effective

BBI-A tubing will shrink to fit rectangular, square or round bus bars and will handle voltage ranges from 600 volts to 35 kV. This can help reduce your inventory requirements.

Ordering Information

All sizes are available in 20 ft. (6,1 m) and 50 ft. (15,2 m) rolls, one per box. Order by product number and length. See chart for correct sizing.

Typical Properties

Applicable Specification

ASTM-D-257, 149, 150, 2303; IEC 216; ANSI/IEEE Standard C37.20

Physical

Tensile Strength	2200 PSI
Ultimate Elongation	575%
Water Absorption	
7 days @ 23°C (73°F)	0.3%
Corrosion (Copper)	
16 hrs. @ 120°C (248°F)	Pass

Electrical

Dielectric Strength	550 V/mil
Volume Resistivity	10 ¹³ ohm-cm
Track Resistance	2.5 kV

Thermal



Thermal Endurance	110°C (230°F)
Accelerated Aging	
Tensile	1430 PSI
Elongation	400%
Heat Shock	
4 hrs. @ 225°C (437°F)	Pass
Low Temp. Flexibility	Pass
4 hrs. @ -55°C (-67°F)	

Technical information provided consists of typical product data and should not be used for specification purposes. Unless otherwise noted, all tests are performed at room temperature.

Standard Sizes and Dimensions

Product Number	Lengths ft. (m)	Expanded I.D. (Minimum)		Recovered I.D. (Maximum)		Expanded Wall Thickness		Recovered Outer Wall Thickness	
		in.	(mm)	in.	(mm)	in.	(mm)	in.	(mm)
BBI-3A	20 (6,1) 50 (15,2)	2.38	(60,0)	1.01	(26,0)	.049	(1,24)	.113	(2,87)
BBI-4A	20 (6,1) 50 (15,2)	4.35	(110,0)	1.67	(42,0)	.043	(1,09)	.113	(2,87)
BBI-5A	20 (6,1) 50 (15,2)	5.30	(135,0)	2.04	(52,0)	.043	(1,09)	.114	(2,90)
BBI-6A	20 (6,1) 50 (15,2)	5.90	(150,0)	2.33	(59,0)	.046	(1,17)	.117	(2,97)
BBI-7A	20 (6,1) 50 (15,2)	6.78	(172,0)	2.55	(65,0)	.048	(1,22)	.130	(3,30)
BBI-8A	20 (6,1) 50 (15,2)	8.25	(210,0)	3.18	(81,0)	.049	(1,24)	.128	(3,25)
BBI-9A	20 (6,1) 50 (15,2)	8.83	(224,0)	3.78	(96,0)	.054	(1,37)	.127	(3,23)
BBI-10A	20 (6,1) 50 (15,2)	10.28	(261,0)	4.53	(115,0)	.059	(1,50)	.138	(3,51)

Bus Bar Size Ranges

Product Number	Outside Dimension (Bar Circumference A)	 Rectangular*	 Square*	 Round
5.8 & 15 kV Bus Bar Size Ranges				
BBI-3A	3.28 – 5.57 in. (83 – 141 mm)	1-1/2 x 1/4 – 2-1/2 x 1/2 in. (38x6 – 64x13 mm)	1 x 1 – 1-1/2 x 1-1/2 in. (25x25 – 38x38 mm)	1-1/8 – 1-3/4 in. (29 – 44 mm)
BBI-4A	5.43 – 8.86 in. (138 – 225 mm)	2-1/2 x 3/8 – 4 x 3/4 in. (64x10 – 102x19 mm)	2 x 2 in. (51 x 51 mm)	1-3/4 – 2-3/4 in. (44 – 70 mm)
BBI-5A	6.67 – 10.86 in. (169 – 276 mm)	3 x 5/8 – 5 x 3/4 in. (76x16 – 127x19 mm)	2 x 2 – 2-1/2 x 2-1/2 in. (51x51 – 64x64 mm)	2-1/8 – 3-3/8 in. (54 – 86 mm)
BBI-6A	7.57 – 12.86 in. (192 – 327 mm)	3-1/2 x 1/2 – 6 x 3/4 in. (89x13 – 152x19 mm)	2-1/2 x 2-1/2 – 3 x 3 in. (64x64 – 76x76 mm)	2-1/2 – 4 in. (64 – 102 mm)
BBI-7A	8.28 – 13.00 in. (210 – 330 mm)	4 x 1/4 – 6 x 3/4 in. (102x6 – 152x19 mm)	2-1/2 x 2-1/2 – 3 x 3 in. (64x64 – 76x76 mm)	2-3/4 – 4-1/8 in. (70 – 105 mm)
BBI-8A	10.29 – 16.43 in. (261 – 417 mm)	5 x 1/4 – 8 x 3/8 in. (127x6 – 203x10 mm)	3 x 3 – 4 x 4 in. (76x76 – 102x102 mm)	3-3/8 – 5-1/8 in. (86 – 130 mm)
BBI-9A	12.29 – 19.23 in. (312 – 488 mm)	6 x 1/4 – 9 x 3/4 in. (152x6 – 229x19 mm)	3-1/2 x 3-1/2 – 5 x 5 in. (89x89 – 127x127 mm)	4 – 6-1/8 in. (102 – 156 mm)
BBI-10A	15.43 – 24.14 in. (392 – 613 mm)	8 x 1/4 – 10 x 3/4 in. (203x6 – 254x19 mm)	5 x 5 – 6 x 6 in. (127x127 – 152x152 mm)	5 – 7-5/8 in. (127 – 194 mm)
25 kV Bus Bar Size Ranges				
BBI-3A	3.28 – 3.56 in. (83 – 90 mm)	1 1/2 x 1/4 – 1 1/2 x 3/8 in. (38x6 – 38x10 mm)	Measure Circumference	1-1/8 in. (29 mm)
BBI-4A	5.43 – 5.80 in. (138 – 147 mm)	2 1/2 x 3/8 – 2 1/2 x 5/8 in. (64x10 – 64x16 mm)	Measure Circumference	1-3/4 in. (44 mm)
BBI-5A	6.67 – 7.18 in. (169 – 182 mm)	3 x 5/8 – 3 x 3/4 in. (76x16 – 76x19 mm)	Measure Circumference	2-1/8 – 2-1/4 in. (54 – 57 mm)
BBI-6A	7.57 – 8.43 in. (192 – 214 mm)	3 1/2 x 1/2 – 4 x 1/4 in. (89x13 – 102x6 mm)	Measure Circumference	2-1/2 – 2-5/8 in. (64 – 67 mm)
BBI-7A	8.28 – 10.44 in. (210 – 265 mm)	4 x 1/4 – 5 x 3/8 in. (102x6 – 127x10 mm)	2-1/2 x 2-1/2 in. (64x64 mm)	2-3/4 – 3-1/4 in. (70 – 83 mm)
BBI-8A	10.29 – 12.88 in. (261 – 327 mm)	5 x 1/4 – 6 x 3/4 in. (127x6 – 152x19 mm)	3 x 3 in. (76x76 mm)	3-1/8 – 4 in. (86 – 102 mm)
BBI-9A	12.29 – 15.31 in. (312 – 389 mm)	6 x 1/4 – 7 x 3/4 in. (152x6 – 178x19 mm)	3-1/2 x 3-1/2 – 4 x 4 in. (89x89 – 102x102 mm)	4 – 4-7/8 in. (102 – 124 mm)
BBI-10A	15.43 – 19.79 in. (392 – 503 mm)	8 x 1/4 – 9 x 3/4 in. (203x6 – 229x19 mm)	5 x 5 in. (127x127 mm)	5 – 6-1/4 in. (127 – 159 mm)
35 kV Bus Bar Size Ranges				
BBI-7A	8.28 – 8.86 in. (210 – 225 mm)	4 x 1/4 – 4 x 3/4 in. (102x6 – 102x19 mm)	Measure Circumference	2-3/4 in. (70 mm)
BBI-8A	10.29 – 10.94 in. (261 – 278 mm)	(5 x 1/4 – 5 x 3/4 in. (127x6 – 127x19 mm)	Measure Circumference	3-3/8 in. (86 mm)
BBI-9A	12.29 – 13.00 in. (312 – 330 mm)	6 x 1/4 – 6 x 3/4 in. (152x6 – 152x19 mm)	Measure Circumference	4 – 4-1/8 in. (102 – 105 mm)
BBI-10A	15.43 – 16.86 in. (392 – 428 mm)	8 x 1/4 – 8 x 3/4 in. (203x6 – 203x19 mm)	Measure Circumference	5 – 5-1/4 in. (127 – 133 mm)

* Note: Rectangular and square bar sizes are based on bars having radiused edges and corners.

3M™ Heat Shrinkable Molded Shapes

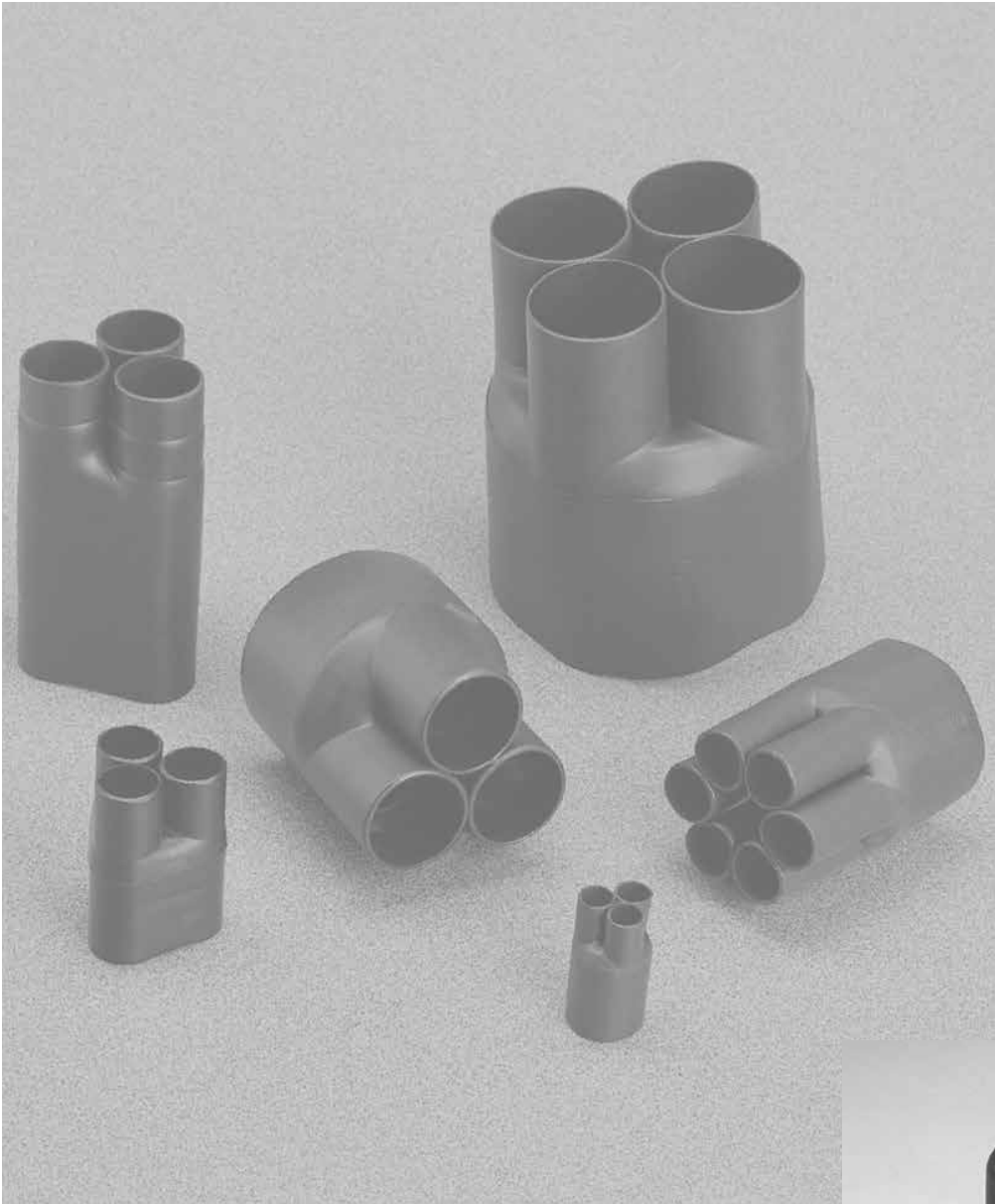

Heavy-Duty Breakout Boots:







- Strain relief and environmental and mechanical protection
- For breakouts in multiconductor armored or sheathed cables

Heavy-Duty End Caps:

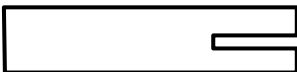
- Seal cable ends
- Provide environmental and mechanical protection
- Most can be fitted with air valves suitable for pressurized cable applications

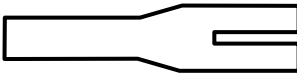

3M™ Heat Shrinkable Shapes Selection Guide

3M Part Series	Description	Style	Page
Heavy Duty Breakout Boots			
HDBB-205 to 230	Heavy Duty Breakout Boot, 2-Way Outlet		72
HDBB-310 to 345	Heavy Duty Breakout Boot, 3-Way Outlet		73
HDBB-405 to 430	Heavy Duty Breakout Boot, 4-Way Outlet		74
HDBB-505	Heavy Duty Breakout Boot, 5-Way Outlet		75
HDBB-605	Heavy Duty Breakout Boot, 6-Way Outlet		76
Cable End Caps			
SKE 4/10 to SKE 45/100	Heavy Duty End Caps		78



Heat Shrink Heavy Duty Breakout Boot HDBB-205 to 230

2-Way Outlet

Typical applications

These breakout boots provide strain relief and environmental/mechanical protection for breakouts in multiconductor armored or sheathed cables. This style is designed for two breakouts.

Expanded part (as supplied)

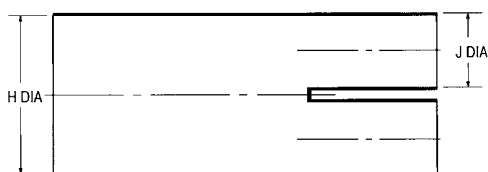

Fully recovered part (after heating)

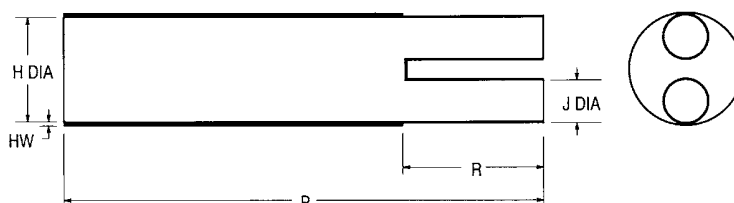

Standard Sizes and Dimensions

PART NUMBER	NAVSEA or DOD-STD-2003-1 Part Number	Cable End H DIA		Conductor Legs J DIA		P +10% R	R +10% R	HW +20% R
		MIN X	MAX R	MIN X	MAX R			
HDBB-205-1-250	1A62-1	0.80 (20.32)	0.37 (9.40)	0.33 (8.38)	0.11 (2.79)	2.70 (68.58)	0.70 (17.78)	0.06 (1.52)
HDBB-210-1-250	1A62-2	1.20 (30.48)	0.60 (15.24)	0.50 (12.70)	0.17 (4.32)	3.50 (88.90)	1.00 (25.40)	0.08 (2.03)
HDBB-220-1-250	1A62-3	1.90 (48.26)	0.90 (22.86)	0.75 (19.05)	0.30 (7.62)	4.20 (106.68)	1.20 (30.48)	0.12 (3.05)
HDBB-230-1-250	1A62-4	3.00 (76.20)	1.50 (38.10)	1.45 (36.83)	0.50 (12.70)	5.00 (127.00)	1.50 (38.10)	0.12 (3.05)

Notes:

- All dimensions in both inches and metric, all angles in degrees
- Dimension in table: X = Expanded (Minimum) R = Recovered (Maximum)
- Color: Black
- 3M CAGE Code: 75037

Materials Available	Standard Part Supplied with -250 Adhesive		
-1 Semi-rigid Flame Retardant Polyolefin†	Adhesive (Part #)	Factory Applied	Description
-3 Flexible Polyolefin, Halogen Free*	TTS-250	-250	Thermoplastic 80°C
-6 Flexible Flame Retardant Polyolefin*			

† Standard Product

* Price, minimum order quantity and lead will vary for these.



Heat Shrink Heavy Duty breakout Boot HDBB-310 to 345 3-Way Outlet

Typical applications

These breakout boots provide strain relief and environmental/mechanical protection for breakouts in multiconductor armored or sheathed cables. This style is designed for three breakouts.

Expanded part (as supplied)

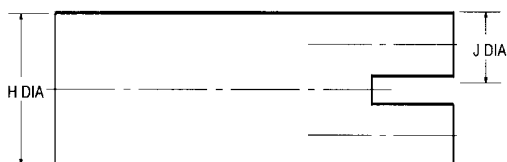

Fully recovered part (after heating)

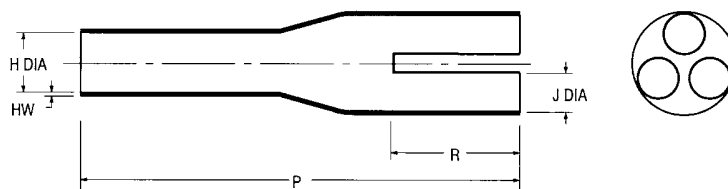

Standard Sizes and Dimensions

PART NUMBER	NAVSEA or DOD-STD-2003-1 Part Number	Cable End H DIA		Conductor Legs J DIA		P +10% R	R +10% R	HW +20% R
		MIN X	MAX R	MIN X	MAX R			
HDBB-310-1-250	1A62-5	0.90 (22.86)	0.36 (9.14)	0.33 (8.38)	0.12 (3.05)	2.70 (68.58)	0.70 (17.78)	0.10 (2.54)
HDBB-320-1-250	1A62-6	1.20 (30.48)	0.50 (12.70)	0.50 (12.70)	0.16 (4.06)	3.30 (83.82)	1.00 (25.40)	0.10 (2.54)
HDBB-321-1-250	1A62-7	1.50 (38.10)	0.69 (17.53)	0.65 (16.51)	0.18 (4.57)	4.00 (101.60)	2.20 (55.88)	0.90 (22.86)
HDBB-325-1-250	1A62-8	1.70 (43.18)	0.90 (22.86)	0.82 (20.83)	0.30 (7.62)	4.50 (114.30)	1.20 (30.48)	0.14 (3.56)
HDBB-335-1-250	1A62-9	2.40 (60.96)	1.40 (35.56)	1.25 (31.75)	0.50 (12.70)	5.10 (129.54)	1.60 (40.64)	0.15 (3.81)
HDBB-340-1-250	1A62-10	3.20 (81.28)	2.00 (50.80)	1.40 (35.56)	0.75 (19.05)	5.10 (129.54)	1.60 (40.64)	0.15 (3.81)
HDBB-345-1-250	1A62-11	4.90 (124.46)	2.32 (58.93)	2.00 (50.80)	1.00 (25.40)	10.00 (254.00)	2.50 (63.50)	0.13 (3.30)

Notes:

- All dimensions in both inches and metric, all angles in degrees
- Dimension in table: X = Expanded (Minimum) R = Recovered (Maximum)
- Color: Black
- 3M CAGE Code: 75037

Materials Available		Standard Part Supplied with -250 Adhesive		
-1	Semi-rigid Flame Retardant Polyolefin	Adhesive (Part #) TTS-250	Factory Applied -250	Description Thermoplastic 80°C
-3	Flexible Polyolefin, Halogen Free			
-6	Flexible Flame Retardant Polyolefin			



Heat Shrink Heavy Duty Breakout Boot HDBB-405 to 430

4-Way Outlet

Typical applications

These breakout boots provide strain relief and environmental/mechanical protection for breakouts in multiconductor armored or sheathed cables. This style is designed for four breakouts.

Expanded part (as supplied)

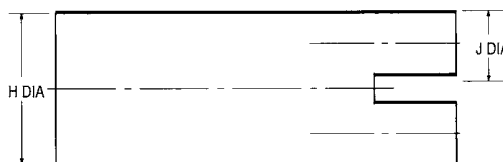

Fully recovered part (after heating)

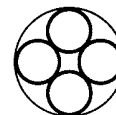
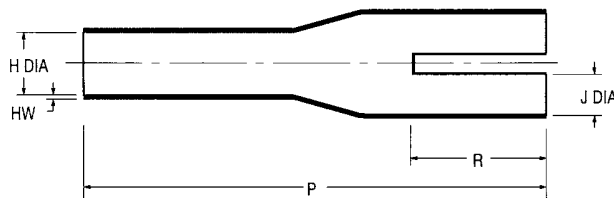

Standard Sizes and Dimensions

PART NUMBER	NAVSEA or DOD-STD-2003-1 Part Number	Cable End H DIA		Conductor Legs J DIA		P	R	HW
		MIN X	MAX R	MIN X	MAX R	+10% R	+10% R	+20% R
HDBB-405-1-250	1A62-12	0.90 (22.86)	0.43 (10.92)	0.28 (7.11)	0.11 (2.79)	2.75 (69.85)	0.75 (19.05)	0.05 (1.27)
HDBB-410-1-250	1A62-13	1.25 (31.75)	0.80 (20.32)	0.50 (12.70)	0.19 (4.83)	3.30 (83.82)	1.00 (25.40)	0.09 (2.29)
HDBB-415-1-250	1A62-14	1.75 (44.45)	0.98 (24.89)	0.79 (20.07)	0.28 (7.11)	3.50 (88.90)	1.20 (30.48)	0.15 (3.81)
HDBB-420-1-250	1A62-15	2.35 (59.69)	1.00 (25.40)	1.00 (25.40)	0.35 (8.89)	8.50 (215.90)	1.70 (43.18)	0.15 (3.81)
HDBB-425-1-250	1A62-16	2.65 (67.31)	1.40 (35.56)	1.20 (30.48)	0.53 (13.46)	5.00 (127.00)	1.50 (38.10)	0.15 (3.81)
HDBB-430-1-250	1A62-17	5.25 (133.35)	3.00 (76.20)	1.35 (34.29)	0.55 (13.97)	9.00 (228.60)	3.00 (76.20)	0.14 (3.56)

Notes:

- All dimensions in both inches and metric, all angles in degrees
- Dimension in table: X = Expanded (Minimum) R = Recovered (Maximum)
- Color: Black
- 3M CAGE Code: 75037

Materials Available		Standard Part Supplied with -250 Adhesive		
-1	Semi-rigid Flame Retardant Polyolefin	Adhesive (Part #) TTS-250	Factory Applied -250	Description Thermoplastic 80°C
-3	Flexible Polyolefin, Halogen Free			
-6	Flexible Flame Retardant Polyolefin			



Heat Shrink Heavy Duty Breakout Boot HDBB-505 5-Way Outlet

Typical applications

These breakout boots provide strain relief and environmental/mechanical protection for breakouts in multiconductor armored or sheathed cables. This style is designed for five breakouts.

Expanded part (as supplied)

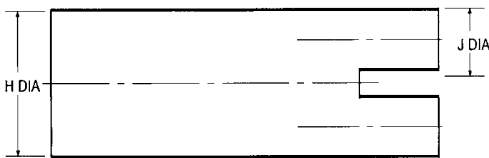

Fully recovered part (after heating)

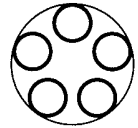
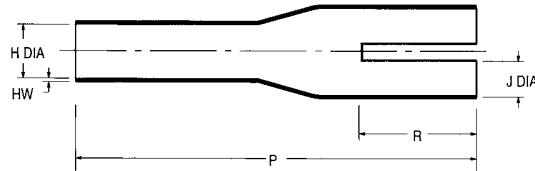

Standard Sizes and Dimensions

PART NUMBER	Cable End H DIA		Conductor Legs J DIA		P	R	HW
	MIN X	MAX R	MIN X	MAX R	+10% R	+10% R	+20% R
HDBB-505-1-250	2.36 (59.94)	0.96 (24.38)	1.18 (29.97)	0.29 (7.37)	7.08 (179.83)	1.18 (29.97)	0.14 (3.56)

Notes:

- All dimensions in both inches and metric, all angles in degrees
- Dimension in table: X = Expanded (Minimum) R = Recovered (Maximum)
- Color: Black
- 3M CAGE Code: 75037

Materials Available		Standard Part Supplied with -250 Adhesive		
		Adhesive (Part #)	Factory Applied	Description
-1	Semi-rigid Flame Retardant Polyolefin	TTS-250	-250	Thermoplastic 80°C
-3	Flexible Polyolefin, Halogen Free			
-6	Flexible Flame Retardant Polyolefin			



Heat Shrink Heavy Duty Breakout Boot HDBB-605

6-Way Outlet

Typical applications

These breakout boots provide strain relief and environmental/mechanical protection for breakouts in multiconductor armored or sheathed cables. This style is designed for six breakouts.

Expanded part (as supplied)

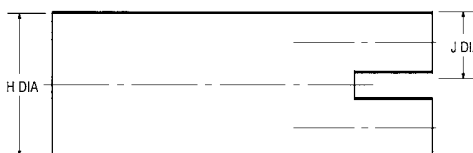

Fully recovered part (after heating)

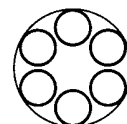
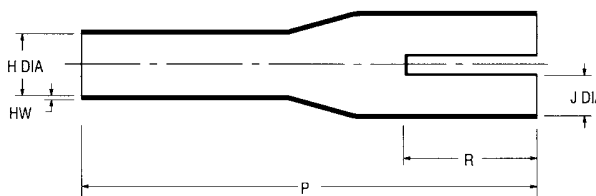

Standard Sizes and Dimensions

PART NUMBER	NAVSEA or DOD-STD-2003-1 Part Number	Cable End H DIA		Conductor Legs J DIA		P	R	HW
		MIN X	MAX R	MIN X	MAX R	+10% R	+10% R	+20% R
HDBB-605-1-250	1A62-18	2.39 (60.71)	1.45 (36.83)	0.80 (20.32)	0.35 (8.89)	5.40 (137.16)	2.00 (50.80)	0.10 (2.54)

Notes:

- All dimensions in both inches and metric, all angles in degrees
- Dimension in table: X = Expanded (Minimum) R = Recovered (Maximum)
- Color: Black
- 3M CAGE Code: 75037

Materials Available		Standard Part Supplied with -250 Adhesive		
		Adhesive (Part #)	Factory Applied	Description
-1	Semi-rigid Flame Retardant Polyolefin	TTS-250	-250	Thermoplastic 80°C
-3	Flexible Polyolefin, Halogen Free			
-6	Flexible Flame Retardant Polyolefin			



Heat Shrink Heavy Duty End Caps SKE 4/10 to SKE 45/100

Typical applications

Heat shrinkable end caps are typically used to seal cable ends and provide mechanical and environmental protection. With the exception of SKE 4/10, these end caps can be fitted with air valves suitable for pressurized cable applications. Consult factory.

Expanded part (as supplied)

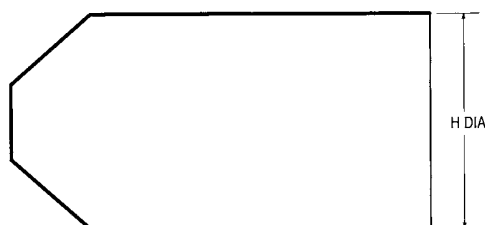

Fully recovered part (after heating)

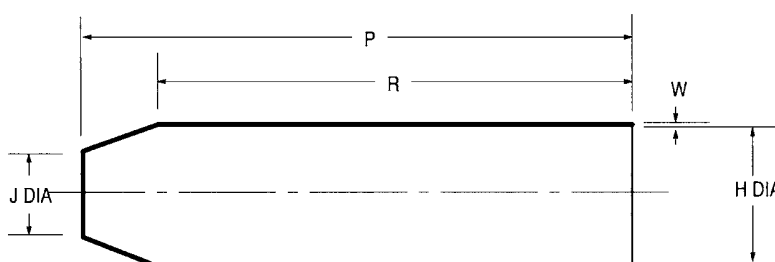

Standard Sizes and Dimensions

PART NUMBER	Cable End H DIA		J DIA MAX R	P +10% R	R +10% R	HW +20% R	For Cable Diameters
	MIN X	MAX R					
SKE 4/10	0.39 (9.91)	0.16 (4.06)	0.12 (3.05)	1.32 (33.53)	1.18 (29.97)	0.08 (2.03)	0.16 - 0.31 (4-8)
SKE 8/20	0.79 (20.07)	0.30 (7.62)	0.26 (6.60)	2.18 (55.37)	1.97 (50.04)	0.09 (2.29)	0.31 - 0.43 (8-16)
SKE 15/40	1.57 (39.88)	0.59 (14.99)	0.41 (10.41)	3.54 (89.92)	3.15 (80.01)	0.12 (3.05)	0.59-1.26 (15-32)
SKE 25/63	2.48 (62.99)	0.98 (24.89)	0.63 (16.00)	5.63 (143.00)	5.12 (130.05)	0.13 (3.30)	1 - 1.97 (25-50)
SKE 30/76	2.99 (75.95)	1.18 (29.97)	0.67 (17.02)	6.22 (157.99)	5.91 (150.11)	0.16 (4.06)	1.18 - 2.36 (30-60)
SKE 45/100	3.94 (100.08)	1.77 (44.96)	1.02 (25.91)	6.40 (162.56)	5.50 (139.70)	0.16 (4.06)	1.77 - 3.15 (45-80)

Notes:

- All dimensions in both inches and metric, all angles in degrees
- Dimension in table: X = Expanded (Minimum) R = Recovered (Maximum)
- Color: Black
- 3M CAGE Code: 75037

Materials Available		Standard Part Supplied with -250 Adhesive		
-1	Semi-rigid Flame Retardant Polyolefin	Adhesive (Part #)	Factory Applied	Description
-3	Flexible Polyolefin, Halogen Free	TTS-250	-250	Thermoplastic 80°C
-6	Flexible Flame Retardant Polyolefin			

3M™ Moisture Sealing Products



EMB/EMS:

- Self-fusing, rubber based mastic
- Flame retardant
- Solvent resistant



Electrical Moisture Block EMB

3M™ Electrical Moisture Block (EMB) is a specially formulated rubber adhesive/sealant for moisture proofing wire bundles.

- Resistant to salt water, corrosive chemicals and automotive fluids
- Flexible over a wide temperature range
- Easily installed
- Flame retardant

EMB moisture block is a self-fusing, rubber based insulating adhesive/sealant designed to prevent the migration of water along harness wiring. EMB moisture block is supplied on a release liner and offered in standard sizes to accommodate different size wire bundles. EMB moisture block is compatible with typical wire insulation such as PVC, synthetic rubber, and crosslinked polyethylene.

Performance Criteria

EMB moisture block is supplied on a release liner in three thicknesses. They are compatible with typical extruded wire insulations found in automotive and marine wiring. The product is not functionally affected by moisture, or automotive fluids, and withstands severe vibration and extreme temperature changes. Sealed wire harnesses have demonstrated effective moisture proofing in vehicles through-firewall applications. In addition, sealed harnesses withstand direct spray in 3M laboratory tests.

Installation Techniques

Remove cut piece from liner. Place among wires ensuring there is space between wires to allow room for sealant flow. Wires are best aligned vertically to accomplish this. Wrap around to other side of wire and press together (figure 1).

A second assembly can then be pressed into the original. Further wires are sealed in the same manner (figure 2).

After assembly, the sealant is pressed together and shaped by hand and then compressed with a mechanical tool. To complete the harness moisture block, tightly insulate with 3M heat shrink or cold shrink tubing or 3M vinyl tape (figure 3).

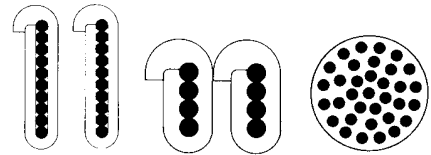

FIGURE 1

FIGURE 2

FIGURE 3

Storage

Under normal storage conditions (23°C, @ 50% RH), EMB moisture block will have a minimum two year shelf life when the material is stored in the original container.

Product Description

Part Number	Color	Pad Thickness	Pad Dimensions
EMB-45R	Black	.045"	0.75" x 100'
EMB60	Black	.060"	0.75" x 100'
EMB60R	Black	.060"	0.75" x 100'
EMB-75	Black	.075"	0.875" x 4"

100 foot rolls and other sizes available by special order.

Typical Properties

Property	Value*
Thickness of Sealant ¹	
EMB-45R	45 mils
EMB-60/EMB-60R	60 mils
EMB-75	75 mils
Adhesion to Steel ¹	12.5 lbs/in. width (22 N/10 mm)
Adhesion to Polyethylene ²	12.5 lbs/in width (22 N/10 mm)
Water Absorption ³	0.75%
Heat Resistance ⁴	130°C
Test Methods	
¹ ASTM-D1000-82a	
² ASTM-D1000-82a modified	
³ ASTM-D570-63	
⁴ Ford Performance Test ES-FOEB-1A263-AA	
*Not recommended for specification purposes. Product specifications will be provided upon request.	



Electrical Moisture Sealant Pads EMS II

Flame Retardant All-Weather Polyvinyl Chloride Backing with Thick Rubber Adhesive for Wiring Harnesses

- Encapsulates and seals under 600 volt connections
- Resistant to salt water, corrosive chemicals
- Easily installed
- Flexible over wide temperature range
- Resists vapors/splashes from automotive fluids
- Improved three-sided construction, mastic exposure eliminated

3M™ Electrical Moisture Sealant Pads EMS II-60 and EMS II-90, are self-fusing, rubber based insulating compounds laminated to a flexible, all-weather grade vinyl (PVC) backing. The pre-cut pads are designed to electrically insulate and moisture seal electrical junctions for automotive, trailer, truck, heavy equipment, marine or other outdoor wiring connections. These pads have excellent resistance to abrasion, moisture, ozone, alkalies, acids, copper corrosion and varying weathering conditions.

The seal materials are compatible with typical wire insulations, such as PVC, synthetic rubber, and cross-linked polyethylene.

These pads incorporate a vinyl backing overlap on three sides. This improvement eliminates exposed sealant when the pad is applied.

Performance criteria

The insulation is a composite of all-weather polyvinyl chloride (PVC) backing and a thick rubber-based pressure sensitive adhesive. EMS II electrical moisture sealant pads do not degrade when exposed to automotive and marine environments. They are compatible with typical extruded wire insulations found in automotive and marine wiring, and are not affected by severe vibration or extreme temperature changes. These products are not functionally affected by moisture, auto fluid splashes or vapors.

Installation techniques

Remove pad from liner. Place splice in center of pad with adhesive tape side parallel to wires and fold pad around splice such that adhesive surfaces come in contact. Press together. Place the newly insulated splice in the center of a compression tool with the pad seam up. Compress the pad with tool for four seconds. Finger pressure may be adequate for simpler splices. Remove splice.

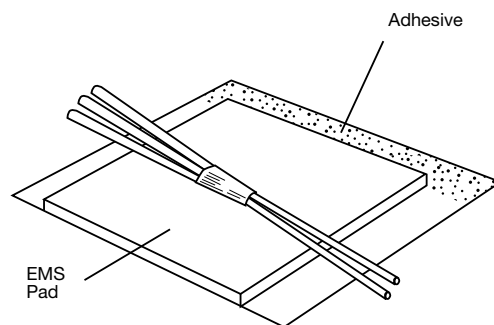

NOTE: Do not hold wires while compressing pad. Hydraulic pressure from compressed adhesive will flair the wires automatically causing the adhesive to flow between and seal the wires. Pressed pads may be reshaped to make the covered junction more compact.

Typical Performance Tests

Property	Conditions*
Current Leakage	<0.250 microamps
Heat Aging	130°C
Thermal Cycle	-40°C to 130°C
Vibration	24 hrs.
Auto Fluid Compatibility	10 fluids
Cold Flex	-18°C
Dielectric Withstand	1000 volts A.C.

* Not recommended for specification purposes. Product specifications will be provided upon request.

3M Test Methods available upon request. EMS II-60 and EMS II-90 moisture sealant pads meet UL flammability requirements.

Product Description

Part Number	Color	Pad Dimensions (Sealant only)	Overall Thickness with vinyl backing
EMS II-60	Gray	.060" x 1.5" x 1.5"	.067
EMS II-90	Brown	.090" x 1.5" x 1.5"	.097
EMS II-125	Black	.125" x 1.5" x 1.5"	.132

Sizing Guidelines for 3M™ Electrical Moisture Sealant Pads EMS II given AWG and Number of Wires*

Number of wires						
Wire AWG	1	2	3	4	5	6
22 AWG	EMS II-60	EMS II-60	EMS II-60	EMS II-60	EMS II-60	EMS II-90
20 AWG	EMS II-60	EMS II-60	EMS II-60	EMS II-60	EMS II-90	EMS II-90
18 AWG	EMS II-60	EMS II-60	EMS II-60	EMS II-90	EMS II-90	EMS II-125
16 AWG	EMS II-60	EMS II-60	EMS II-90	EMS II-90	EMS II-125	EMS II-125
14 AWG	EMS II-60	EMS II-90	EMS II-90	EMS II-125		
12 AWG	EMS II-60	EMS II-90	EMS II-125			
10 AWG	EMS II-60	EMS II-125				

Example: Splicing 3 x 16 AWG wires to 1 x 12 AWG wires

Step 1: 3 x 16 AWG wires requires an EMS II-90 pad.

Step 2: 1 x 12 AWG wires requires an EMS II-60 pad.

Therefore use the larger pad, the EMS II-90.

*Guidelines only - Customer must determine suitability for its own application.

Non-Flame Retardant Mastic Pads Available in Smaller Put-ups

3M Mastic Pad 2210 rolls (90 mil thickness) and 2200 pads (125 mil thickness) are made of a self-fusing, rubber-based insulating compound, laminated to an all-weather grade vinyl (PVC) backing. They mold easily around difficult shapes and will insulate, moisture-seal and pad all connections up to 600 volts.

Product Description

Part Number	Dimensions (Sealant only)	Quantity
2200	0.125" x 3.25" x 4.5" pads	10 pads/box; 5 bxs/ctn
2200	0.125" x 6.5" x 4.5" pads	10 pads/box; 5 bxs/ctn
2210	0.090" x 4.0" x 10' roll	1 roll/box; 10 rolls/ctn



3M™ Adhesives to Suit the Application

3M adhesives are an important part of wire harness assemblies where they provide environmental sealing between heat shrinkable components. 3M offers two adhesive options to suit a range of application and temperature requirements, while retaining compatibility with the various types of 3M molded shapes and tubings used in wire harnesses.

Thermoplastic Hot Melt Adhesives

A hot melt, thermoplastic adhesive, 3M™ Adhesive TTS-450 is supplied in strip or tape form for easy installation at the time of harness fabrication. It will melt and flow when heated, and upon cooling will set up to provide a firm, flexible environmental seal. The tape form permits placing the adhesive where it is required to seal between the shape and tubing prior to shrinking the shape.

The heat applied to shrink the shape will also melt and flow the adhesive in place at the same time. Thermoplastic adhesives, such as TTS-450 adhesive, can be remelted if reheated above their melt temperature to facilitate component repair or repositioning.

Two-Part Epoxy Adhesive

TPA-150 adhesive is a two-part, epoxy adhesive system adhesive with cure conditions ranging from 24 hours at room temperature to only 30 minutes at 150°C. TPA-150 adhesive is a high temperature adhesive which maintains bond integrity from -55°C to 150°C. It is normally used in high temperature systems, such as with the special purpose elastomeric tubing and shapes.

TPA-150 adhesive is packaged in cartridges for use with a 3M Scotch-

Weld™ Applicator EPX. This application system simultaneously meters and mixes the adhesives as it is applied, eliminating waste and the need for separate mixing equipment.

The following tables show typical properties and compatibility with shapes and tubing for these adhesives.

Adhesives

3M™ Adhesives for Heat Shrinkable Molded Shapes Compatibility with Shapes and Tubings

3M Adhesive Part Number	Description	Available Form	Factory Preapplied Designation	Operating Temperature	Compatible With
TPA-150, or TPA 150M	2-Part Thermoset cross linkable Epoxy	1.67 oz. Cartridge with Applicator	–	-55°C to 150°C	Polyolefin, NST VTN-200, PST-H, Kynar
TTS-450	Thermoplastic Hot Melt, re-enterable	Tape 100' x 1" x .010"	-450	-55°C to 120°C	Polyolefin, NST



Cold Shrink Connector Insulators



These open-ended, tubular rubber sleeves are designed for protecting and insulating solid dielectric insulated wire and cable but also provide excellent strain relief and physical protection for wire harnesses.

They are factory expanded and assembled onto a core which is removed after the tube has been positioned for installation over an inline connection or harness section. The tube shrinks, forming a dynamic, environmental seal which resists prolonged aging and exposure. It installs quickly with little training and no tools or heat source.

The 8420 series insulators are made of EPDM rubber. Six diameter sizes may cover a range of 1000-volt cable to 10 AWG through 1000 kcmil.

The 8440 series insulators are made of silicone rubber and come in three sizes which may cover an application range of 6 AWG to 3/0 AWG.

Product Series	UPC	Typical Conductor Size	Min. Cable Diameter for Seal	Max.** Diam. Insulator Covers	Max. Connector Length	Relaxed Tube Length	Inner Unit Pack	Case Qty.
Single Conductor Cable								
See above for cable type illustration.								
8423-6	054007-42146	6-4 AWG (14-16 mm ²)	0.31" (7,8 mm)	0.56" (4,3 mm)	2.0" (50,8 mm)	6.0" (152,4 mm)	10 each	10 each per case
8423-6P	054007-42864	6-4 AWG	0.31" (7,8 mm)	0.56" (4,3 mm)	2.0" (50,8 mm)	6.0" (152,4 mm)	10 each	10 each per case
8424-8	054007-42390	10-1/0 AWG (6-16 mm ²)	0.10" (2,5 mm)	0.82" (20,9 mm)	3.0" (76,2 mm)	8.0" (203,2 mm)	10 each	10 each per case
8424-8P	054007-42865	1-1/0 AWG	0.10" (2,5 mm)	0.82" (20,9 mm)	3.0" (76,2 mm)	8.0" (203,2 mm)	10 each	10 each per case
8425-8	054007-42391	2-1/0 AWG (35-50 mm ²)	0.40" (10,1 mm)	0.82" (20,9 mm)	3.0" (76,2 mm)	8.0" (203,2 mm)	10 each	10 each per case
8425-8P	054007-42866	2-1/0 AWG	0.40" (10,1 mm)	0.82" (20,9 mm)	3.0" (76,2 mm)	8.0" (203,2 mm)	10 each	10 each per case
8426-9	054007-34457	2/0 AWG-250 kcmil (70-125 mm ²)	0.55" (13,9 mm)	1.18" (30,1 mm)	5.0" (127,0 mm)	9.0" (228,6 mm)	10 each	10 each per case
8426-9M	054007-43436	2-4/0 AWG (30-90 mm ²)	0.40" (10,1 mm)	1.18" (30,1 mm)	5.0" (127,0 mm)	9.0" (228,6 mm)	10 each	10 each per case
8426-9P	054007-42867	2/0 AWG-250 kcmil	0.55" (13,9 mm)	1.18" (30,1 mm)	5.0" (127,0 mm)	9.0" (228,6 mm)	10 each	10 each per case
8426-11	054007-34458	2/0 AWG-250 kcmil (70-125 mm ²)	0.55" (13,9 mm)	1.18" (30,1 mm)	7.0" (177,8 mm)	11.0" (279,4 mm)	10 each	10 each per case
8427-6	054007-09915	-	0.69" (17,5 mm)	1.38" (35,1 mm)	2.0" (50,8 mm)	6.0" (152,4 mm)	10 each	10 each per case
8427-12	054007-34459	250-400 kcmil (125-200 mm ²)	0.69" (17,5 mm)	1.38" (35,1 mm)	8.0" (203,2 mm)	12.0" (304,8 mm)	10 each	10 each per case
8427-12P	054007-42868	250-400 kcmil	0.69" (17,5 mm)	1.38" (35,1 mm)	8.0" (203,2 mm)	12.0" (304,8 mm)	10 each	10 each per case
8427-16	054007-34460	250-400 kcmil (125-200 mm ²)	0.69" (17,5 mm)	1.38" (35,1 mm)	12.0" (304,8 mm)	16.0" (406,4 mm)	10 each	10 each per case
8428-6	054007-09916	-	0.95" (24,1 mm)	1.94" (49,2 mm)	2.0" (50,8 mm)	6.0" (152,4 mm)	10 each	10 each per case
8428-6M	051128-53828	450-800 kcmil	0.95" (24,1 mm)	1.94" (49,2 mm)	2.0" (50,8 mm)	6.0" (152,4 mm)	50 each	50 each per case
8428-8	051128-53711	500-800 kcmil	0.95" (24,1 mm)	1.94" (49,2 mm)	3.0" (76,2 mm)	8.0" (203,2 mm)	25 each	25 each per case
8428-12	054007-09056	500-800 kcmil (300-400 mm ²)	0.95" (24,1 mm)	1.94" (49,2 mm)	8.0" (203,2 mm)	12.0" (304,8 mm)	10 each	10 each per case
8428-12M	054007-43746	500-800 kcmil	-	-	-	-	10 each	10 each per case
8428-12P	054007-42869	500-800 kcmil	0.95" (24,1 mm)	1.94" (49,2 mm)	8.0" (203,2 mm)	12.0" (304,8 mm)	10 each	10 each per case
8428-18	054007-34461	500-800 kcmil (300-400 mm ²)	0.95" (24,1 mm)	1.94" (49,2 mm)	14.0" (355,6 mm)	18.0" (457,2 mm)	10 each	10 each per case

Product Series	UPC	Typical Conductor Size	Min. Cable Diameter for Seal	Max.** Diam. Insulator Covers	Max. Connector Length	Relaxed Tube Length	Inner Unit Pack	Case Qty.
Single Conductor Cable								
8429-6	054007-09917	-	1.27" (32,2 mm)	2.67" (67,8 mm)	2.0" (50,8 mm)	6.0" (152,4 mm)	10 each	10 each per case
8429-9	054007-09931	900-1000 kcmil (500 mm ²)	1.27" (32,2 mm)	2.67" (67,8 mm)	5.0" (127,0 mm)	9.0" (228,6 mm)	10 each	10 each per case
8429-9M	054007-42018	900-1000 kcmil	1.27" (32,2 mm)	2.67" (67,8 mm)	5.0" (127,0 mm)	9.0" (228,6 mm)	10 each	10 each per case
8429-12	054007-42389	900-1000 kcmil (500 mm ²)	1.27" (32,2 mm)	2.67" (67,8 mm)	8.0" (203,2 mm)	12.0" (304,8 mm)	10 each	10 each per case
8429-15	054007-44198	900-1000 kcmil (500 mm ²)	1.27" (32,2 mm)	2.67" (67,8 mm)	11.0" (279,4 mm)	15.0" (381,0 mm)	10 each	10 each per case
8429-18	054007-34462	900-1000 kcmil (500 mm ²)	1.27" (32,2 mm)	2.67" (67,8 mm)	14.0" (355,6 mm)	18.0" (457,2 mm)	10 each	10 each per case
8430-9	054007-42147	1250-2000 kcmil	1.68" (42,6 mm)	3.69" (93,7 mm)	5.0" (127,0 mm)	9.0" (228,6 mm)	10 each	10 each per case
8430-18	054007-42388	1250-2000 kcmil	1.68" (42,6 mm)	3.69" (93,7 mm)	14.0" (355,6 mm)	18.0" (457,2 mm)	10 each	10 each per case

Product Series	UPC	Typical Conductor Size	Min. Cable Diameter for Seal	Max. Diam. Insulator Cable or Connector Covers	Relaxed Tube Length	Min. Order Quantity	Case Qty.
Single Conductor Cable							
8443-2	054007-09485	6-2 AWG (14-30 mm ²)	0.27" (6,9 mm)	0.56" (14,2 mm)	2.00" (50,8 mm)	12 each	12 each per case
8443-6.5	054007-09482	6-2 AWG (14-30 mm ²)	0.27" (6,9 mm)	0.56" (14,2 mm)	6.50" (165,1 mm)	12 each	12 each per case
8445-2.5	054007-09486	2-1/0 AWG (35-50 mm ²)	0.35" (8,9 mm)	0.72" (18,3 mm)	2.50" (63,5 mm)	12 each	12 each per case
8445-7.5	054007-09483	2-1/0 AWG (35-50 mm ²)	0.35" (8,9 mm)	0.72" (18,3 mm)	7.50" (190,5 mm)	12 each	12 each per case
8447-3.2	054007-09487	1/0-3/0 AWG (60-80 mm ²)	0.48" (12,2 mm)	0.95" (24,1 mm)	3.20" (81,3 mm)	12 each	12 each per case
8447-8	054007-09484	1/0-3/0 AWG (60-80 mm ²)	0.48" (12,2 mm)	0.95" (24,1 mm)	8.00" (203,2 mm)	12 each	12 each per case

Other 3M™ Electrical Insulation Products



11



12



13

Tape and Related Products

3M offers a wide variety of electrical and electronic insulating tapes for insulating, holding, protecting, bonding, resin impregnation, harnessing and electromagnetic compatibility. These products have key industry component recognition, such as UL, and excellent mechanical, electrical and physical properties. 3M™ Insulating and Conductive Tapes are designed to provide a high level of protection for electrical and electronic components. All 3M tapes and related products feature exceptionally high quality backed by experienced technical support.

Liquid Resins

3M™ Scotchcast™ Electrical Liquid Resins are 100-percent solid, thermosetting, electrical-grade insulating resins. These two-part liquids are classified chemically as either epoxies or polyurethanes. These resins have electrical and physical properties that make them excellent for insulating and protecting electrical and electronic parts and assemblies.

Powder Resins

3M™ Scotchcast™ Powder Resins are a series of one-part, 100-percent-solid electrical-grade systems offering fast curing, excellent thermal and mechanical shock resistance, significant cut-through resistance, high adhesion, excellent chemical and moisture resistance, high-to-low flow characteristics, and excellent electrostatic coating capability. Insulation systems established per UL 1446 and IEC 85 requirements are available in this family of resins up to Class H (180° C).

3M, Scotchcast and Scotchweld are trademarks of 3M Company.

Important Notice

All statements, technical information, and recommendations related to 3M's products are based on information believed to be reliable, but the accuracy or completeness is not guaranteed. Before using this product, you must evaluate it and determine if it is suitable for your intended application. You assume all risks and liability associated with such use. Any statements related to the product which are not contained in 3M's current publications, or any contrary statements contained on your purchase order shall have no force or effect unless expressly agreed upon, in writing, by an authorized officer of 3M.

Warranty; Limited Remedy; Limited Liability.

3M's product warranty is stated in its Product Literature available upon request. **3M MAKES NO OTHER WARRANTIES INCLUDING, BUT NOT LIMITED TO, ANY IMPLIED WARRANTY OF MERCHANTABILITY OR FITNESS FOR A PARTICULAR PURPOSE.** If this product is defective within the warranty period stated above, your exclusive remedy shall be, at 3M's option, to replace or repair the 3M product or refund the purchase price of the 3M product. **Except where prohibited by law, 3M will not be liable for any indirect, special, incidental or consequential loss or damage arising from this 3M product, regardless of the legal theory asserted.**



Electrical Markets Division

6801 River Place Blvd.
Austin, TX 78726-9000
800/676 8381
Fax 800/828 9329
www.3M.com/oem

Please recycle. Printed in USA.
© 3M 2014. All rights reserved.
80-6109-4450-8 F