



Excellent Integrated System Limited

Stocking Distributor

Click to view price, real time Inventory, Delivery & Lifecycle Information:

[ITT Cannon, LLC](#)
[CA3100F18-1SB](#)

For any questions, you can email us directly:

sales@integrated-circuit.com

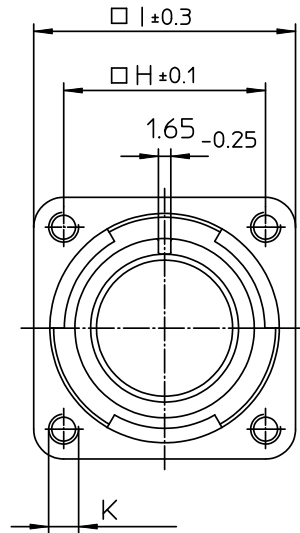
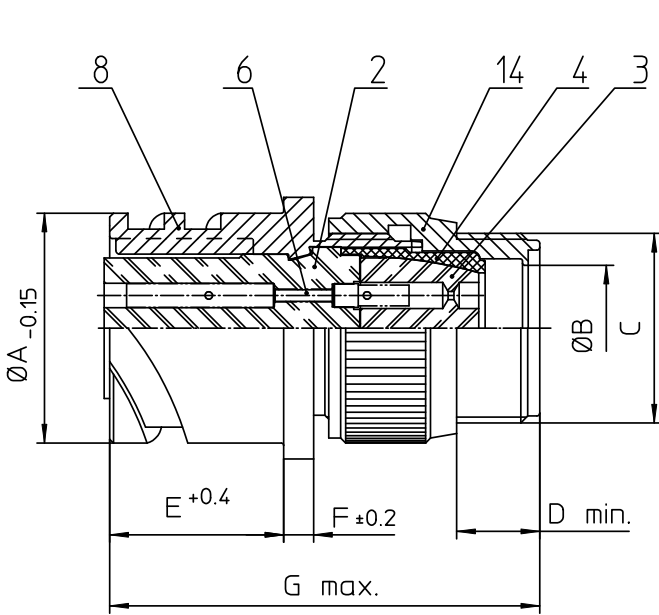

NO.	MASSE / DIMENSION
A	30.8
B	16.7
C	1-20UNEF-2A
D	9.5
E	23.05
F	4
G	59
H	27
I	35
K	M4

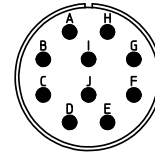

NO.	BESCHREIBUNG / DESCRIPTION
2	ISOLIERKÖRPER BUCHSE / INSULATOR SOCKET
3	DICKTKÖRPER / GROMMET
4	ENDRING / ENDRING
6	KONTAKTBUCHSE / CONTACT SOCKET
8	DOSENGEHÄUSE / SHELL
14	F-ENDGEHÄUSE / F-ENDBELL

Note: Due to an automatic nomenclature system, numbers generated may not be sequential.
Specification and Dimensions subject to change
Drawings illustrate normal insulator positioning

Material Specification:	
Shell Material:	Aluminium alloy
Shell Plating:	Olive drab chromate over cadmium (conductive)
Insulator Material:	CR-Elastomere
Contact Material:	Copper alloy
Contact Plating:	Hard silver

all dimensions are in mm

Dimensions without tolerance indications are general tolerances in acc. with DIN7168m

drawing for
CUSTOMER



Engineered for life
ITT CANNON GmbH
D-71284 Wernau/Germany

description CA3100F18-1S-B
Wall mounting receptacle
Endbell for flex tube
Solder Cup / Socket / Layout: 18-1

© All rights reserved. Reproduction or issue to third in any form
whenever is only permitted with written authorization of ITT Cannon



page 1/1
revision 786 4, Jul 16