

Excellent Integrated System Limited

Stocking Distributor

Click to view price, real time Inventory, Delivery & Lifecycle Information:

[Phoenix Contact](#)
[1668470](#)

For any questions, you can email us directly:

sales@integrated-circuit.com



Extract from the online catalog

SAC-4P-M12MS/ 0,3-PUR/M12FR

Order No.: 1668470



<http://eshop.phoenixcontact.de/phoenix/treeViewClick.do?UID=1668470>

Sensor/Actuator cable, 4-position, PUR, halogen-free, Black-gray RAL 7021, Plug, straight M12, A-coded, on Socket, angled M12, A-coded, Cable length: 0.3 m

Commercial data	
GTIN (EAN)	 4 017918 137199
sales group	D111
Pack	1 pcs.
Customs tariff	85444290
Catalog page information	Page 82 (PC-2009)

Product notes

WEEE/RoHS-compliant since:
12/01/2005



<http://www.download.phoenixcontact.com>
Please note that the data given here has been taken from the online catalog. For comprehensive information and data, please refer to the user documentation. The General Terms and Conditions of Use apply to Internet downloads.

Technical data

General data	
Rated current at 40°C	4 A
Rated voltage	250 V
Number of positions	4
Volume resistance	≤ 5 mΩ

SAC-4P-M12MS/ 0,3-PUR/M12FR Order No.: 1668470
<http://eshop.phoenixcontact.de/phoenix/treeViewClick.do?UID=1668470>

Insulation resistance	≥ 10 MΩ
Length of cable	0.3 m
Ambient temperature (operation)	-25 °C ... 90 °C (Male connector / female connector)

General characteristics

Standards/regulations	M12 connector IEC 61076-2-101
Coding	A - standard
Surge voltage category	II
Pollution degree	3
Degree of protection	IP65/IP68/IP69K
Insertion/withdrawal cycles	≥ 100
Contact material	CuSn
Contact surface material	Ni/Au
Contact carrier material	TPU GF
Material of grip body	TPU, hardly inflammable, self-extinguishing
Material, knurls	Zinc die-cast, (nickel-plated)
Sealing material	NBR
Status display	No

Conductor data

Cable type	PUR halogen-free black
Cable type (abbreviation)	PUR
Cable abbreviation	Li9Y11Y-HF
Conductor cross section	0.34 mm ²
AWG signal line	22
Conductor structure signal line	42x 0.10 mm
Core diameter including insulation	1.27 mm ±0.02 mm
Thickness, insulation	≥ 0.21 mm (Core insulation)
	≥ 0.8 mm (Outer cable sheath)
External cable diameter	4.7 mm ±0.15 mm
Wire colors	Black, brown, blue, white
External sheath, color	Black-gray RAL 7021
Insulation resistance	≥ 100 MΩ*km
Conductor resistance	≤ 58 Ω/km (at 20°C)
Nominal voltage, conductor	≤ 300 V
Test voltage, conductor	≥ 3000 V

SAC-4P-M12MS/ 0,3-PUR/M12FR Order No.: 1668470

<http://eshop.phoenixcontact.de/phoenix/treeViewClick.do?UID=1668470>

Overall twist	4 wires, twisted
Length of twist, overall twist	49.5 mm
Outer sheath, material	PUR
Material conductor insulation	PP
Conductor material	Bare Cu litz wires
Cable weight	30 kg/km
Smallest bending radius, fixed installation	23.5 mm
Smallest bending radius, movable installation	47 mm
Number of bending cycles	4000000
Bending radius	47 mm
Traversing path	10 m
Traversing rate	3 m/s
Acceleration	10 m/s ²
Ambient temperature (operation)	-40 °C ... 80 °C (cable, fixed installation)
	-25 °C ... 80 °C (cable, flexible installation)
Special properties	Flexible cable conduit capable
	Silicone-free
	Free of substances which would hinder coating with paint or varnish
Flame resistance	in accordance with DIN UL-Style 20549
	in accordance with FT1 as per UL 758
Halogen-free	in accordance with DIN VDE 0472 part 815
	in accordance with DIN EN 50267-2-1
Resistance to oil	in accordance with DIN EN 60811-2-1
Other resistance	Highly resistant to acids, alkaline solutions and solvents
	hydrolysis and microbe resistant

Certificates / Approvals



Certification

CUL Listed, GOST, UL Listed

SAC-4P-M12MS/ 0,3-PUR/M12FR Order No.: 1668470

<http://eshop.phoenixcontact.de/phoenix/treeViewClick.do?UID=1668470>

Diagrams/Drawings

Dimensioned drawing

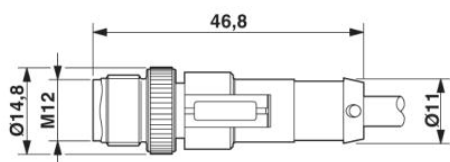

M12 x 1 male connector, straight

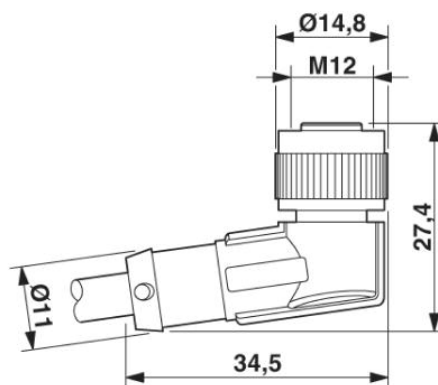

M12 x 1 female connector, angled

Circuit diagram



Contact assignment of the M12 plug and the M12 socket

Schematic diagram

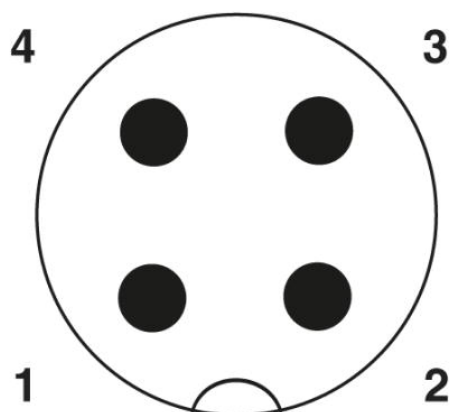

Pin assignment M12 plug, 4-pos., A-coded, view plug side

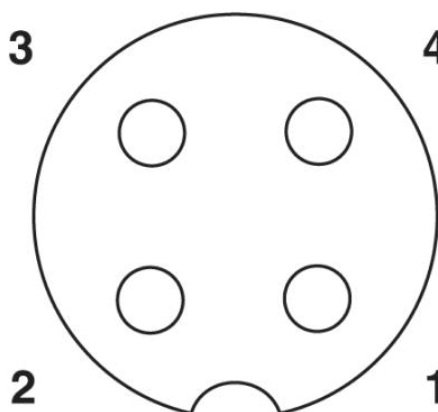

Pin assignment M12 socket, 4-pos., A-coded, view female side

SAC-4P-M12MS/ 0,3-PUR/M12FR Order No.: 1668470

<http://eshop.phoenixcontact.de/phoenix/treeViewClick.do?UID=1668470>

Address

PHOENIX CONTACT Deutschland GmbH
Flachsmarktstr. 8
32825 Blomberg, Germany
Phone +49 5235 3 12000
Fax +49 5235 3 41200
<http://www.phoenixcontact.de>



© 2011 Phoenix Contact
Technical modifications reserved;