



Excellent Integrated System Limited

Stocking Distributor

Click to view price, real time Inventory, Delivery & Lifecycle Information:

[ITT Cannon, LLC](#)
[CA3102E24-19PBF80-05](#)

For any questions, you can email us directly:

sales@integrated-circuit.com

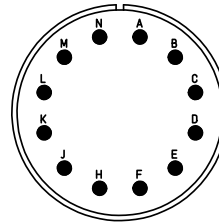
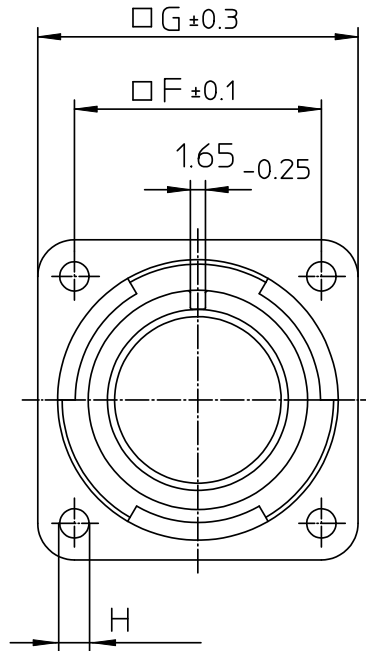
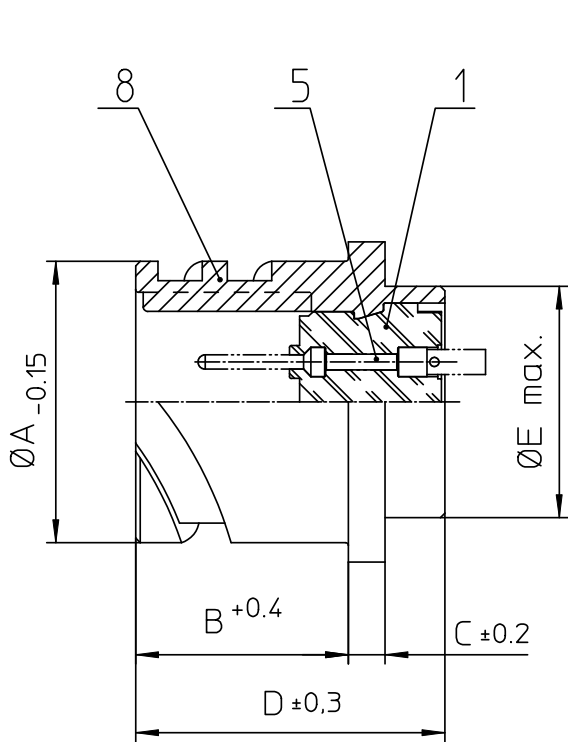

NO.	MASSE / DIMENSION
A	40.9
B	23.05
C	4
D	33.8
E	35.3
F	34.9
G	44.5
H	3.7

NO.	BESCHREIBUNG / DESCRIPTION
1	ISOLIERKÖRPER STIFT / INSULATOR PIN
5	KONTAKTSTIFT/ CONTACT PIN
8	DOSENGEHÄUSE / SHELL

Note: Due to an automatic nomenclature system, numbers generated may not be sequential.
 Specification and Dimensions subject to change
 Drawings illustrate normal insulator positioning

Material Specification:	
Shell Material:	Aluminium alloy
Shell Plating:	Olive drab chromate over cadmium (conductive)
Insulator Material:	CR-Elastomere
Contact Material:	Copper alloy
Contact Plating:	Hard silver

all dimensions are in mm
 Dimensions without tolerance indications are general tolerances in acc. with DIN7168m

drawing for
 CUSTOMER

ITT
 Engineered for life
 ITT CANNON GmbH
 D-71334 Heilbronn/Germany

description CA3102E24-19P-B-F80-05
 Box mounting receptacle (rear mount, through holes)

AWG Crimp / Pin / Layout: 24-19

© All rights reserved. Reproduction is issue to third in any form
 whatever is only permitted with written authorization of ITT Cannon

page 1/1
 revision 786 4. Jul 16