



Distributor of ITT Cannon, LLC: Excellent Integrated System Limited

Datasheet of CA3108E14S-5SF80 - CONN PLUG 5POS RT ANG W/SKTS

Contact us: sales@integrated-circuit.com Website: www.integrated-circuit.com

Excellent Integrated System Limited

Stocking Distributor

Click to view price, real time Inventory, Delivery & Lifecycle Information:

[ITT Cannon, LLC](#)

[CA3108E14S-5SF80](#)

For any questions, you can email us directly:

sales@integrated-circuit.com

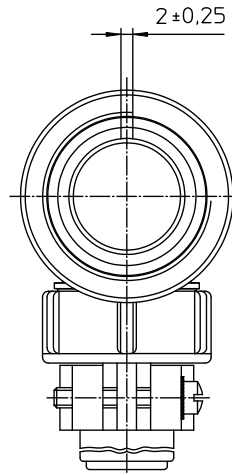
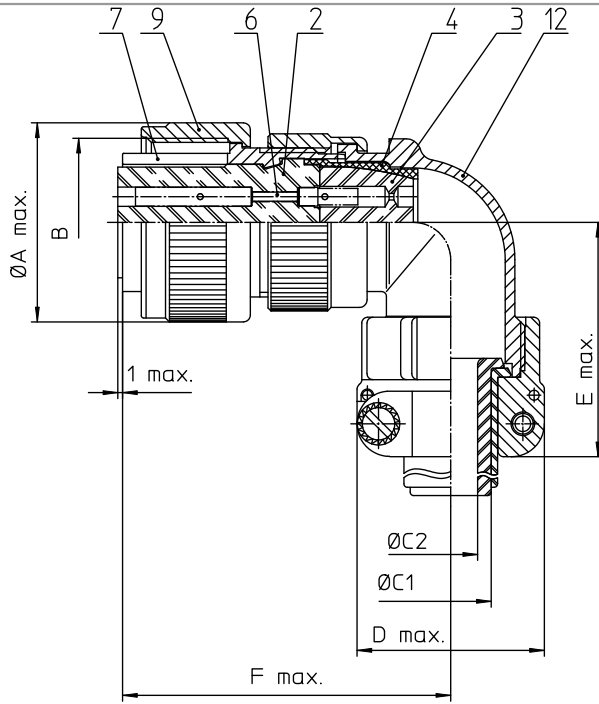

NO.	MASSE / DIMENSION
A	28.8
B	7/8-20UNEF-2B
C1	9.1
C2	-
D	27.5
E	42
F	47

NO.	BESCHREIBUNG / DESCRIPTION
2	ISOLIERKÖRPER BUCHSE / INSULATOR SOCKET
3	DICHTKÖRPER / GROMMET
4	ENDRING / ENDRING
6	KONTAKTBUCHSE / CONTACT SOCKET
7	ZYLINDERGHÄUSE / BARREL
9	ÜBERWURFMUTTER / COUPLING NUT
12	ENDGEHÄUSE / ENDBELL

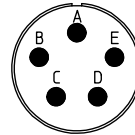

Note: Due to an automatic nomenclature system, numbers generated may not be sequential.
Specification and Dimensions subject to change Drawings illustrate normal insulator positioning
Material Specification:
Shell Material: Aluminium alloy
Shell Plating: Olive drab chromate coating over cadmium plating
Insulator Material: Neoprene
Contact Material: Copper alloy
Contact Plating: Hard silver

all dimensions are in mm Dimensions without tolerance indications are general tolerances in acc. with DIN7150m	drawing for CUSTOMER
 ITT <i>Engineered for life</i> ITT CANON CORP. 17108 Woodbridge Drive	description CA3108E14S-5S-F80 Plug 90° Endbell with clamp and bushing AWG Crimp / Socket / Layout: 14S-5
© All rights reserved. Reproduction or reuse in any form without the prior written authorization of ITT Cannon	revision page 1/1 377.3, Jul 16