

Excellent Integrated System Limited

Stocking Distributor

Click to view price, real time Inventory, Delivery & Lifecycle Information:

[Phoenix Contact](#)
[1927564](#)

For any questions, you can email us directly:

sales@integrated-circuit.com



Extract from the online catalog

MSTB 2,5/ 2-GF-5,08 THT

Order No.: 1927564

The illustration shows an 8-position version

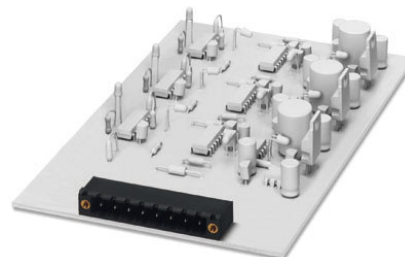

<http://eshop.phoenixcontact.de/phoenix/treeViewClick.do?UID=1927564>

Header, Nominal current: 12 A, Rated voltage (III/2): 320 V, Number of positions: 2, Pitch: 5.08 mm, Color: black, Metal surface: Sn, Assembly: SMD/THT/THR, User information and design recommendations on through hole reflow technology can be found at: <http://www.combicon.com>

Commercial data

GTIN (EAN)	 4 017918 821531
sales group	E172
Pack	50 pcs.
Customs tariff	85366990
Catalog page information	Page 147 (CC-2002)

Product notes

WEEE/RoHS-compliant since:
01/01/2003



<http://www.download.phoenixcontact.com>
Please note that the data given here has been taken from the online catalog. For comprehensive information and data, please refer to the user documentation. The General Terms and Conditions of Use apply to Internet downloads.

Technical data

Dimensions / positions

Length	12 mm
Pitch	5.08 mm
Dimension a	5.08 mm
Number of positions	2
Pin dimensions	1 x 1 mm
Hole diameter	1.4 mm

MSTB 2,5/ 2-GF-5,08 THT Order No.: 1927564
<http://eshop.phoenixcontact.de/phoenix/treeViewClick.do?UID=1927564>

Technical data

Range of articles	MSTB 2,5/...-GF-THT
Insulating material group	IIIa
Rated surge voltage (III/3)	4 kV
Rated surge voltage (III/2)	4 kV
Rated surge voltage (II/2)	4 kV
Rated voltage (III/2)	320 V
Rated voltage (II/2)	400 V
Connection in acc. with standard	EN-VDE
Nominal current I_N	12 A
Nominal voltage U_N	250 V
Maximum load current	12 A
Insulating material	PA
Inflammability class acc. to UL 94	V0
Nominal voltage, UL/CUL Use Group B	250 V
Nominal current, UL/CUL Use Group B	12 A
Nominal voltage, UL/CUL Use Group D	300 V
Nominal current, UL/CUL Use Group D	10 A

Certificates / Approvals



Certification

CB, CUL, GOST, UL, VDE-PZI

MSTB 2,5/ 2-GF-5,08 THT Order No.: 1927564

<http://eshop.phoenixcontact.de/phoenix/treeViewClick.do?UID=1927564>

Diagrams/Drawings

Drilling plan/solder pad geometry

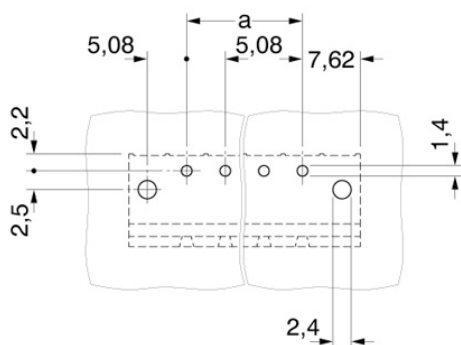

Dimensioned drawing

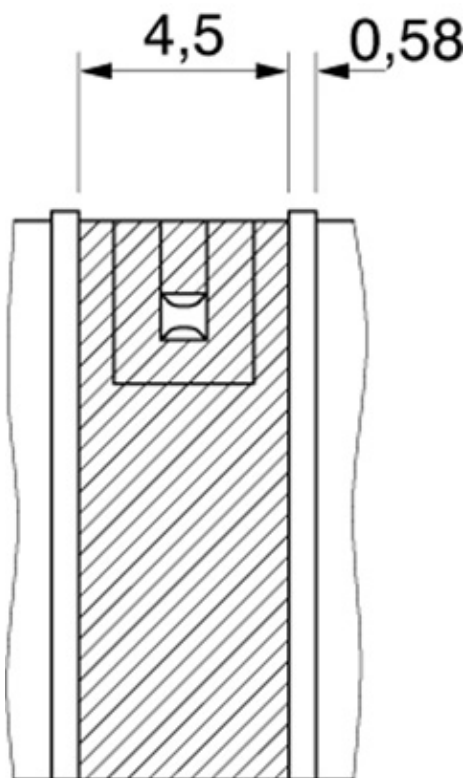
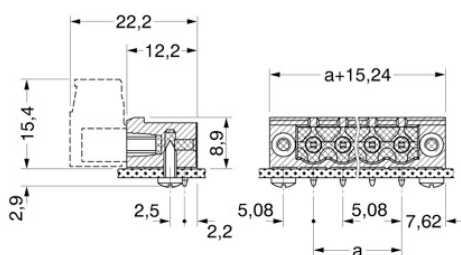

MSTB 2,5/ 2-GF-5,08 THT Order No.: 1927564

<http://eshop.phoenixcontact.de/phoenix/treeViewClick.do?UID=1927564>

Address

PHOENIX CONTACT Deutschland GmbH
Flachmarktstr. 8
32825 Blomberg, Germany
Phone +49 5235 3 12000
Fax +49 5235 3 41200
<http://www.phoenixcontact.de>



© 2010 Phoenix Contact
Technical modifications reserved;