

Excellent Integrated System Limited

Stocking Distributor

Click to view price, real time Inventory, Delivery & Lifecycle Information:

[Phoenix Contact](#)
[1872499](#)

For any questions, you can email us directly:

sales@integrated-circuit.com



Extract from the online catalog

A-MSTBVA 2,5/ 5-G-5,08

Order No.: 1872499

The illustration shows a 12-position version

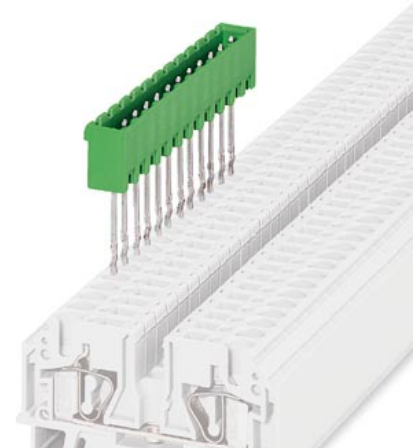

<http://eshop.phoenixcontact.de/phoenix/treeViewClick.do?UID=1872499>

Base strip, Nominal current: 12 A, Nominal voltage: 250 V, Mounting type: DIN rail mounting, Number of positions: 5, Pitch: 5.08 mm, Color: green

Commercial data	
GTIN (EAN)	4 017918 141998 
sales group	E124
Pack	50 pcs.
Customs tariff	85366990
Catalog page information	Page 224 (CC-2002)

Product notes

WEEE/RoHS-compliant since: 01/01/2003



<http://www.download.phoenixcontact.com>
 Please note that the data given here has been taken from the online catalog. For comprehensive information and data, please refer to the user documentation. The General Terms and Conditions of Use apply to Internet downloads.

Technical data

General	
Color	green

A-MSTBVA 2,5/ 5-G-5,08 Order No.: 1872499
<http://eshop.phoenixcontact.de/phoenix/treeViewClick.do?UID=1872499>

Insulating material	PBT
Inflammability class acc. to UL 94	V0

Certificates / Approvals



Certification CUL, GOST, UL

Accessories

Item	Designation	Description
Assembly		
1755477	MSTB-BL	Keying cap, for forming sections, plugs onto header pin, green insulating material

Marking		
0804293	SK 5,08/3,8:FORTL.ZAHLEN	Marker card, printed horizontally, self-adhesive, 12 identical decades marked 1-10, 11-20 etc. up to 91-(99)100, sufficient for 120 terminal blocks

Plug/Adapter		
1734401	CR-MSTB	Coding section, inserted into the recess in the header or the inverted plug, red insulating material

Tools		
3024287	ZFK-BW 2-5	Actuation tool, for loosening the tension spring, 2-pos.
3024290	ZFK-BW 3-5	Actuation tool, for loosening the tension spring, 3-pos.
3024300	ZFK-BW 10-5	Actuation tool, for loosening the tension spring, 10-pos.

Additional products

Item	Designation	Description
General		
1872729	A-ICV 2,5/ 5-G-5,08	Base strip, Nominal current: 12 A, Nominal voltage: 250 V, Mounting type: DIN rail mounting, Number of positions: 5, Pitch: 5.08 mm, Color: green

A-MSTBVA 2,5/ 5-G-5,08 Order No.: 1872499

<http://eshop.phoenixcontact.de/phoenix/treeViewClick.do?UID=1872499>

1873087	FKC 2,5/ 5-ST-5,08	Plug component, Nominal current: 12 A, Rated voltage (III/2): 320 V, Number of positions: 5, Pitch: 5.08 mm, Color: green, Metal surface: Sn
1902149	FKCT 2,5/ 5-ST-5,08	Plug component, Nominal current: 12 A, Rated voltage (III/2): 320 V, Number of positions: 5, Pitch: 5.08 mm, Color: green, Metal surface: Sn
1873980	FKCVR 2,5/ 5-ST-5,08	Plug component, Nominal current: 12 A, Rated voltage (III/2): 320 V, Number of positions: 5, Pitch: 5.08 mm, Color: green, Metal surface: Sn
1873689	FKCVW 2,5/ 5-ST-5,08	Plug component, Nominal current: 12 A, Rated voltage (III/2): 320 V, Number of positions: 5, Pitch: 5.08 mm, Color: green, Metal surface: Sn
1777316	FRONT-MSTB 2,5/ 5-ST-5,08	Plug component, Nominal current: 12 A, Rated voltage (III/2): 320 V, Number of positions: 5, Pitch: 5.08 mm, Color: green, Metal surface: Sn
1786433	IC 2,5/ 5-G-5,08	Header, Nominal current: 12 A, Rated voltage (III/2): 320 V, Number of positions: 5, Pitch: 5.08 mm, Color: green, Metal surface: Sn, Assembly: Soldering
1785971	ICV 2,5/ 5-G-5,08	Header, Nominal current: 12 A, Rated voltage (III/2): 320 V, Number of positions: 5, Pitch: 5.08 mm, Color: green, Metal surface: Sn, Assembly: Soldering
1757048	MSTB 2,5/ 5-ST-5,08	Plug component, Nominal current: 12 A, Rated voltage (III/2): 320 V, Number of positions: 5, Pitch: 5.08 mm, Color: green, Metal surface: Sn
1776142	MSTB 2,5/ 5-STZ-5,08	Plug component, Nominal current: 12 A, Rated voltage (III/2): 320 V, Number of positions: 5, Pitch: 5.08 mm, Color: green, Metal surface: Sn
1808845	MSTBC 2,5/ 5-ST-5,08	Plug component, Nominal current: 12 A, Rated voltage (III/2): 320 V, Number of positions: 5, Pitch: 5.08 mm, Color: green, Metal surface: Sn, Corresponding female crimp contacts with current [A] and conductor cross section range [mm ²] data: 10A/MSTBC-MT 0,5-1,0 (3190564); 10A/MSTBC-MT 0,5-1,0 BA (3190645); 12A/MSTBC-MT 1,5-2,5 (3190551); 12A/MSTBC-MT 1,5-2,5 BA (3190658). BA = Bandkontakte
1809530	MSTBC 2,5/ 5-STZ-5,08	Plug component, Nominal current: 12 A, Rated voltage (III/2): 320 V, Number of positions: 5, Pitch: 5.08 mm, Color: green, Metal surface: Sn, Corresponding female crimp contacts with current [A] and conductor cross section range [mm ²] data: 10A/MSTBC-MT 0,5-1,0 (3190564); 10A/MSTBC-MT 0,5-1,0 BA (3190645); 12A/MSTBC-MT 1,5-2,5 (3190551); 12A/MSTBC-MT 1,5-2,5 BA (3190658). BA = Bandkontakte
1769049	MSTBP 2,5/ 5-ST-5,08	Plug component, Nominal current: 12 A, Rated voltage (III/2): 320 V, Number of positions: 5, Pitch: 5.08 mm, Color: green, Metal surface: Sn
1781014	MSTBT 2,5/ 5-ST-5,08	Plug component, Nominal current: 12 A, Rated voltage (III/2): 320 V, Number of positions: 5, Pitch: 5.08 mm, Color: green, Metal surface: Sn

A-MSTBVA 2,5/ 5-G-5,08 Order No.: 1872499

<http://eshop.phoenixcontact.de/phoenix/treeViewClick.do?UID=1872499>

1792278	MVSTBR 2,5/ 5-ST-5,08	Plug component, Nominal current: 12 A, Rated voltage (III/2): 320 V, Number of positions: 5, Pitch: 5.08 mm, Color: green, Metal surface: Sn
1792786	MVSTBW 2,5/ 5-ST-5,08	Plug component, Nominal current: 12 A, Rated voltage (III/2): 320 V, Number of positions: 5, Pitch: 5.08 mm, Color: green, Metal surface: Sn
1883284	QC 1/ 5-ST-5,08	Plug component, Nominal current: 10 A, Rated voltage (III/2): 630 V, Number of positions: 5, Pitch: 5.08 mm, Color: green, Metal surface: Sn
1826319	SMSTB 2,5/ 5-ST-5,08	Plug component, Nominal current: 12 A, Rated voltage (III/2): 320 V, Number of positions: 5, Pitch: 5.08 mm, Color: green, Metal surface: Sn
1853049	TMSTBP 2,5/ 5-ST-5,08	Plug component, Nominal current: 12 A, Rated voltage (III/2): 320 V, Number of positions: 5, Pitch: 5.08 mm, Color: green, Metal surface: Sn, The plug allows conductors to be looped through from module to module.

Diagrams/Drawings

Dimensioned drawing

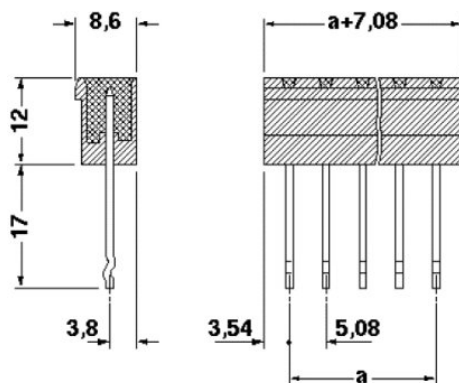

A-MSTBVA 2,5/ 5-G-5,08 Order No.: 1872499

<http://eshop.phoenixcontact.de/phoenix/treeViewClick.do?UID=1872499>

Address

PHOENIX CONTACT Deutschland GmbH
Flachsmarktstr. 8
32825 Blomberg, Germany
Phone +49 5235 3 12000
Fax +49 5235 3 41200
<http://www.phoenixcontact.de>



© 2010 Phoenix Contact
Technical modifications reserved;