

Excellent Integrated System Limited

Stocking Distributor

Click to view price, real time Inventory, Delivery & Lifecycle Information:

[Phoenix Contact](#)
[1788295](#)

For any questions, you can email us directly:

sales@integrated-circuit.com



Extract from the online catalog

UMSTBVK 2,5/20-G-5,08

Order No.: 1788295

The figure shows a 10-position version of the product



<http://eshop.phoenixcontact.de/phoenix/treeViewClick.do?UID=1788295>

Plug component, Nominal current: 12 A, Rated voltage (III/2): 320 V, Number of positions: 20, Pitch: 5.08 mm, Connection method: Screw connection, Color: green, Metal surface: Sn, Assembly: DIN rail

Commercial data

GTIN (EAN)	 4 017918 043353
sales group	E121
Pack	50 pcs.
Customs tariff	85366990
Catalog page information	Page 205 (CC-2005)

Product notes

WEEE/RoHS-compliant since:
01/01/2003



<http://www.download.phoenixcontact.com>
 Please note that the data given here has been taken from the online catalog. For comprehensive information and data, please refer to the user documentation. The General Terms and Conditions of Use apply to Internet downloads.

Technical data

Dimensions / positions

Width	42.5 mm
Pitch	5.08 mm
Dimension a	96.52 mm
Number of positions	20

UMSTBVK 2,5/20-G-5,08 Order No.: 1788295

<http://eshop.phoenixcontact.de/phoenix/treeViewClick.do?UID=1788295>

Screw thread	M3
Tightening torque, min	0.5 Nm
Tightening torque max	0.6 Nm

Technical data

Range of articles	UMSTBVK 2,5/...-G
Insulating material group	I
Rated surge voltage (III/3)	4 kV
Rated surge voltage (III/2)	4 kV
Rated surge voltage (II/2)	4 kV
Rated voltage (III/2)	320 V
Rated voltage (II/2)	630 V
Connection in acc. with standard	EN-VDE
Nominal current I_N	12 A
Nominal voltage U_N	320 V
Nominal cross section	2.5 mm ²
Insulating material	PA
Inflammability class acc. to UL 94	V2
Internal cylindrical gage	A3
Stripping length	7 mm

Connection data

Conductor cross section solid min.	0.2 mm ²
Conductor cross section solid max.	2.5 mm ²
Conductor cross section stranded min.	0.2 mm ²
Conductor cross section stranded max.	2.5 mm ²
Conductor cross section stranded, with ferrule without plastic sleeve min.	0.25 mm ²
Conductor cross section stranded, with ferrule without plastic sleeve max.	2.5 mm ²
Conductor cross section stranded, with ferrule with plastic sleeve min.	0.25 mm ²
Conductor cross section stranded, with ferrule with plastic sleeve max.	2.5 mm ²
2 conductors with same cross section, solid min.	0.2 mm ²
2 conductors with same cross section, solid max.	1 mm ²
2 conductors with same cross section, stranded min.	0.2 mm ²

UMSTBVK 2,5/20-G-5,08 Order No.: 1788295

<http://eshop.phoenixcontact.de/phoenix/treeViewClick.do?UID=1788295>

2 conductors with same cross section, stranded max.	1.5 mm ²
2 conductors with same cross section, stranded, ferrules without plastic sleeve, min.	0.25 mm ²
2 conductors with same cross section, stranded, ferrules without plastic sleeve, max.	1 mm ²
2 conductors with same cross section, stranded, TWIN ferrules with plastic sleeve, min.	0.5 mm ²
2 conductors with same cross section, stranded, TWIN ferrules with plastic sleeve, max.	1.5 mm ²
Conductor cross section AWG/kcmil min.	24
Conductor cross section AWG/kcmil max	12

Certificates / Approvals

Certification CB, CSA, CUL, GOST, UL, VDE-PZI

Accessories

Item	Designation	Description
------	-------------	-------------

Assembly

1755477	MSTB-BL	Keying cap, for forming sections, plugs onto header pin, green insulating material
---------	---------	--

General

1733169	EBP 2- 5	Insertion bridge, fully insulated, for plug connectors with 5.0 or 5.08 mm pitch, no. of positions: 2
---------	----------	---

Marking

0804293	SK 5,08/3,8:FORTL.ZAHLEN	Marker card, printed horizontally, self-adhesive, 12 identical decades marked 1-10, 11-20 etc. up to 91-(99)100, sufficient for 120 terminal blocks
---------	--------------------------	---

Plug/Adapter

1734401	CR-MSTB	Coding section, inserted into the recess in the header or the inverted plug, red insulating material
---------	---------	--

Tools

1205053	SZS 0,6X3,5	Actuation tool, for ST terminal blocks, insulated, also suitable for use as a bladed screwdriver, size: 0.6 x 3.5 x 100 mm, 2-component grip, with non-slip grip
---------	-------------	--

UMSTBVK 2,5/20-G-5,08 Order No.: 1788295
<http://eshop.phoenixcontact.de/phoenix/treeViewClick.do?UID=1788295>

Additional products

Item	Designation	Description
General		
1777468	FRONT-MSTB 2,5/20-ST-5,08	Plug component, Nominal current: 12 A, Rated voltage (III/2): 320 V, Number of positions: 20, Pitch: 5.08 mm, Connection method: Screw connection, Color: green, Metal surface: Sn
1757190	MSTB 2,5/20-ST-5,08	Plug component, Nominal current: 12 A, Rated voltage (III/2): 320 V, Number of positions: 20, Pitch: 5.08 mm, Connection method: Screw connection, Color: green, Metal surface: Sn
1808997	MSTBC 2,5/20-ST-5,08	Plug component, Nominal current: 12 A, Rated voltage (III/2): 320 V, Number of positions: 20, Pitch: 5.08 mm, Connection method: Crimp connection, Color: green, Metal surface: Sn, Corresponding female crimp contacts with current [A] and conductor cross section range [mm ²] data: 10A/MSTBC-MT 0,5-1,0 (3190564); 10A/MSTBC-MT 0,5-1,0 BA (3190645); 12A/MSTBC-MT 1,5-2,5 (3190551); 12A/MSTBC-MT 1,5-2,5 BA (3190658). BA = Bandkontakte
1809682	MSTBC 2,5/20-STZ-5,08	Plug component, Nominal current: 12 A, Rated voltage (III/2): 320 V, Number of positions: 20, Pitch: 5.08 mm, Connection method: Crimp connection, Color: green, Metal surface: Sn, Corresponding female crimp contacts with current [A] and conductor cross section range [mm ²] data: 10A/MSTBC-MT 0,5-1,0 (3190564); 10A/MSTBC-MT 0,5-1,0 BA (3190645); 12A/MSTBC-MT 1,5-2,5 (3190551); 12A/MSTBC-MT 1,5-2,5 BA (3190658). BA = Bandkontakte
1769191	MSTBP 2,5/20-ST-5,08	Plug component, Nominal current: 12 A, Rated voltage (III/2): 320 V, Number of positions: 20, Pitch: 5.08 mm, Connection method: Screw connection, Color: green, Metal surface: Sn
1792427	MVSTBR 2,5/20-ST-5,08	Plug component, Nominal current: 12 A, Rated voltage (III/2): 320 V, Number of positions: 20, Pitch: 5.08 mm, Connection method: Screw connection, Color: green, Metal surface: Sn
1792935	MVSTBW 2,5/20-ST-5,08	Plug component, Nominal current: 12 A, Rated voltage (III/2): 320 V, Number of positions: 20, Pitch: 5.08 mm, Connection method: Screw connection, Color: green, Metal surface: Sn
1850592	SMSTB 2,5/20-ST-5,08	Plug component, Nominal current: 12 A, Rated voltage (III/2): 320 V, Number of positions: 20, Pitch: 5.08 mm, Connection method: Screw connection, Color: green, Metal surface: Sn

UMSTBVK 2,5/20-G-5,08 Order No.: 1788295

<http://eshop.phoenixcontact.de/phoenix/treeViewClick.do?UID=1788295>

Diagrams/Drawings

Dimensioned drawing

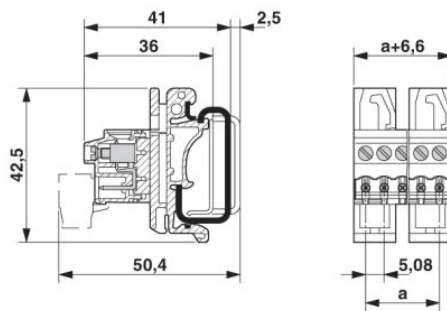

UMSTBVK 2,5/20-G-5,08 Order No.: 1788295

<http://eshop.phoenixcontact.de/phoenix/treeViewClick.do?UID=1788295>

Address

PHOENIX CONTACT Deutschland GmbH
Flachsmarktstr. 8
32825 Blomberg, Germany
Phone +49 5235 3 12000
Fax +49 5235 3 41200
<http://www.phoenixcontact.de>



© 2011 Phoenix Contact
Technical modifications reserved;