

## Excellent Integrated System Limited

Stocking Distributor

Click to view price, real time Inventory, Delivery & Lifecycle Information:

[Hammond Manufacturing](#)  
[DNRR63HDKB](#)

For any questions, you can email us directly:

[sales@integrated-circuit.com](mailto:sales@integrated-circuit.com)

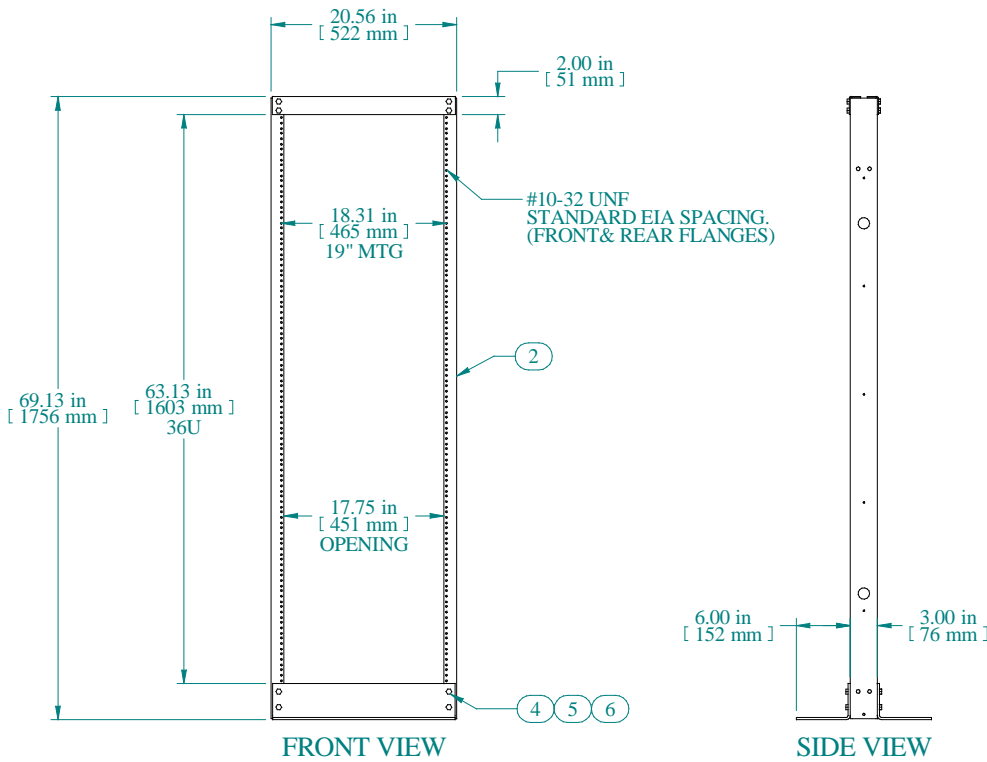
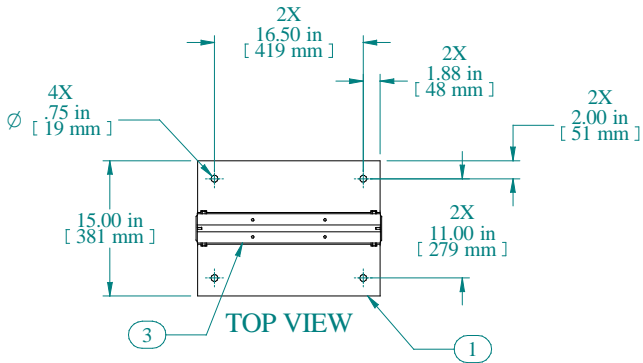

Item Number	Title	Quantity
1	DNRR - BASE ANGLE	2
2	DNRR - RAIL	2
3	DNRR - TOP ANGLE	2
4	SCREW 3/8-16 X 1	16
5	WASHER 3/8 SPLIT	16
6	NUT 3/8-16 HEX	16

PART NUMBERS	
DNRR63HDKB	PAINTED BLACK THIN FILM

NOTES
Shipped knockdown for handling ease & protection. See Hammond Website for Additional Accessories

Data subject to change without notice. Isometric drawing not to scale.

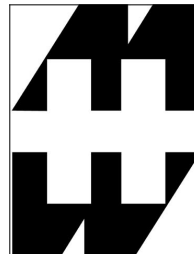

**HAMMOND  
MANUFACTURING™**

www.hammondmfg.com

PART NO. DNRR63HDKB