

Excellent Integrated System Limited

Stocking Distributor

Click to view price, real time Inventory, Delivery & Lifecycle Information:

[Peregrine Semiconductor](#)
[PE43204MLIBA-Z](#)

For any questions, you can email us directly:

sales@integrated-circuit.com

Product Specification

PE43204

50 Ω RF Digital Attenuator
2-bit; 0, 6, 12, and 18 dB States

Features

- HaRP™-enhanced UltraCMOS™ device
- Fast switching speed: Typical 26 ns
- High Linearity: Typical +61 dBm IP3
- Small α -Error
- Best in class 2000 V HBM ESD tolerance
- Attenuation: 6, 12, and 18 dB States
- Parallel Control
- CMOS Compatible
- Packaged in a 12-lead 3x3x0.85 mm QFN

Product Description

The PE43204 is a 50Ω, HaRP™-enhanced, high linearity, 2-bit RF Digital Step Attenuator (DSA) covering an 18 dB attenuation range in 6 dB steps. With a parallel control interface, it maintains high attenuation accuracy, fast switching speed, low insertion loss and low power consumption. This next generation Peregrine DSA is available in a 3x3 mm 12-lead QFN footprint.

The PE43204 is manufactured on Peregrine's UltraCMOS™ process, a patented variation of silicon-on-insulator (SOI) technology on a sapphire substrate, offering the performance of GaAs with the economy and integration of conventional CMOS.

Figure 1. Package Type

12-lead 3x3x0.85 mm QFN Package

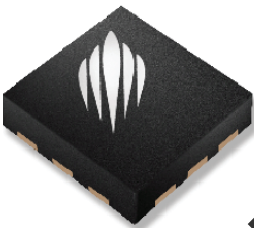

Figure 2. Functional Schematic Diagram

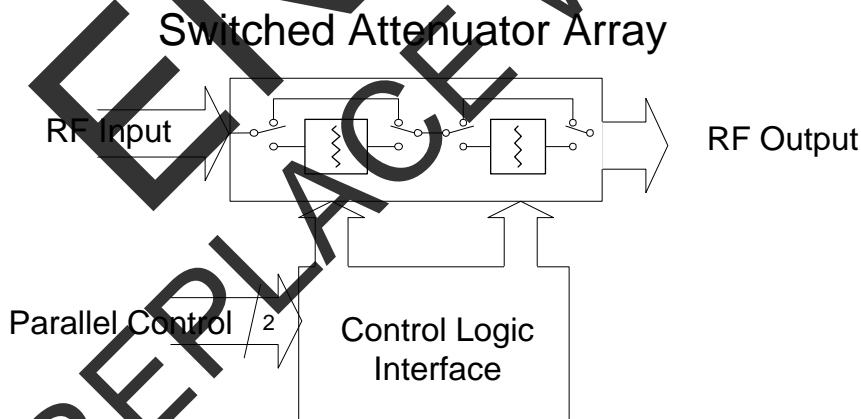

Table 1. Electrical Specifications @ +25°C, V_{DD} = 3.3 V

Parameter	Test Conditions	Min	Typical	Max	Units
Frequency Range			50 - 3000		MHz
Attenuation Range	6 dB, 12 dB and 18 dB steps		0 - 18		dB
Insertion Loss			0.6	0.7	dB
Attenuation Error	0 dB - 18 dB Attenuation Settings 50 MHz to < 2000 MHz 2000 MHz - 3000 MHz		+0.1	-0.25 / +0.40	dB
			+0.2	-0.10 / +0.50	dB
Return Loss			15		dB
Relative Phase	All States		11		deg
P1dB	Input	+28	+30		dBm
IIP3	IIP3 Two tones at +18 dBm, 20 MHz spacing		+61		dBm
Switching Speed	50% DC CTRL to 10% / 90% RF		26		ns

Performance Plots

Figure 3. Attenuation vs. Attenuation Setting

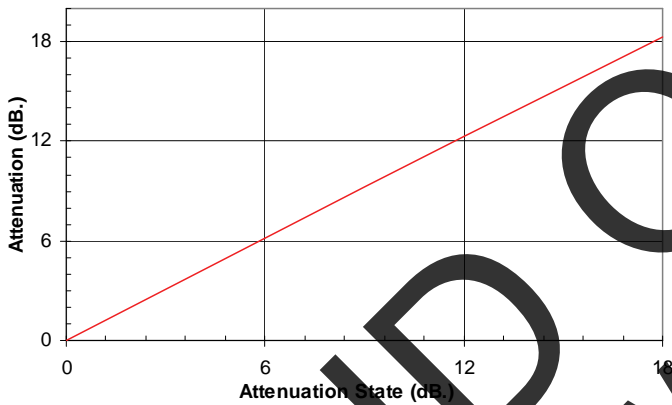
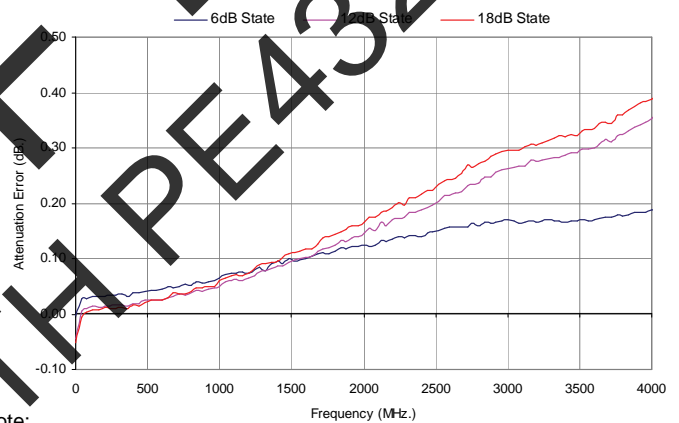

Figure 4. Attenuation Error vs. Frequency @ T = +25C



Note:
 Attenuation Error Equation - AE = [ABS { ABS(Insertion Loss @ Attenuation Setting) - ABS(Reference Loss) }] - [ABS(Attenuation Setting)]

Figure 5. Insertion Loss vs. Temperature

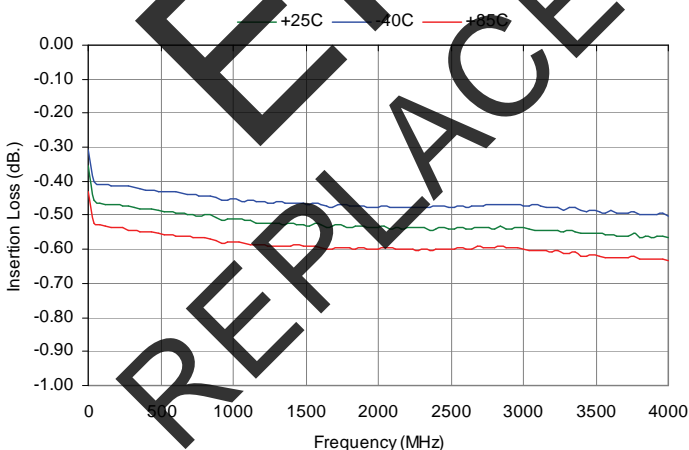
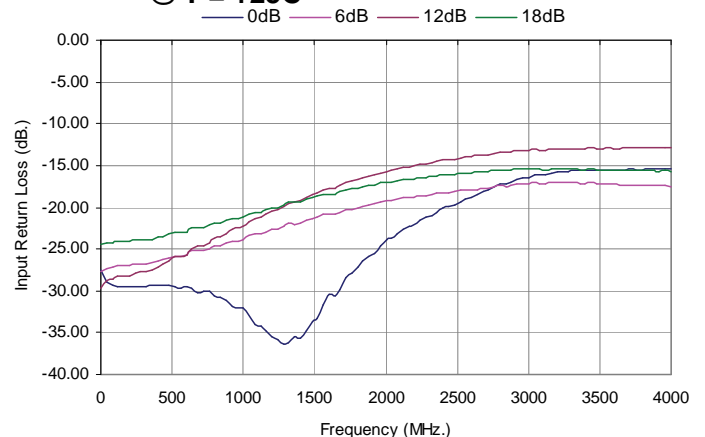

Figure 6. Input Return Loss vs Attenuation @ T = +25C



PE43204
Product Specification



Figure 7. Output Return Loss vs Attenuation @ T = +25C

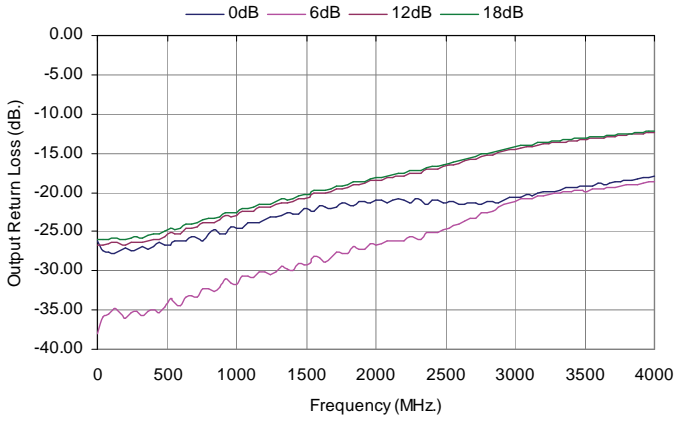

Figure 8. Input Return Loss vs Temperature @ 12dB State

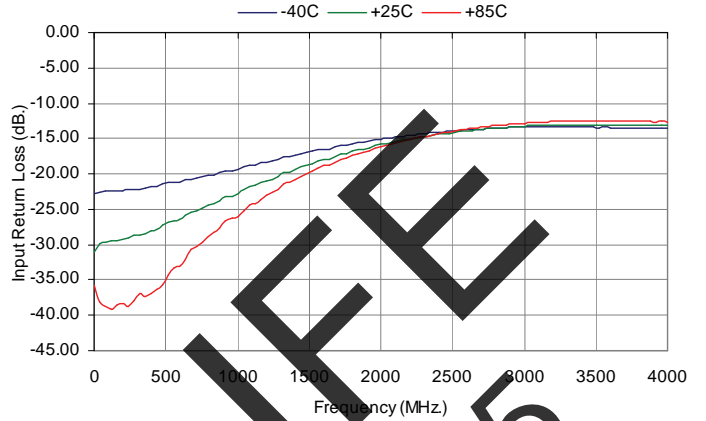

Figure 9. Output Return Loss vs Temperature @ 12dB State

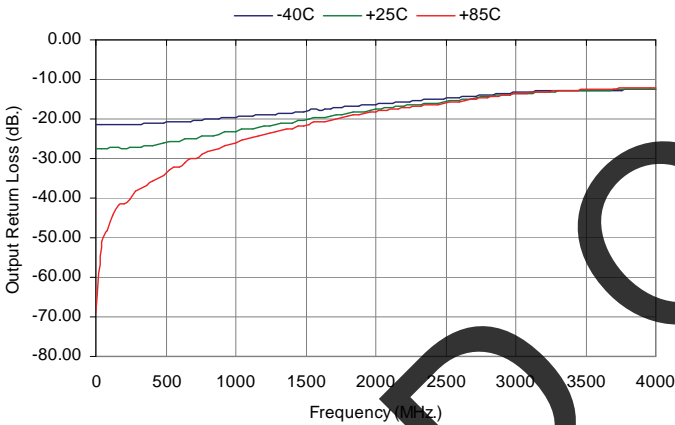
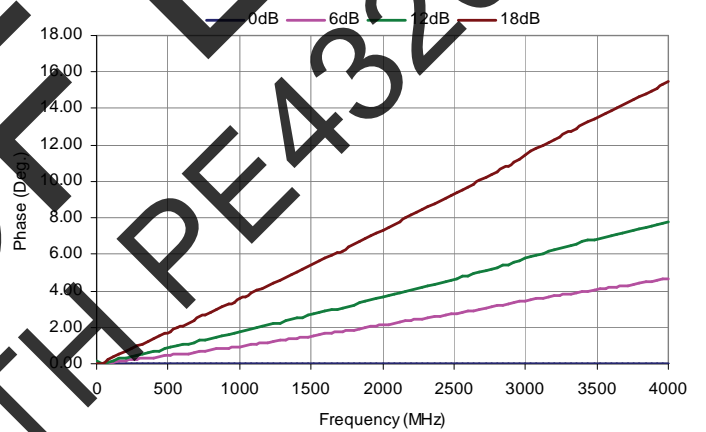

Figure 10. Relative Phase* vs Frequency @ T = +25C



*Relative Phase = Phase (attenuation state) – Phase (Insertion Loss state)

Figure 11. Input IP3 vs Attenuation Setting @ T = +25C

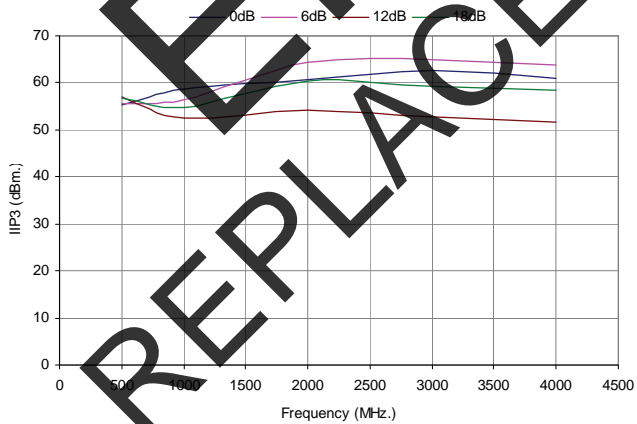

Figure 12. Attenuation Error vs. Attenuation Setting @ 3000 MHz

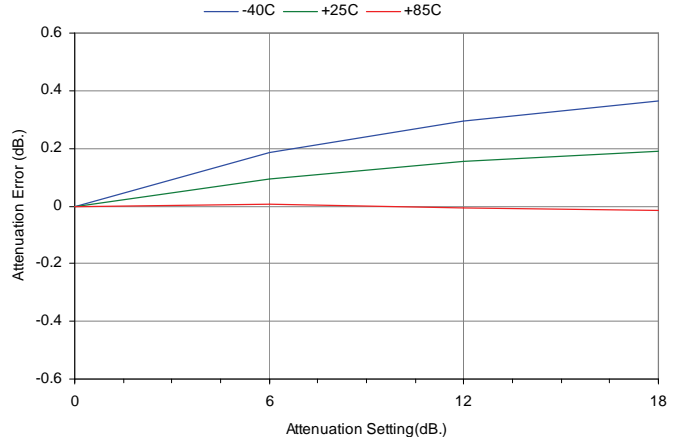

Figure 13. Pin Configuration (Top View)

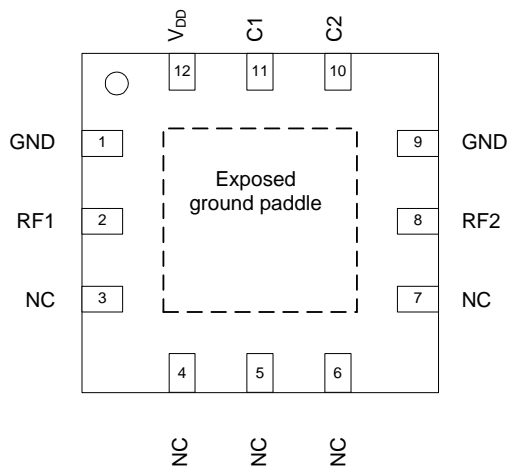

Table 2. Pin Descriptions

Pin No.	Pin Name	Description
1	GND	Ground
2	RF1 ²	RF1 port
3	NC ¹	No Connect
4	NC ¹	No Connect
5	NC ¹	No Connect
6	NC ¹	No Connect
7	NC ¹	No Connect
8	RF2 ²	RF2 port
9	GND	Ground
10	C2	Attenuation control bit, 12 dB
11	C1	Attenuation control bit, 6 dB
12	V _{DD}	Power Supply Pin

Notes: 1. Pins 3 through 7 may be tied to ground if desired, but they are not connected to ground internal to the package.
 2. All RF pins must be DC blocked with an external series capacitor or held at 0 VDC.

Exposed Solder Pad Connection

The exposed solder pad on the bottom of the package must be grounded for proper device operation.

Table 3. Attenuation Word Truth Table

C1	C2	Attenuation Setting RF1-RF2
L	L	Reference I.L.
H	L	6 dB
L	H	12 dB
H	H	18 dB

Table 4. Operating Ranges

Parameter	Min	Typ	Max	Units
V _{DD} Power Supply Voltage	3.0	3.3	3.6	V
I _{DD} Power Supply Current		8	200	μA
Digital Input High	0.7xV _{DD}		3.6	V
Digital Input Low	0		0.3xV _{DD}	V
Digital Input Leakage			10	μA
P _{IN} Input power (50Ω) 20 MHz ≤ 4.0 GHz			+23	dBm
T _{OP} Operating temperature range	-40	25	85	°C

Table 5. Absolute Maximum Ratings

Symbol	Parameter/Conditions	Min	Max	Units
V _{DD}	Power supply voltage	-0.3	+4.0	V
V _I	Voltage on any Digital input	-0.3	V _{DD} +0.3	V
T _{ST}	Storage temperature range	-65	150	°C
P _{IN}	Input power (50Ω) 20 MHz ≤ 4.0 GHz		+23	dBm
V _{ESD}	ESD voltage (Human Body Model, MIL-STD-883 Method 3015.7)		2000	V

Exceeding absolute maximum ratings may cause permanent damage. Operation should be restricted to the limits in the Operating Ranges table. Operation between operating range maximum and absolute maximum for extended periods may reduce reliability.

Electrostatic Discharge (ESD) Precautions

When handling this UltraCMOS™ device, observe the same precautions that you would use with other ESD-sensitive devices. Although this device contains circuitry to protect it from damage due to ESD, precautions should be taken to avoid exceeding the specified rating.

Latch-Up Avoidance

Unlike conventional CMOS devices, UltraCMOS™ devices are immune to latch-up.

Moisture Sensitivity Level

The Moisture Sensitivity Level rating for the PE43204 in the 12-lead 3x3 QFN package is MSL1.

Switching Frequency

The PE43204 has a maximum 25 kHz switching rate. Switching rate is defined to be the speed at which the DSA can be toggled across attenuation states.

PE43204

Product Specification



Evaluation Kit

The 2-bit DSA EK Board was designed to ease customer evaluation of Peregrine’s PE43204.

For automated programming, connect the test harness provided with the EVK to the parallel port of the PC and to the 6-pin header of the PCB. Connect the loose wire of the supplied cable to a power supply set at 3.3V DC. Set the SP3T switches S1 and S2 to the ‘MIDDLE’ toggle position. After downloading and installing the DSA EVK software from www.psemi.com, run the software and select ‘PE43204’ from the drop down menu. Using the software, enable or disable each setting to the desired attenuation state. The software automatically programs the DSA each time an attenuation state is enabled or disabled.

For manual programming, disconnect the test harness provided with the EVK. Apply 3.3V to the Vdd header pin and Ground to the GND header pin. The DUT can be controlled two ways:

1. *The mechanical switches in conjunction with the VCTL pin can be used.* Apply desired control voltage to VCTL header pin. The top mechanical switch controls the 6dB stage, the bottom mechanical switch controls the 12dB stage. For each switch, the left position is the 0V condition, while the right position is the Vctrl condition. The middle position leaves the control pin floating.
2. *The CTL1 and CTL2 pins on the header can be used.* Each pin directly controls the 6dB and 12dB stage respectively. The VCTL pin on the header is left open. The mechanical switches may be left uninstalled or must be kept in the middle position.

Note: To minimize switching time, C3 and C4 can be removed.

Power-up Control Settings

The PE43204 will always power up into the state determined by the voltages on the 2 control pins. The DSA can be preset to any state within the 18 dB range by pre-setting the parallel control pins prior to power-up. There is a 10µs delay between the time the DSA is powered-up to the time the desired state is set. If the control pins are left floating during power-up, the device will default to the minimum attenuation setting (insertion loss state).

Figure 14. Evaluation Board Layouts

Peregrine Specification 101/0344

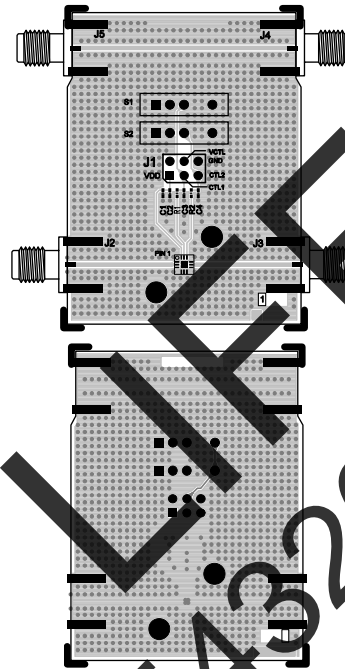

Figure 15. Evaluation Board Schematic

Peregrine Specification 102/0416

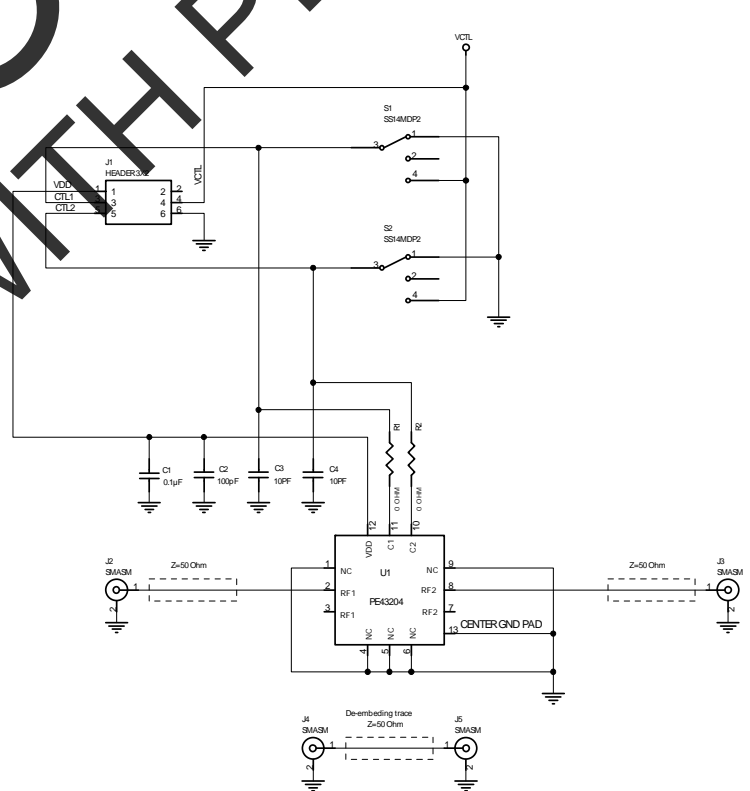
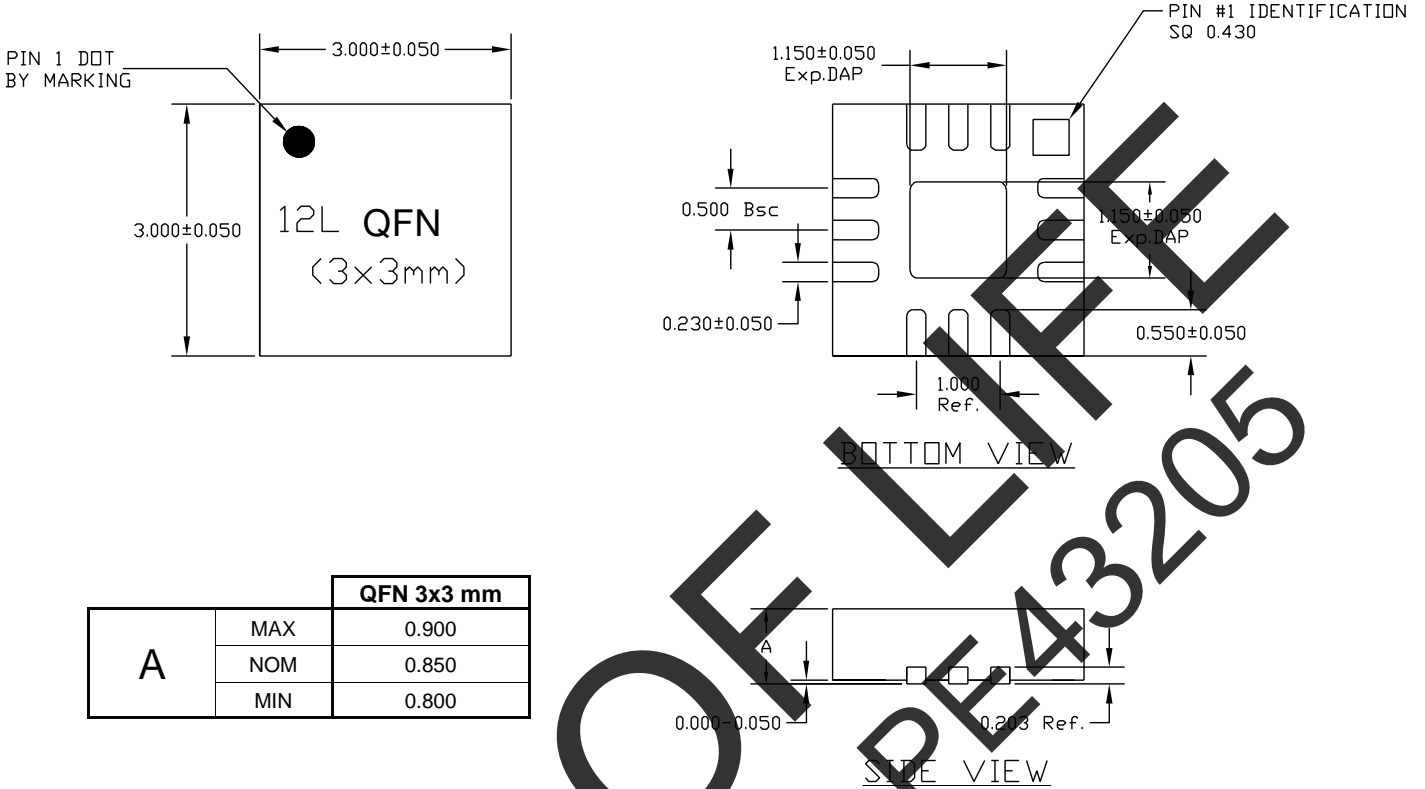

Figure 16. Package Drawing

3x3 mm 12-lead QFN, BOM 19/0104



Note: Pin 1 Identification tab is electrically connected to the exposed ground paddle

END OF LIFE
REPLACE WITH PE43205

PE43204
Product Specification



Figure 17. Tape and Reel Drawing

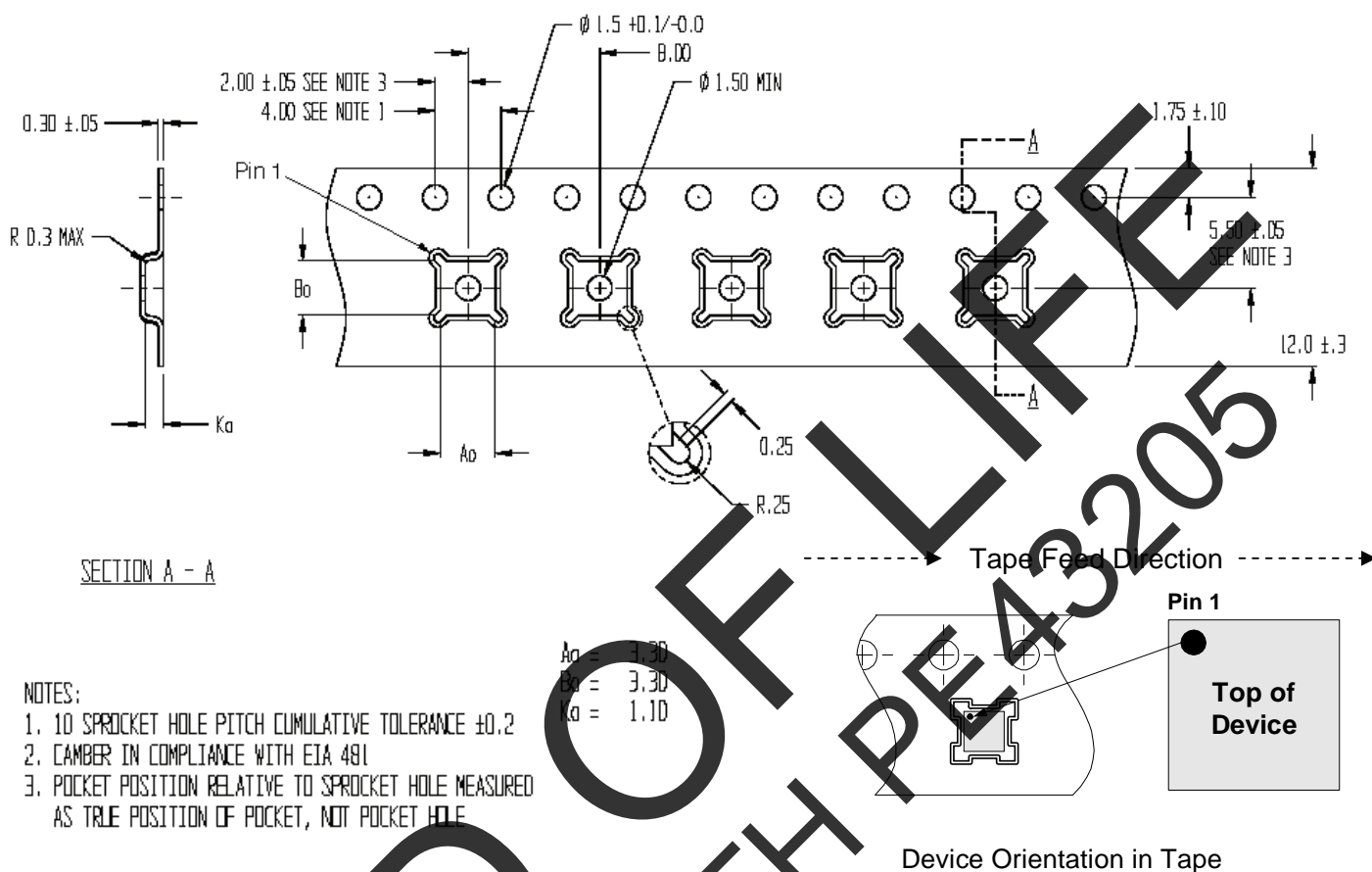

Figure 18. Marking Specifications

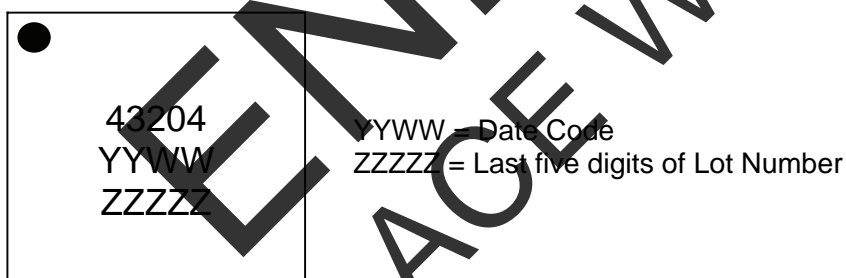

Table 6. Ordering Information

Order Code	Part Marking	Description	Package	Shipping Method
EK-43204-02	PE43204 -EK	PE43204 - 12QFN 3x3mm-EK	Evaluation Kit	1 / Box
PE43204MLIBA	43204	PE43204 G - 12QFN 3x3mm-75A	Green 12-lead 3x3mm QFN	Cut tape or loose
PE43204MLIBA-Z	43204	PE43204 G - 12QFN 3x3mm-3000C	Green 12-lead 3x3mm QFN	3000 units / T&R

Sales Offices

The Americas

Peregrine Semiconductor Corporation

9380 Carroll Park Drive
San Diego, CA 92121
Tel: 858-731-9400
Fax: 858-731-9499

Europe

Peregrine Semiconductor Europe

Bâtiment Maine
13-15 rue des Quatre Vents
F-92380 Garches, France
Tel: +33-1-4741-9173
Fax: +33-1-4741-9173

High-Reliability and Defense Products

Americas

San Diego, CA, USA
Phone: 858-731-9475
Fax: 848-731-9499

Europe/Asia-Pacific

Aix-En-Provence Cedex 3, France
Phone: +33-4-4239-3361
Fax: +33-4-4239-7227

Peregrine Semiconductor, Asia Pacific (APAC)

Shanghai, 200040, P.R. China
Tel: +86-21-5836-8276
Fax: +86-21-5836-7652

Peregrine Semiconductor, Korea

#B-2607, Kolon Tripolis, 210
Geumgok-dong, Bundang-gu, Seongnam-si
Gyeonggi-do, 463-943 South Korea
Tel: +82-31-728-3936
Fax: +82-31-728-3940

Peregrine Semiconductor K.K., Japan

Teikoku Hotel Tower 10B-6
1-1-1 Uchisaiwai-cho, Chiyoda-ku
Tokyo 100-0011 Japan
Tel: +81-3-3502-5211
Fax: +81-3-3502-5213

For a list of representatives in your area, please refer to our Web site at: www.psemi.com

Data Sheet Identification

Advance Information

The product is in a formative or design stage. The data sheet contains design target specifications for product development. Specifications and features may change in any manner without notice.

Preliminary Specification

The data sheet contains preliminary data. Additional data may be added at a later date. Peregrine reserves the right to change specifications at any time without notice in order to supply the best possible product.

Product Specification

The data sheet contains final data. In the event Peregrine decides to change the specifications, Peregrine will notify customers of the intended changes by issuing a CNF (Customer Notification Form).

The information in this data sheet is believed to be reliable. However, Peregrine assumes no liability for the use of this information. Use shall be entirely at the user's own risk.

No patent rights or licenses to any circuits described in this data sheet are implied or granted to any third party.

Peregrine's products are not designed or intended for use in devices or systems intended for surgical implant, or in other applications intended to support or sustain life, or in any application in which the failure of the Peregrine product could create a situation in which personal injury or death might occur. Peregrine assumes no liability for damages, including consequential or incidental damages, arising out of the use of its products in such applications.

The Peregrine name, logo, and UTSi are registered trademarks and UltraCMOS, HaRP, MultiSwitch and DuNE are trademarks of Peregrine Semiconductor Corp.