

Excellent Integrated System Limited

Stocking Distributor

Click to view price, real time Inventory, Delivery & Lifecycle Information:

[Orion Fans](#)

[G92P](#)

For any questions, you can email us directly:

sales@integrated-circuit.com

Part No. G92P



Plastic Fan Guard
for 92mm fans

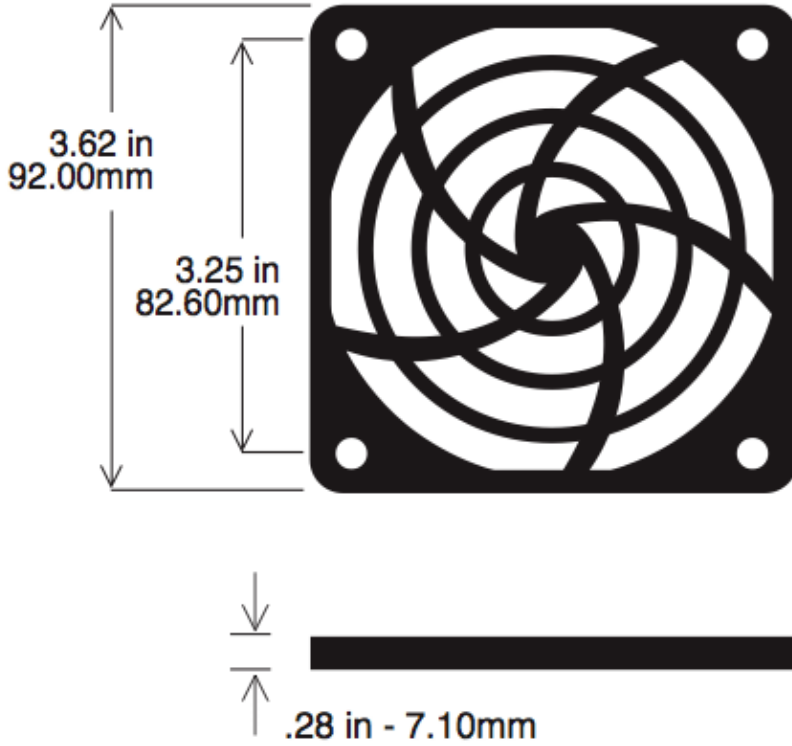

Material

Plastic - reinforced ABS
UL approved
Rating UL94V-O

Part Number	Description
G92P	92mm fan guard, plastic
G92P/PK	10-Pack G92P, Boxed