

Excellent Integrated System Limited

Stocking Distributor

Click to view price, real time Inventory, Delivery & Lifecycle Information:

[Vishay/Siliconix](#)
[SQD50N06-09L-GE3](#)

For any questions, you can email us directly:

sales@integrated-circuit.com



www.vishay.com

SQD50N06-09L

Vishay Siliconix

Automotive N-Channel 60 V (D-S) 175 °C MOSFET

PRODUCT SUMMARY	
V _{DS} (V)	60
R _{DS(on)} (Ω) at V _{GS} = 10 V	0.009
R _{DS(on)} (Ω) at V _{GS} = 4.5 V	0.013
I _D (A)	50
Configuration	Single

FEATURES

- Halogen-free According to IEC 61249-2-21 Definition
- TrenchFET® Power MOSFET
- 100 % R_g and UIS Tested
- Compliant to RoHS Directive 2002/95/EC
- AEC-Q101 Qualified^d



TO-252

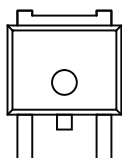

G D S

Top View

Drain Connected to Tab

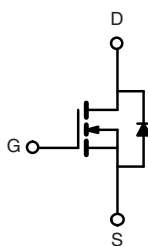

N-Channel MOSFET

ORDERING INFORMATION	
Package	TO-252
Lead (Pb)-free and Halogen-free	SQD50N06-09L-GE3

ABSOLUTE MAXIMUM RATINGS (T _C = 25 °C, unless otherwise noted)				
PARAMETER		SYMBOL	LIMIT	UNIT
Drain-Source Voltage		V _{DS}	60	V
Gate-Source Voltage		V _{GS}	± 20	
Continuous Drain Current	T _C = 25 °C ^a	I _D	50	A
	T _C = 125 °C		49	
Continuous Source Current (Diode Conduction) ^a		I _S	50	
Pulsed Drain Current ^b		I _{DM}	200	
Single Pulse Avalanche Energy	L = 0.1 mH	I _{AS}	48	
Single Pulse Avalanche Current		E _{AS}	115	
Maximum Power Dissipation ^b	T _C = 25 °C	P _D	136	W
	T _C = 125 °C		45	
Operating Junction and Storage Temperature Range		T _J , T _{stg}	- 55 to + 175	°C

THERMAL RESISTANCE RATINGS				
PARAMETER		SYMBOL	LIMIT	UNIT
Junction-to-Ambient	PCB Mount ^c	R _{thJA}	50	°C/W
Junction-to-Case (Drain)		R _{thJC}	1.1	

Notes

- Package limited.
- Pulse test; pulse width ≤ 300 μs, duty cycle ≤ 2 %.
- When mounted on 1" square PCB (FR-4 material).
- Parametric verification ongoing.



SPECIFICATIONS (T _C = 25 °C, unless otherwise noted)						
PARAMETER	SYMBOL	TEST CONDITIONS	MIN.	TYP.	MAX.	UNIT
Static						
Drain-Source Breakdown Voltage	V _{DS}	V _{GS} = 0 V, I _D = 250 μA	60	-	-	V
Gate-Source Threshold Voltage	V _{GS(th)}	V _{DS} = V _{GS} , I _D = 250 μA	1.5	2.0	2.5	
Gate-Source Leakage	I _{GSS}	V _{DS} = 0 V, V _{GS} = ± 20 V	-	-	± 100	nA
Zero Gate Voltage Drain Current	I _{DSS}	V _{GS} = 0 V V _{DS} = 60 V	-	-	1.0	μA
		V _{GS} = 0 V V _{DS} = 60 V, T _J = 125 °C	-	-	50	
		V _{GS} = 0 V V _{DS} = 60 V, T _J = 175 °C	-	-	250	
On-State Drain Current ^a	I _{D(on)}	V _{GS} = 10 V V _{DS} ≥ 5 V	50	-	-	A
Drain-Source On-State Resistance ^a	R _{DS(on)}	V _{GS} = 10 V I _D = 20 A	-	0.0071	0.0090	Ω
		V _{GS} = 10 V I _D = 20 A, T _J = 125 °C	-	-	0.016	
		V _{GS} = 10 V I _D = 20 A, T _J = 175 °C	-	-	0.019	
		V _{GS} = 4.5 V I _D = 10 A	-	0.0094	0.013	
Forward Transconductance ^b	g _{fs}	V _{DS} = 15 V, I _D = 20 A	-	62	-	S
Dynamic^b						
Input Capacitance	C _{iss}	V _{GS} = 0 V V _{DS} = 25 V, f = 1 MHz	-	2451	3065	pF
Output Capacitance	C _{oss}		-	435	545	
Reverse Transfer Capacitance	C _{rss}		-	192	240	
Total Gate Charge ^c	Q _g	V _{GS} = 10 V V _{DS} = 30 V, I _D = 50 A	-	48	72	nC
Gate-Source Charge ^c	Q _{gs}		-	7.1	-	
Gate-Drain Charge ^c	Q _{gd}		-	13.5	-	
Gate Resistance	R _g	f = 1 MHz	0.85	1.7	2.6	Ω
Turn-On Delay Time ^c	t _{d(on)}	V _{DD} = 30 V, R _L = 0.6 Ω I _D ≅ 50 A, V _{GEN} = 10 V, R _g = 1 Ω	-	10	15	ns
Rise Time ^c	t _r		-	11	17	
Turn-Off Delay Time ^c	t _{d(off)}		-	27	41	
Fall Time ^c	t _f		-	8	12	
Source-Drain Diode Ratings and Characteristics^b						
Pulsed Current ^a	I _{SM}		-	-	200	A
Forward Voltage	V _{SD}	I _F = 20 A, V _{GS} = 0 V	-	0.82	1.5	V

Notes

- Pulse test; pulse width ≤ 300 μs, duty cycle ≤ 2 %.
- Guaranteed by design, not subject to production testing.
- Independent of operating temperature.

Stresses beyond those listed under "Absolute Maximum Ratings" may cause permanent damage to the device. These are stress ratings only, and functional operation of the device at these or any other conditions beyond those indicated in the operational sections of the specifications is not implied. Exposure to absolute maximum rating conditions for extended periods may affect device reliability.



www.vishay.com

SQD50N06-09L

Vishay Siliconix

TYPICAL CHARACTERISTICS ($T_A = 25\text{ }^\circ\text{C}$, unless otherwise noted)

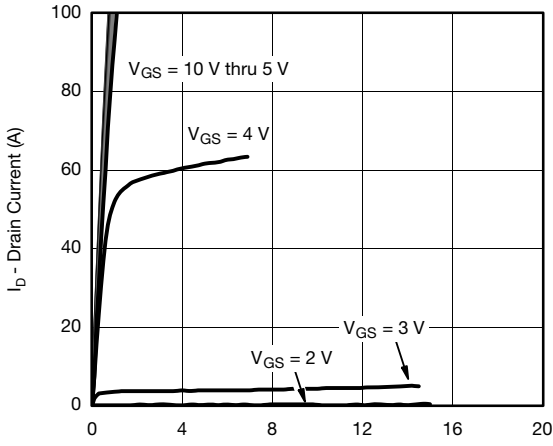

V_{DS} - Drain-to-Source Voltage (V)
Output Characteristics

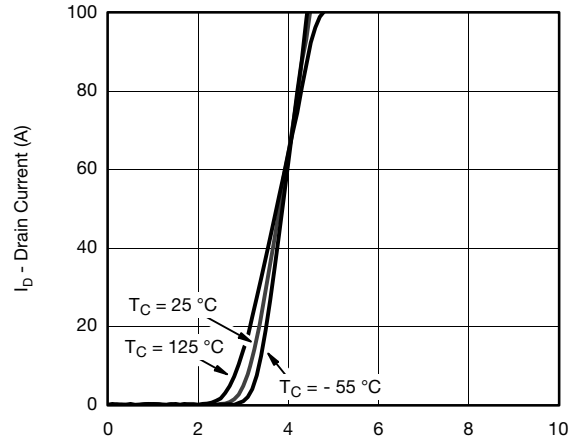

V_{GS} - Gate-to-Source Voltage (V)
Transfer Characteristics

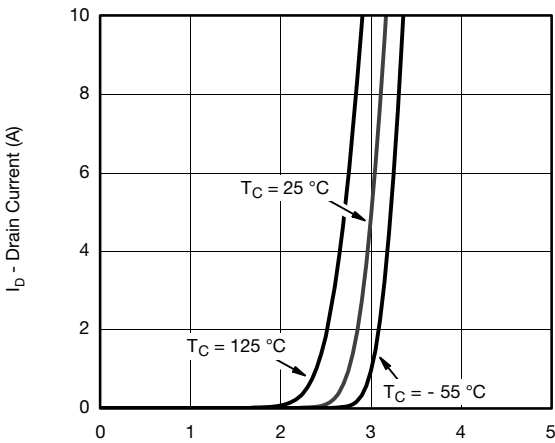

V_{GS} - Gate-to-Source Voltage (V)
Transfer Characteristics

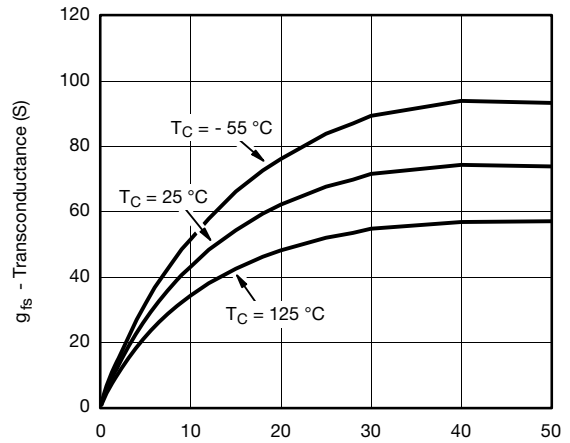

I_D - Drain Current (A)
Transconductance

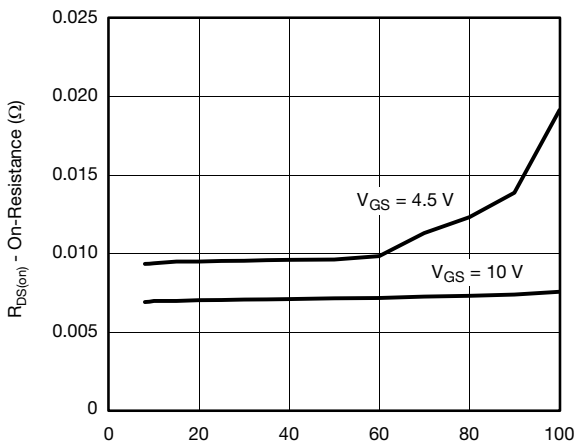

On-Resistance vs. Drain Current

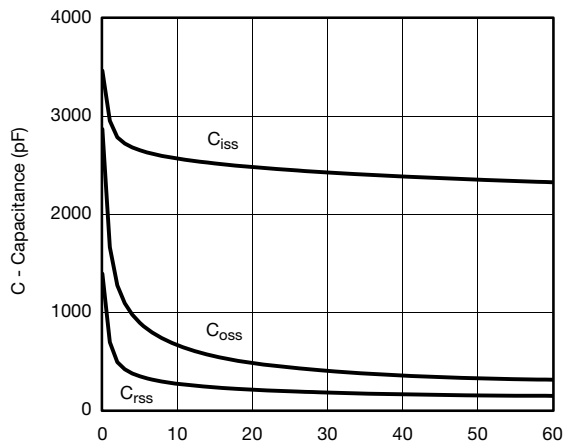

Capacitance



www.vishay.com

SQD50N06-09L

Vishay Siliconix

TYPICAL CHARACTERISTICS ($T_A = 25\text{ }^\circ\text{C}$, unless otherwise noted)

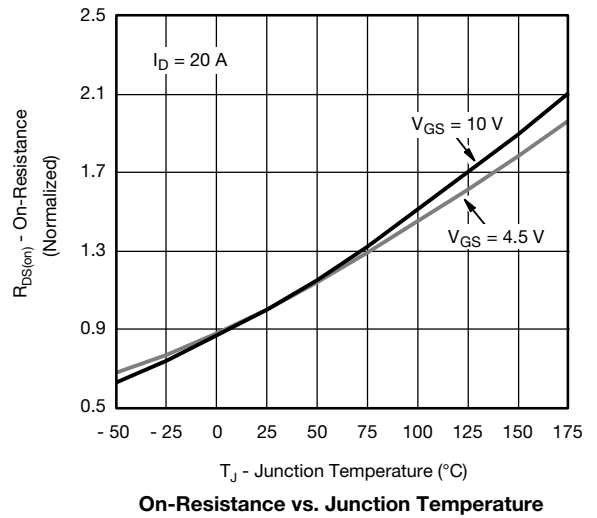
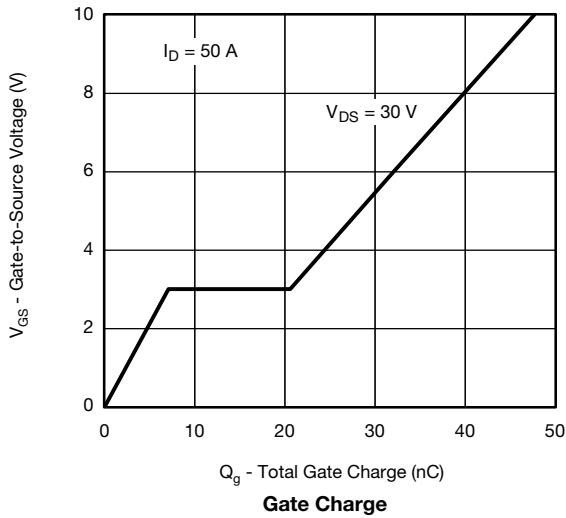

On-Resistance vs. Junction Temperature

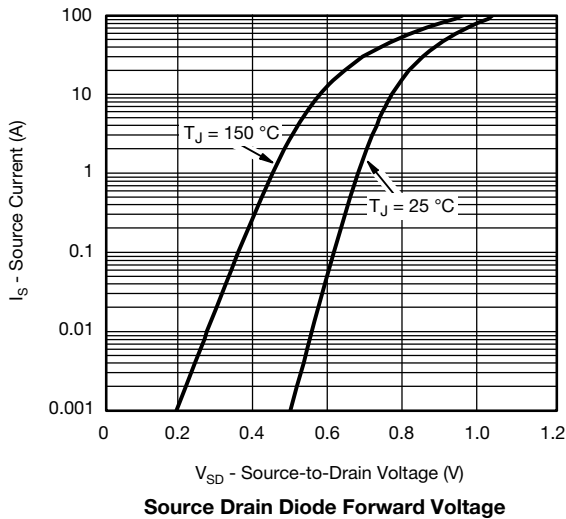

Source Drain Diode Forward Voltage

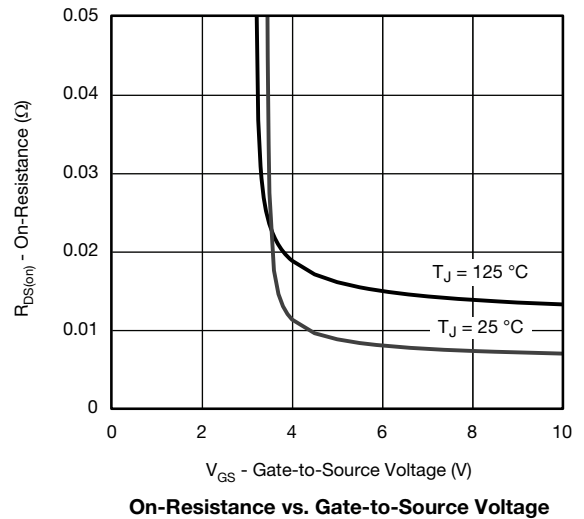

On-Resistance vs. Gate-to-Source Voltage

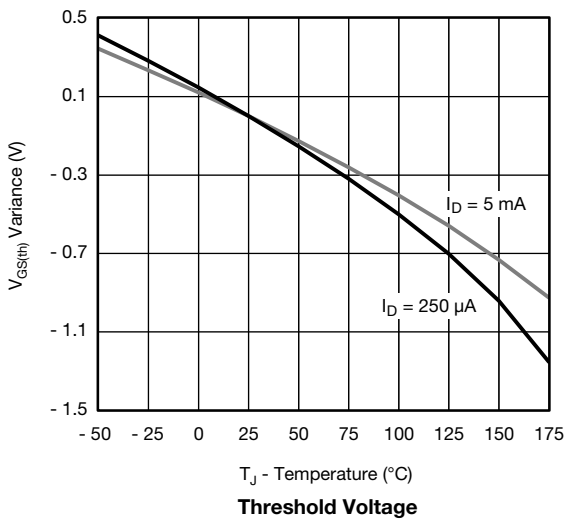

Threshold Voltage

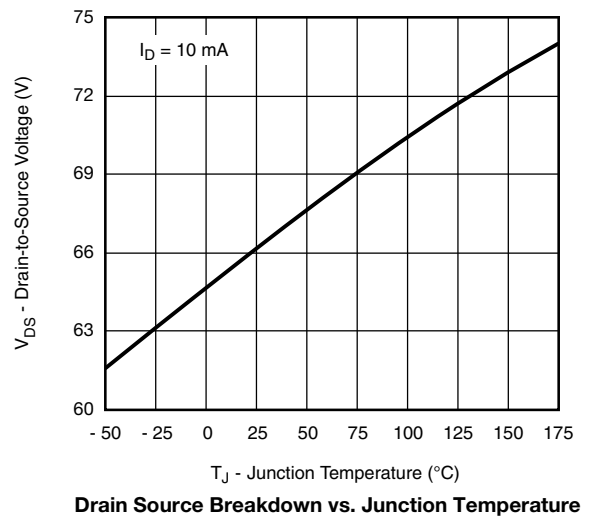

Drain Source Breakdown vs. Junction Temperature



www.vishay.com

SQD50N06-09L

Vishay Siliconix

THERMAL RATINGS ($T_A = 25\text{ }^\circ\text{C}$, unless otherwise noted)

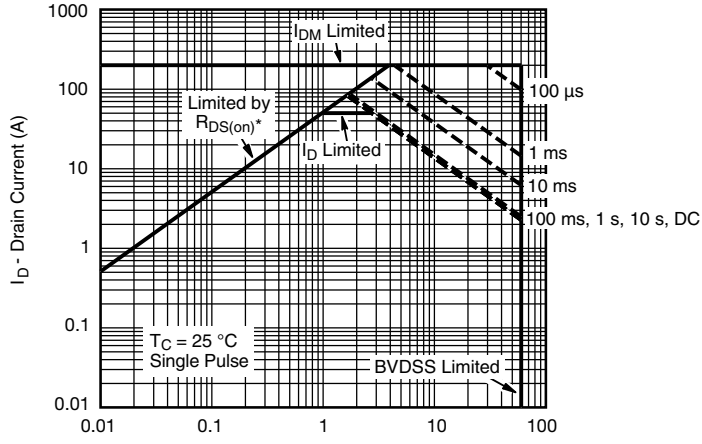

* $V_{GS} >$ minimum V_{GS} at which $R_{DS(on)}$ is specified

Safe Operating Area

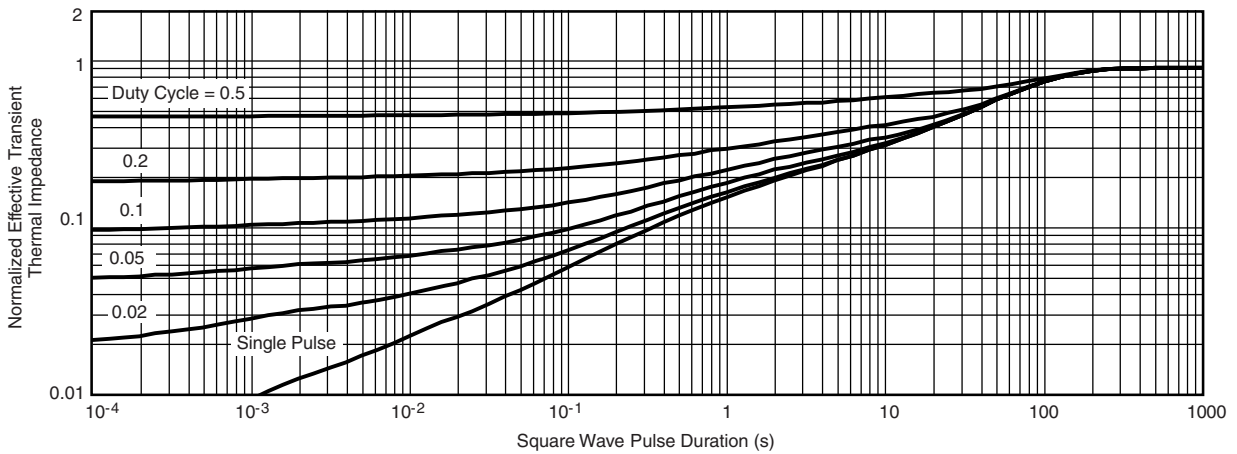

Normalized Thermal Transient Impedance, Junction-to-Ambient



www.vishay.com

SQD50N06-09L

Vishay Siliconix

THERMAL RATINGS ($T_A = 25\text{ }^\circ\text{C}$, unless otherwise noted)

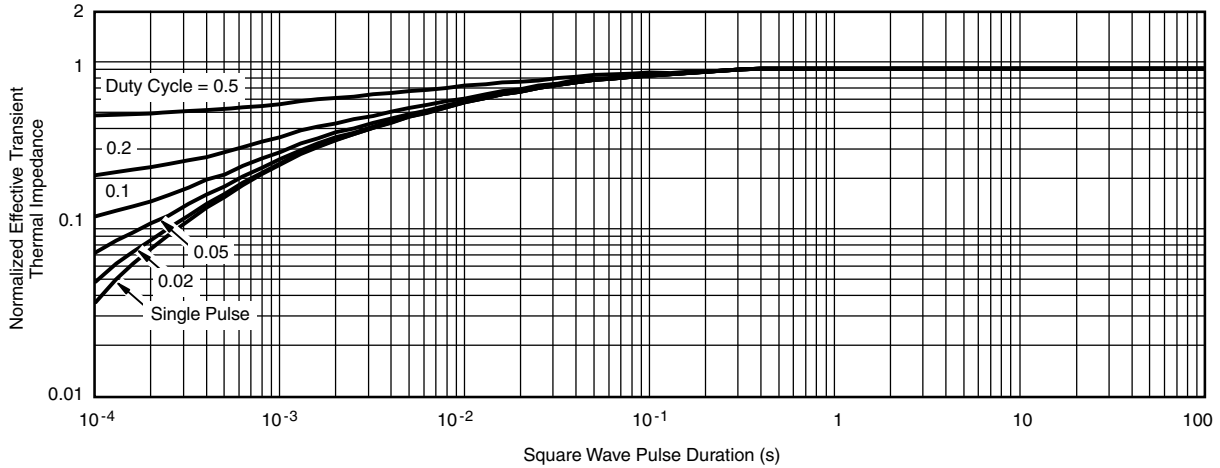

Normalized Thermal Transient Impedance, Junction-to-Case

Note

- The characteristics shown in the two graphs
 - Normalized Transient Thermal Impedance Junction-to-Ambient ($25\text{ }^\circ\text{C}$)
 - Normalized Transient Thermal Impedance Junction-to-Case ($25\text{ }^\circ\text{C}$)
 are given for general guidelines only to enable the user to get a "ball park" indication of part capabilities. The data are extracted from single pulse transient thermal impedance characteristics which are developed from empirical measurements. The latter is valid for the part mounted on printed circuit board - FR4, size 1" x 1" x 0.062", double sided with 2 oz. copper, 100 % on both sides. The part capabilities can widely vary depending on actual application parameters and operating conditions.

Vishay Siliconix maintains worldwide manufacturing capability. Products may be manufactured at one of several qualified locations. Reliability data for Silicon Technology and Package Reliability represent a composite of all qualified locations. For related documents such as package/tape drawings, part marking, and reliability data, see www.vishay.com/ppg?68901.



www.vishay.com

Ordering Information

Vishay Siliconix

DPAK / TO-252 and Reverse DPAK

Ordering codes for the SQ rugged series power MOSFETs in the DPAK / TO-252 and Reverse DPAK packages:

DATASHEET PART NUMBER	OLD ORDERING CODE ^a	NEW ORDERING CODE
SQD07N25-350H	SQD07N25-350H-GE3	SQD07N25-350H_GE3
SQD100N02-3m5L	-	SQD100N02-3m5L_GE3
SQD100N03-3m2L	SQD100N03-3M2L-GE3	SQD100N03-3M2L_GE3
SQD100N03-3m4	SQD100N03-3M4-GE3	SQD100N03-3M4_GE3
SQD100N04-3m6	SQD100N04-3M6-GE3	SQD100N04-3M6_GE3
SQD100N04-3m6L	SQD100N04-3M6L-GE3	SQD100N04-3M6L_GE3
SQD10N30-330H	SQD10N30-330H-GE3	SQD10N30-330H_GE3
SQD15N06-42L	SQD15N06-42L-GE3	SQD15N06-42L_GE3
SQD19P06-60L	SQD19P06-60L-GE3	SQD19P06-60L_GE3
SQD23N06-31L	SQD23N06-31L-GE3	SQD23N06-31L_GE3
SQD25N06-22L	SQD25N06-22L-GE3	SQD25N06-22L_GE3
SQD25N15-52	SQD25N15-52-GE3	SQD25N15-52_GE3
SQD30N05-20L	SQD30N05-20L-GE3	SQD30N05-20L_GE3
SQD40N06-14L	SQD40N06-14L-GE3	SQD40N06-14L_GE3
SQD40N10-25	SQD40N10-25-GE3	SQD40N10-25_GE3
SQD40P10-40L	SQD40P10-40L-GE3	SQD40P10-40L_GE3
SQD45P03-12	SQD45P03-12-GE3	SQD45P03-12_GE3
SQD50N04-5m6	SQD50N04-5M6-GE3	SQD50N04-5M6_GE3
SQD50N04-5m6L	-	SQD50N04-5m6L_GE3
SQD50N05-11L	SQD50N05-11L-GE3	SQD50N05-11L_GE3
SQD50N06-09L	SQD50N06-09L-GE3	SQD50N06-09L_GE3
SQD50N10-8m9L	SQD50N10-8M9L-GE3	SQD50N10-8M9L_GE3
SQD50P03-07	SQD50P03-07-GE3	SQD50P03-07_GE3
SQD50P04-13L	SQD50P04-13L-GE3	SQD50P04-13L_GE3
SQD50P04-09L	SQD50P04-09L-GE3	SQD50P04-09L_GE3
SQD50P06-15L	SQD50P06-15L-GE3	SQD50P06-15L_GE3
SQD50P08-25L	SQD50P08-25L-GE3	SQD50P08-25L_GE3
SQD50P08-28	SQD50P08-28-GE3	SQD50P08-28_GE3
SQD70140EL	-	SQD70140EL_GE3
SQD90P04-9m4L	SQD90P04-9M4L-GE3	SQD90P04-9M4L_GE3
SQD97N06-6m3L	SQD97N06-6M3L-GE3	SQD97N06-6M3L_GE3
SQR40N10-25	SQR40N10-25-GE3	SQR40N10-25_GE3
SQR50N04-3m8	SQR50N04-3M8-GE3	SQR50N04-3M8_GE3

Note

a. Old ordering code is obsolete and no longer valid for new orders



www.vishay.com

Package Information

Vishay Siliconix

TO-252AA Case Outline

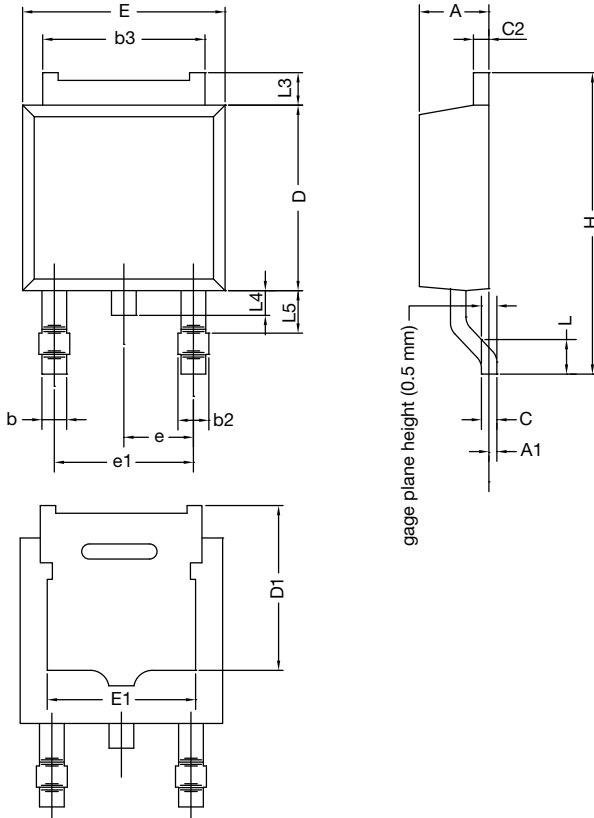

DIM.	MILLIMETERS		INCHES	
	MIN.	MAX.	MIN.	MAX.
A	2.18	2.38	0.086	0.094
A1	-	0.127	-	0.005
b	0.64	0.88	0.025	0.035
b2	0.76	1.14	0.030	0.045
b3	4.95	5.46	0.195	0.215
C	0.46	0.61	0.018	0.024
C2	0.46	0.89	0.018	0.035
D	5.97	6.22	0.235	0.245
D1	4.10	-	0.161	-
E	6.35	6.73	0.250	0.265
E1	4.32	-	0.170	-
H	9.40	10.41	0.370	0.410
e	2.28 BSC		0.090 BSC	
e1	4.56 BSC		0.180 BSC	
L	1.40	1.78	0.055	0.070
L3	0.89	1.27	0.035	0.050
L4	-	1.02	-	0.040
L5	1.01	1.52	0.040	0.060

ECN: T13-0592-Rev. A, 02-Sep-13
 DWG: 6019

Note

- Dimension L3 is for reference only.



Application Note 826

Vishay Siliconix

RECOMMENDED MINIMUM PADS FOR DPAK (TO-252)

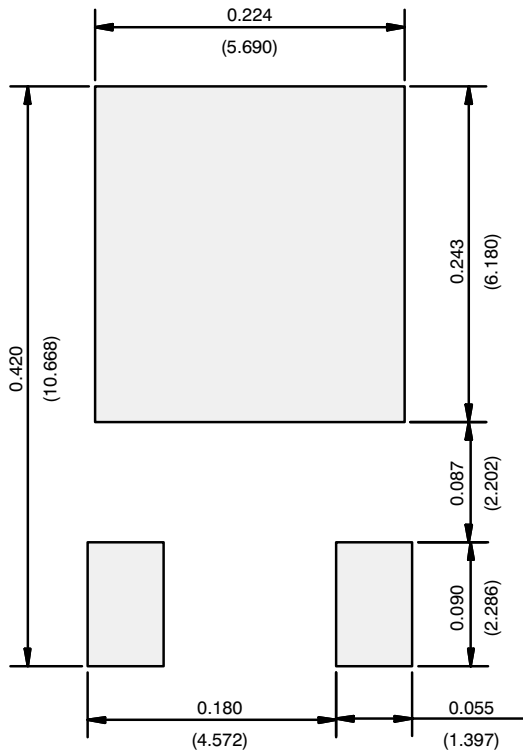

Recommended Minimum Pads
 Dimensions in Inches/(mm)

[Return to Index](#)



Disclaimer

ALL PRODUCT, PRODUCT SPECIFICATIONS AND DATA ARE SUBJECT TO CHANGE WITHOUT NOTICE TO IMPROVE RELIABILITY, FUNCTION OR DESIGN OR OTHERWISE.

Vishay Intertechnology, Inc., its affiliates, agents, and employees, and all persons acting on its or their behalf (collectively, "Vishay"), disclaim any and all liability for any errors, inaccuracies or incompleteness contained in any datasheet or in any other disclosure relating to any product.

Vishay makes no warranty, representation or guarantee regarding the suitability of the products for any particular purpose or the continuing production of any product. To the maximum extent permitted by applicable law, Vishay disclaims (i) any and all liability arising out of the application or use of any product, (ii) any and all liability, including without limitation special, consequential or incidental damages, and (iii) any and all implied warranties, including warranties of fitness for particular purpose, non-infringement and merchantability.

Statements regarding the suitability of products for certain types of applications are based on Vishay's knowledge of typical requirements that are often placed on Vishay products in generic applications. Such statements are not binding statements about the suitability of products for a particular application. It is the customer's responsibility to validate that a particular product with the properties described in the product specification is suitable for use in a particular application. Parameters provided in datasheets and / or specifications may vary in different applications and performance may vary over time. All operating parameters, including typical parameters, must be validated for each customer application by the customer's technical experts. Product specifications do not expand or otherwise modify Vishay's terms and conditions of purchase, including but not limited to the warranty expressed therein.

Except as expressly indicated in writing, Vishay products are not designed for use in medical, life-saving, or life-sustaining applications or for any other application in which the failure of the Vishay product could result in personal injury or death. Customers using or selling Vishay products not expressly indicated for use in such applications do so at their own risk. Please contact authorized Vishay personnel to obtain written terms and conditions regarding products designed for such applications.

No license, express or implied, by estoppel or otherwise, to any intellectual property rights is granted by this document or by any conduct of Vishay. Product names and markings noted herein may be trademarks of their respective owners.