

Excellent Integrated System Limited

Stocking Distributor

Click to view price, real time Inventory, Delivery & Lifecycle Information:

[BUD Industries, Inc.](#)
[JB-3957](#)

For any questions, you can email us directly:

sales@integrated-circuit.com

PART NAME	JUNCTION BOX	PART No.	JB-3957	REVISION DATE	7-18-11
-----------	--------------	----------	---------	---------------	---------



MATERIAL - 16 GA. [1.5mm] STEEL
FINISH - SMOOTH GRAY POWDERCOAT

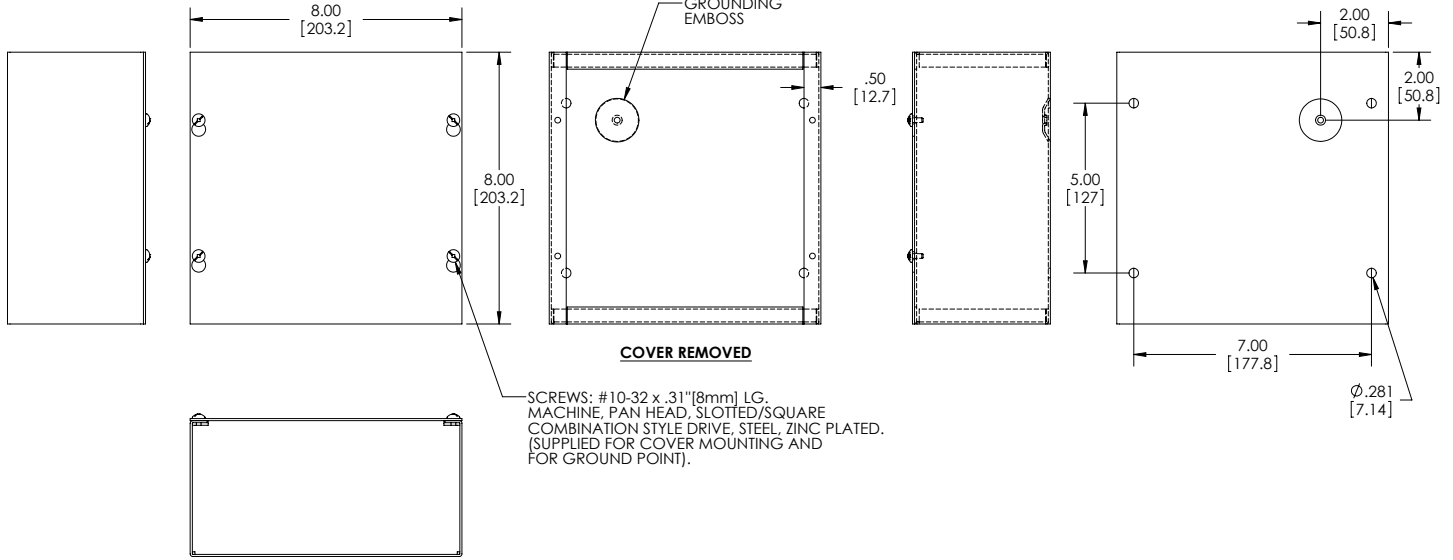
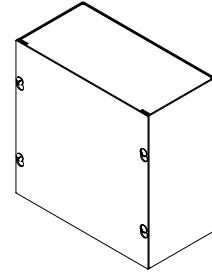

COVER REMOVED

SCREWS: #10-32 x .31" [8mm] LG. MACHINE, PAN HEAD, SLOTTED/SQUARE COMBINATION STYLE DRIVE, STEEL, ZINC PLATED. (SUPPLIED FOR COVER MOUNTING AND FOR GROUND POINT).