

Excellent Integrated System Limited

Stocking Distributor

Click to view price, real time Inventory, Delivery & Lifecycle Information:

[Phoenix Contact](#)
[1730654](#)

For any questions, you can email us directly:

sales@integrated-circuit.com



Extract from the online catalog

EMKDS 2,5/ 6-5,08

Order No.: 1730654

The illustration shows a 12-position version

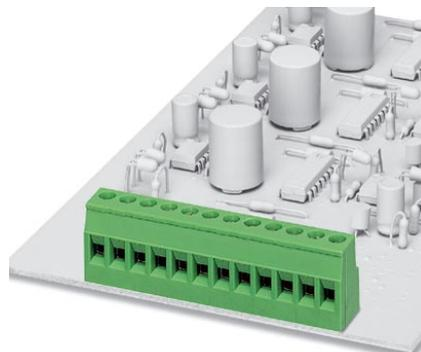

<http://eshop.phoenixcontact.de/phoenix/treeViewClick.do?UID=1730654>

PC terminal block, Nominal current: 12 A, Nom. voltage: 250 V, Pitch: 5.08 mm, Number of positions: 6, Type of connection: Screw connection, Assembly: Press-in, Conductor/PCB connection direction: 0 °, Color: green

Commercial data	
EAN	4017918116026
Pack	50 pcs.
Customs tariff	85369010
Weight/Piece	0.01259 KG
Catalog page information	Page 19 (CC-2005)

Product notes

WEEE/RoHS-compliant since:
01/01/2003



<http://www.download.phoenixcontact.com>
Please note that the data given here has been taken from the online catalog. For comprehensive information and data, please refer to the user documentation. The General Terms and Conditions of Use apply to Internet downloads.

Technical data

Dimensions / positions	
Pitch	5.08 mm
Number of positions	6
Pin dimensions	1,4 mm
Hole diameter	1.45 mm

EMKDS 2,5/ 6-5,08 Order No.: 1730654

<http://eshop.phoenixcontact.de/phoenix/treeViewClick.do?UID=1730654>

Screw thread	M3
Tightening torque, min	0.5 Nm
Tightening torque max	0.6 Nm

Technical data

Insulating material group	I
Rated surge voltage (III/3)	2.5 kV
Rated surge voltage (III/2)	2.5 kV
Rated surge voltage (II/2)	2.5 kV
Rated voltage (III/2)	320 V
Rated voltage (II/2)	630 V
Connection in acc. with standard	EN-VDE
Nominal current I_N	12 A
Nominal voltage U_N	250 V
Nominal cross section	2.5 mm ²
Maximum load current	12 A
Insulating material	PA
Inflammability class acc. to UL 94	V0
Internal cylindrical gage	A3
Stripping length	8 mm

Connection data

Conductor cross section solid min.	0.14 mm ²
Conductor cross section solid max.	2.5 mm ²
Conductor cross section stranded min.	0.14 mm ²
Conductor cross section stranded max.	2.5 mm ²
Conductor cross section stranded, with ferrule without plastic sleeve min.	0.25 mm ²
Conductor cross section stranded, with ferrule without plastic sleeve max.	2.5 mm ²
Conductor cross section stranded, with ferrule with plastic sleeve min.	0.25 mm ²
Conductor cross section stranded, with ferrule with plastic sleeve max.	1.5 mm ²
Conductor cross section AWG/kcmil min.	26
Conductor cross section AWG/kcmil max	16
2 conductors with same cross section, solid min.	0.14 mm ²
2 conductors with same cross section, solid max.	0.75 mm ²

EMKDS 2,5/ 6-5,08 Order No.: 1730654

<http://eshop.phoenixcontact.de/phoenix/treeViewClick.do?UID=1730654>

2 conductors with same cross section, stranded min.	0.14 mm ²
2 conductors with same cross section, stranded max.	0.75 mm ²
2 conductors with same cross section, stranded, ferrules without plastic sleeve, min.	0.25 mm ²
2 conductors with same cross section, stranded, ferrules without plastic sleeve, max.	0.5 mm ²
2 conductors with same cross section, stranded, TWIN ferrules with plastic sleeve, min.	0.5 mm ²
2 conductors with same cross section, stranded, TWIN ferrules with plastic sleeve, max.	1.5 mm ²

Certificates / Approvals



Certification

CSA, CUL, GOST, UL

CSA

Nominal voltage U _N	300 V
Nominal current I _N	10 A
AWG/kcmil	28-12

CUL

Nominal voltage U _N	300 V
Nominal current I _N	10 A
AWG/kcmil	30-12

UL

Nominal voltage U _N	300 V
Nominal current I _N	10 A
AWG/kcmil	30-12

EMKDS 2,5/ 6-5,08 Order No.: 1730654

<http://eshop.phoenixcontact.de/phoenix/treeViewClick.do?UID=1730654>

Accessories

Item	Designation	Description
Marking		
0804293	SK 5,08/3,8:FORTL.ZAHLEN	Marker card, printed horizontally, self-adhesive, 12 identical decades marked 1-10, 11-20 etc. up to 91-(99)100, sufficient for 120 terminal blocks
Tools		
1205053	SZS 0,6X3,5	Screwdriver, bladed, matches all screw terminal blocks up to 4.0 mm ² connection cross section, blade: 0.6 x 3.5 mm, without VDE approval

Diagrams/Drawings

Drilling plan/solder pad geometry

Bore hole in the basic material,

mostly epoxy glass fabric FR4 or EP-GC

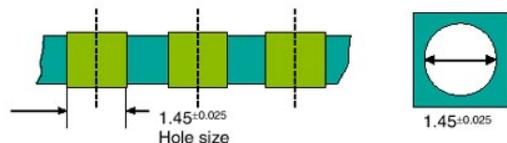

Bore hole with Cu ferrule

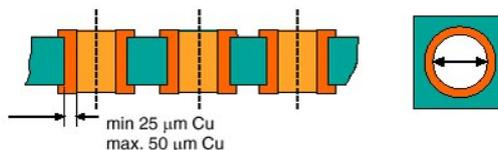

Plated-through bore hole with Sn/SnPb

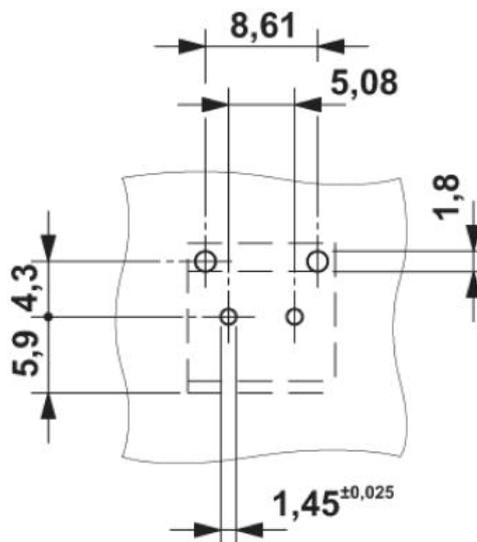
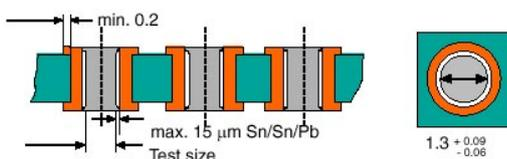

EMKDS 2,5/ 6-5,08 Order No.: 1730654

<http://eshop.phoenixcontact.de/phoenix/treeViewClick.do?UID=1730654>

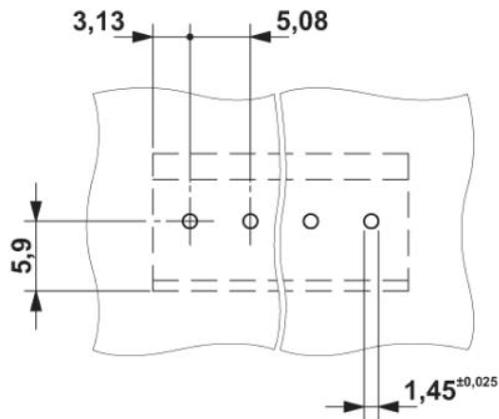

Dimensioned drawing

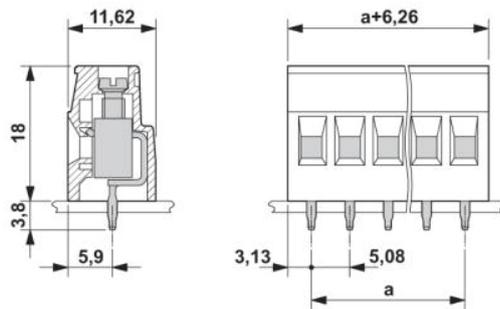

EMKDS 2,5/ 6-5,08 Order No.: 1730654

<http://eshop.phoenixcontact.de/phoenix/treeViewClick.do?UID=1730654>

Address

PHOENIX CONTACT Deutschland GmbH
Flachsmarktstr. 8
32825 Blomberg, Germany
Phone +49 5235 3 12000
Fax +49 5235 3 41200
<http://www.phoenixcontact.de>



© 2010 Phoenix Contact
Technical modifications reserved;