

## Excellent Integrated System Limited

Stocking Distributor

Click to view price, real time Inventory, Delivery & Lifecycle Information:

[Everlight Electronics Co Ltd](#)  
[383-2UYC/S530-A4](#)

For any questions, you can email us directly:  
[sales@integrated-circuit.com](mailto:sales@integrated-circuit.com)



## Technical Data Sheet

### 383-2UYC/S530-AX

#### Features

- Popular T-1 3/4package.
- High efficiency.
- General purpose leads.
- Selected minimum intensities.
- Available on tape and reel.
- Pb free

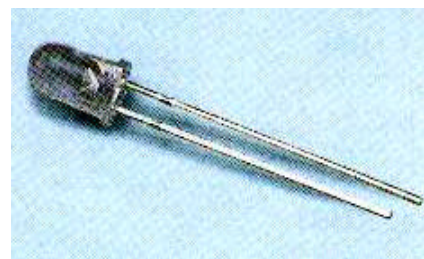

#### Descriptions

- The series is specially designed for applications requiring higher brightness.
- The LED lamps are available with different colors, intensities, epoxy colors, etc.
- Superior performance in outdoor environment

#### Applications

- Status indicators.
- Commercial use.
- Advertising Signs.
- Back lighting.

#### Device Selection Guide

LED Part No.	Chip		Lens Color
	Material	Emitted Color	
383-2UYC/S530-A3	AlGaInP	Super Yellow	Water Clear
383-2UYC/S530-A4			
383-2UYC/S530-A5			



**383-2UYC/S530-AX**

**Package Dimensions**

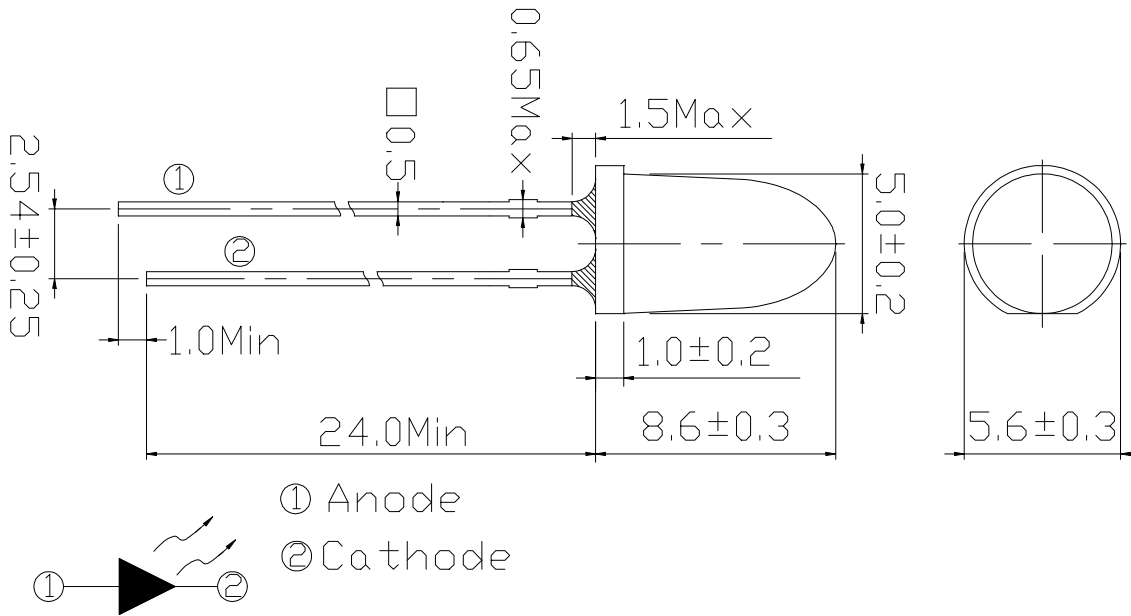

**Notes:**

- \* Other dimensions are in millimeters, tolerance is 0.25mm except being specified.
- \* Protruded resin under flange is 1.5mm Max LED.
- \* Bare copper alloy is exposed at tie-bar portion after cutting.

**Absolute Maximum Rating (T<sub>a</sub>=25 )**

Parameter	Symbol	Absolute Maximum Rating	Unit
Forward Current	I <sub>F</sub>	25	mA
Pulse Forward Current (Duty 1/10@ 1KHz)	I <sub>FP</sub>	60	mA
Operating Temperature	T <sub>opr</sub>	-40 ~ +85	
Storage Temperature	T <sub>stg</sub>	-40 ~ +100	
Electrostatic Discharge	ESD	2000	V
Soldering Temperature	T <sub>sol</sub>	260 ±5	
Power Dissipation	P <sub>d</sub>	60	mW
Reverse Voltage	V <sub>R</sub>	5	V

Notes: Soldering time 5 seconds.



### 383-2UYC/S530-AX

#### Electro-Optical Characteristics (T<sub>a</sub>=25 )

Parameter	Symbol	*Chip Rank	Min.	Typ.	Max.	Unit	Condition
Luminous Intensity	I <sub>V</sub>	A3	3200	5000	--	mcd	I <sub>F</sub> =20mA
		A4	4000	6300	--		
		A5	5000	8000	--		
Viewing Angle	2 1/2	--	--	6	--	deg	
Peak Wavelength	p	--	--	591	--	nm	
Dominant Wavelength	d	--	--	589	--		
Spectrum Half width		--	--	15	--		
Forward Voltage	V <sub>F</sub>	--	--	2.0	2.4	V	
Reverse Current	I <sub>R</sub>	--	--	--	10	μA	V <sub>R</sub> =5V

\*383-2UYC/S530-AX

↑  
 Chip Rank



**383-2UYC/S530-AX**

**Typical Electro-Optical Characteristics Curves**

**Relative Intensity vs. Wavelength**

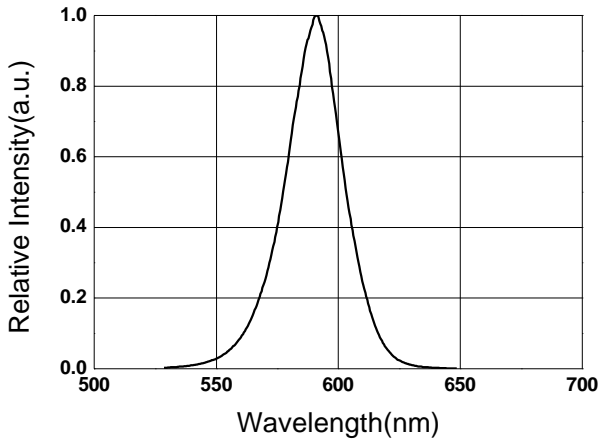

**Forward Current vs. Forward Voltage**

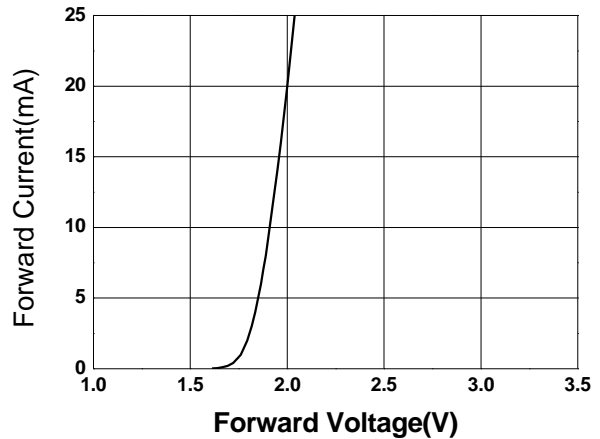

**Relative Intensity vs. Ambient Temp**

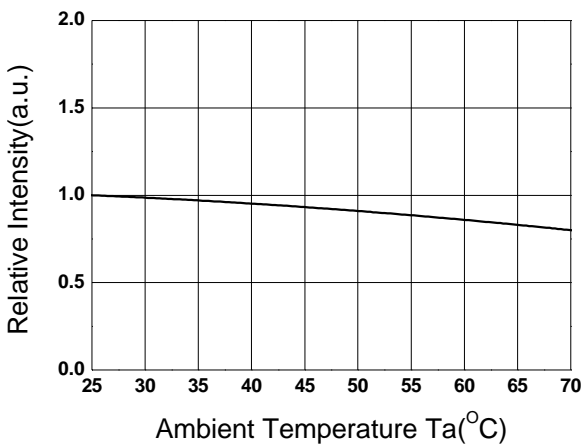

**Forward Current vs. Relative Intensity**

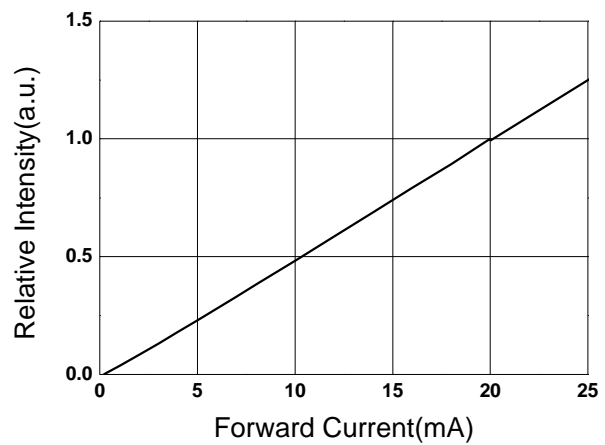

**Forward Current vs. Ambient Temp.**

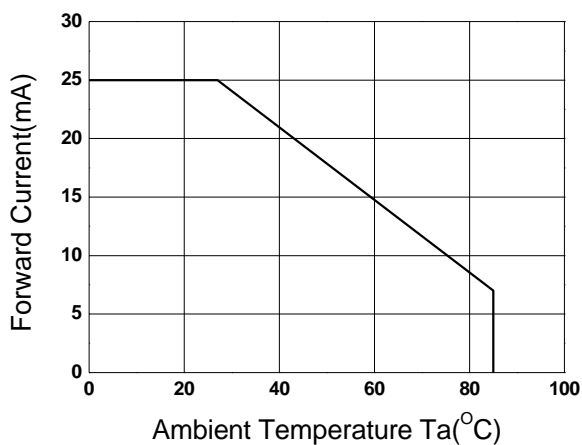

**Radiation Characteristics**

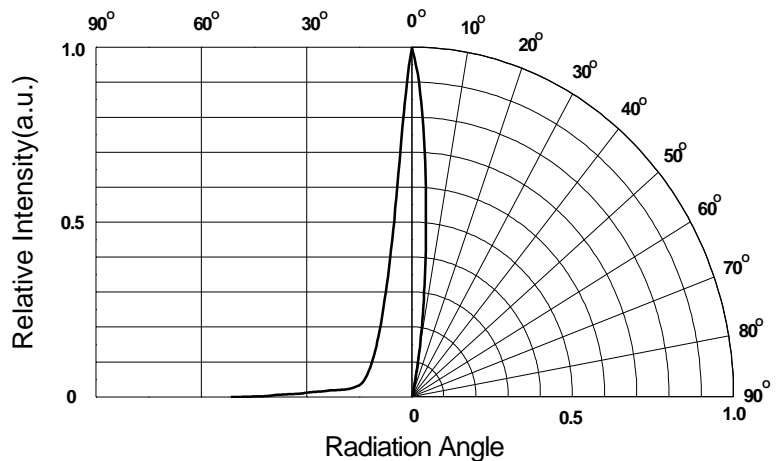



**383-2UYC/S530-AX**

**Packing Quantity Specification**

- 1.500PCS/1Bag , 5Bags/1Box
- 2.10Boxes/1Carton

**Label Form Specification**

<div style="border: 1px solid black; width: 150px; margin: 0 auto; padding: 2px;">EVERLIGHT</div>	
CPN:	
P/N:	
383-2UYC/S530-AX	
QTY :	CAT:
LOT NO :	REF:
MADE IN TAIWAN	

CPN: Customer's Production Number  
 P/N : Production Number  
 383-2UYC/S530-AX:Production name  
 QTY: Packing Quantity  
 CAT: Ranks of Luminous and Forward Voltage  
 HUE: Ranks of Dominant Wavelength  
 REF: Reference  
 LOT No: Lot Number  
 MADE IN TAIWAN: Production Place

**Notes**

1. Above specification may be changed without notice. EVERLIGHT will reserve authority on material change for above specification.
2. When using this product, please observe the absolute maximum ratings and the instructions for using outlined in these specification sheets. EVERLIGHT assumes no responsibility for any damage resulting from use of the product which does not comply with the absolute maximum ratings and the instructions included in these specification sheets.
3. These specification sheets include materials protected under copyright of EVERLIGHT corporation. Please don't reproduce or cause anyone to reproduce them without EVERLIGHT's consent.

<b>EVERLIGHT ELECTRONICS CO., LTD.</b> Office: No 25, Lane 76, Sec 3, Chung Yang Rd, Tucheng, Taipei 236, Taiwan, R.O.C	Tel: 886-2-2267-2000, 2267-9936 Fax: 886-2267-6244, 2267-6189, 2267-6306 <a href="http://www.everlight.com">http://www.everlight.com</a>
---	--