

Excellent Integrated System Limited

Stocking Distributor

Click to view price, real time Inventory, Delivery & Lifecycle Information:

[Everlight Electronics Co Ltd](#)
[7343-2SURC/S530-A5](#)

For any questions, you can email us directly:

sales@integrated-circuit.com



EVERLIGHT ELECTRONICS CO.,LTD.

Technical Data Sheet

Light Emitting Diode (5 mm Round LED,T-1 3/4)

7343-2SURC/S530-AX

Features

- Popular T-1 3/4 diameter package.
- Choice of various viewing angles.
- Reliable and robust.
- Pb free
- The product itself will remain within RoHS compliant version.



Descriptions

- The series is specially designed for applications requiring higher brightness.
- The LED lamps are available with different colors,intensities,epoxy colors, etc.

Applications

- TV set.
- Monitor.
- Telephone.
- Computer.

Device Selection Guide

Chip		Lens Color
Material	Emitted Color	
AlGaInP	Hyper Red	Water Clear



EVERLIGHT ELECTRONICS CO.,LTD.

Technical Data Sheet

Light Emitting Diode (5 mm Round LED,T-1 3/4)

7343-2SURC/S530-AX

Package Dimensions

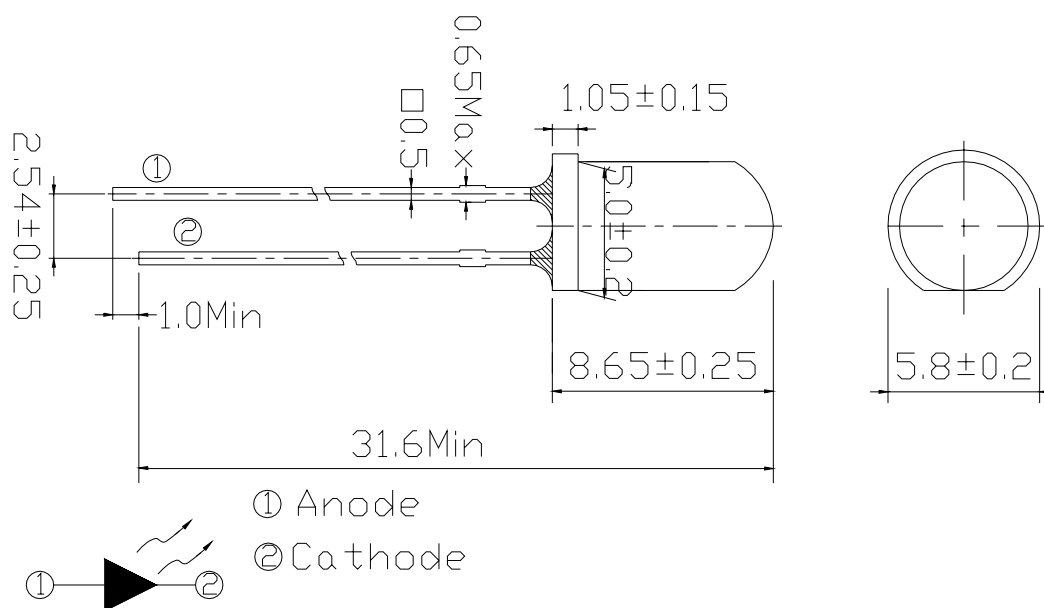

Notes:

- All dimensions are in millimeters , tolerance is 0.25mm except being specified.
- Lead spacing is measured where the lead emerges from the package.
- Protruded resin under flange is 1.5mm Max LED.

Absolute Maximum Ratings (Ta=25°C)

Parameter	Symbol	Rating	Units
Forward Current	I _F	25	mA
Pulse Forward Current ^{*1}	I _{FP}	60	mA
Operating Temperature	T _{opr}	-40 ~ +120	°C
Storage Temperature	T _{stg}	-40 ~ +120	°C
Electrostatic Discharge	ESD	2000	V
Soldering Temperature ^{*2}	T _{sol}	260 ±5	°C
Power Dissipation	P _d	60	mW
Reverse Voltage	V _R	5	V



EVERLIGHT ELECTRONICS CO.,LTD.

Technical Data Sheet

Light Emitting Diode (5 mm Round LED,T-1 3/4)

7343-2SURC/S530-AX

Notes: *1: I_{FP} Conditions--Pulse Width ≤ 10 msec and Duty $\leq 1/10$.

*2:Soldering time ≤ 5 seconds.

Electro-Optical Characteristics (Ta=25°C)

Parameter	Symbol	Condition	Chip Rank	Min.	Typ.	Max.	Units
Forward Voltage	V_F	$I_F=20$ mA	--	--	2.0	2.4	V
Reverse Current	I_R	$V_R=5$ V	--	--	--	10	μ A
Luminous Intensity	I_V	$I_F=20$ mA	A3	500	800	--	mcd
			A4	630	1000	--	
			A5	800	1250	--	
Viewing Angle	2θ 1/2	$I_F=20$ mA	--	--	25	--	deg
Peak Wavelength	λ_p	$I_F=20$ mA	--	--	632	--	nm
Dominant Wavelength	λ_d	$I_F=20$ mA	--	--	624	--	nm
Spectrum Radiation Bandwidth	$\Delta \lambda$	$I_F=20$ mA	--	--	20	--	nm

***7343-2SURC/S530-AX**

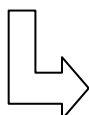

Chip Rank



EVERLIGHT ELECTRONICS CO.,LTD.

Technical Data Sheet

Light Emitting Diode (5 mm Round LED,T-1 3/4)

7343-2SURC/S530-AX

Typical Electro-Optical Characteristics Curves

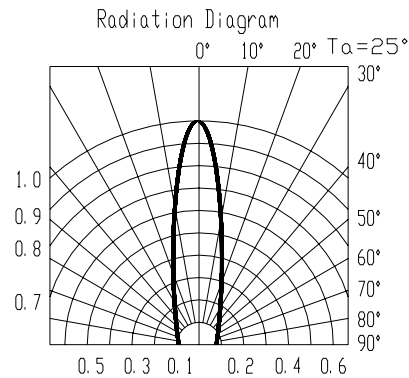
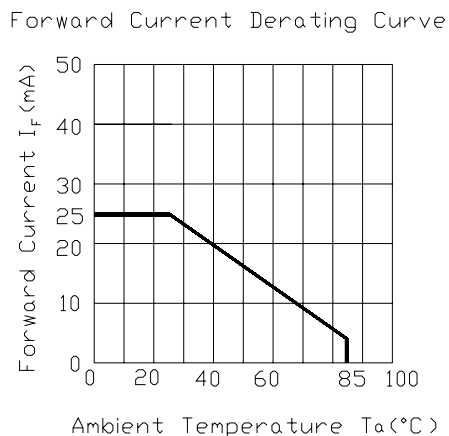
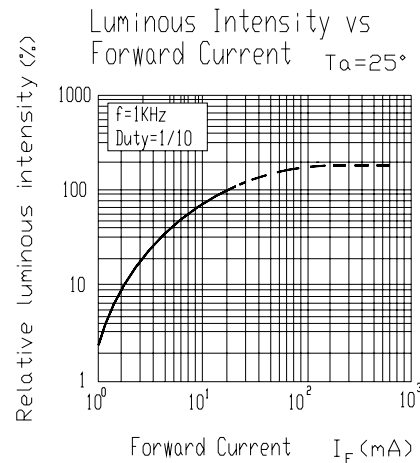
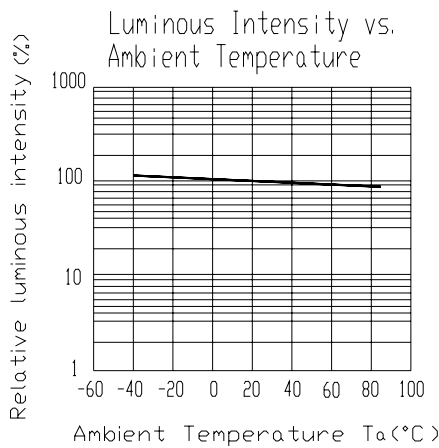
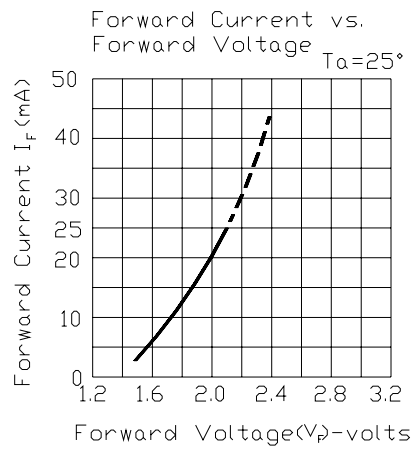
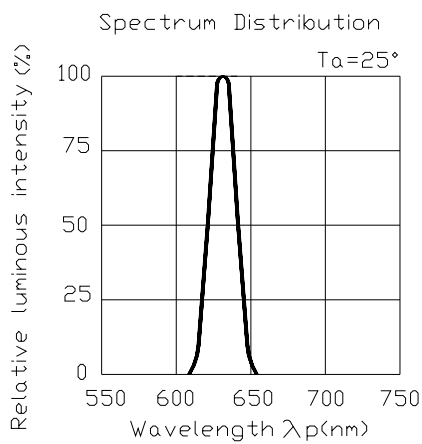



EVERLIGHT ELECTRONICS CO.,LTD.

Technical Data Sheet

Light Emitting Diode (5 mm Round LED,T-1 3/4)





7343-2SURC/S530-AX

Packing Quantity Specification

1.500PCS/1Bag , 5Bags/1Box

2.10Boxes/1Carton

Label Form Specification

	
CPN:	
P/N:	 RoHS
7343-2SURC/S530-AX	
QTY :	CAT:
	HUE:
LOT NO :	REF:
	
MADE IN TAIWAN	

CPN: Customer's Production Number

P/N : Production Number

QTY: Packing Quantity

AT: Ranks

HUE: Peak Wavelength

REF: Reference

LOT No: Lot Number

MADE IN TAIWAN: Production Place

Notes

1. Above specification may be changed without notice. EVERLIGHT will reserve authority on material change for above specification.
2. When using this product, please observe the absolute maximum ratings and the instructions for using outlined in these specification sheets. EVERLIGHT assumes no responsibility for any damage resulting from use of the product which does not comply with the absolute maximum ratings and the instructions included in these specification sheets.
3. These specification sheets include materials protected under copyright of EVERLIGHT corporation. Please don't reproduce or cause anyone to reproduce them without EVERLIGHT's consent.

EVERLIGHT ELECTRONICS CO., LTD.

Office: No 25, Lane 76, Sec 3, Chung Yang Rd,
Tucheng, Taipei 236, Taiwan, R.O.C

Tel: 886-2-2267-2000, 2267-9936

Fax: 886-2267-6244, 2267-6189, 2267-6306

<http://www.everlight.com>



EVERLIGHT ELECTRONICS CO.,LTD.

Technical Data Sheet

Light Emitting Diode (5 mm Round LED,T-1 3/4)

7343-2SURC/S530-AX