

## Excellent Integrated System Limited

Stocking Distributor

Click to view price, real time Inventory, Delivery & Lifecycle Information:

[Everlight Electronics Co Ltd](#)  
[7343-2USOC/S400-A9](#)

For any questions, you can email us directly:

[sales@integrated-circuit.com](mailto:sales@integrated-circuit.com)



EVERLIGHT ELECTRONICS CO.,LTD.

**Technical Data Sheet**

**Light Emitting Diode (5 mm Round LED,T-1 3/4)**

**7343-2USOC/S400-AX**

**Features**

- Popular T-1 3/4 diameter package.
- Choice of various viewing angles.
- Reliable and robust.
- Pb free
- The product itself will remain within RoHS compliant version.



**Descriptions**

- The series is specially designed for applications requiring higher brightness.
- The LED lamps are available with different colors,intensities,epoxy colors, etc.

**Applications**

- TV set.
- Monitor.
- Telephone.
- Computer.

**Device Selection Guide**

Chip		Lens Color
Material	Emitted Color	
AlGaInP	Super Orange	Water Clear



EVERLIGHT ELECTRONICS CO.,LTD.

**Technical Data Sheet**

**Light Emitting Diode (5 mm Round LED,T-1 3/4)**

**7343-2USOC/S400-AX**

**Package Dimensions**

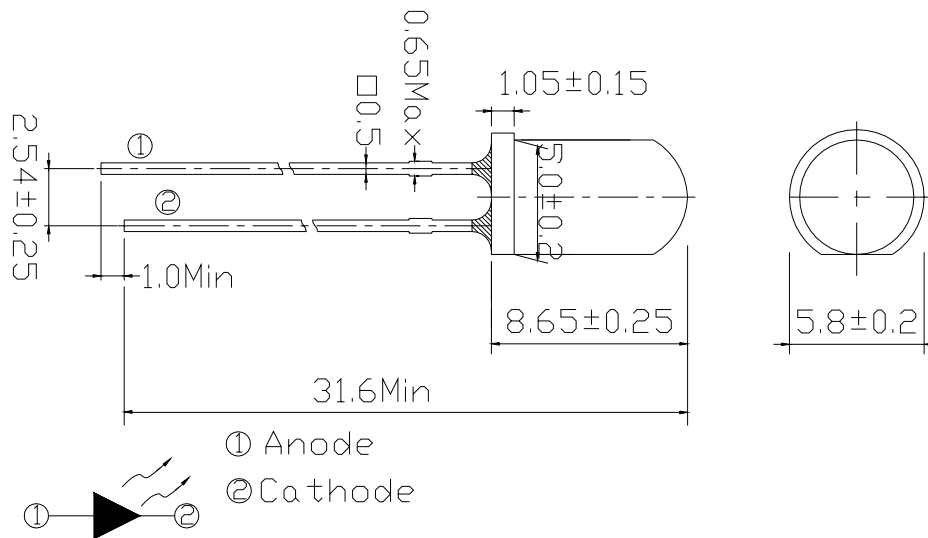

**Notes:**

- All dimensions are in millimeters, tolerance is 0.25mm except being specified.
- Lead spacing is measured where the lead emerges from the package.
- Protruded resin under flange is 1.5mm Max LED.

**Absolute Maximum Ratings (Ta=25°C)**

Parameter	Symbol	Rating	Units
Forward Current	I <sub>F</sub>	50	mA
Pulse Forward Current <sup>*1</sup>	I <sub>FP</sub>	200	mA
Operating Temperature	T <sub>opr</sub>	-40 ~ +85	°C
Storage Temperature	T <sub>stg</sub>	-40 ~ +100	°C
Electrostatic Discharge	ESD	2000	V
Soldering Temperature <sup>*2</sup>	T <sub>sol</sub>	260 ±5	°C
Power Dissipation	P <sub>d</sub>	120	mW
Reverse Voltage	V <sub>R</sub>	5	V

**Notes:** \*1:I<sub>FP</sub> Conditions--Pulse Width ≤ 10msec and Duty ≤ 1/10.

\*2:Soldering time ≤ 5 seconds.



EVERLIGHT ELECTRONICS CO.,LTD.

**Technical Data Sheet**

**Light Emitting Diode (5 mm Round LED,T-1 3/4)**

**7343-2USOC/S400-AX**

**Electro-Optical Characteristics (Ta=25°C)**

Parameter	Symbol	Condition	Chip Rank	Min.	Typ.	Max.	Units
Forward Voltage	V <sub>F</sub>	I <sub>F</sub> =20mA	--	--	2.0	2.4	V
Reverse Current	I <sub>R</sub>	V <sub>R</sub> =5V	--	--	--	10	μA
Luminous Intensity	I <sub>V</sub>	I <sub>F</sub> =20mA	A6	1000	1600	--	mcd
			A7	1250	2000	--	
			A8	1600	2500	--	
			A9	2000	3200	--	
Viewing Angle	2 θ 1/2	I <sub>F</sub> =20mA	--	--	25	--	deg
Peak Wavelength	λ <sub>p</sub>	I <sub>F</sub> =20mA	--	--	621	--	nm
Dominant Wavelength	λ <sub>d</sub>	I <sub>F</sub> =20mA	--	--	615	--	nm
Spectrum Radiation Bandwidth	Δ λ	I <sub>F</sub> =20mA	--	--	18	--	nm

**\*7343-2USOC/S400-AX**

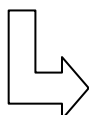

Chip Rank



**EVERLIGHT ELECTRONICS CO.,LTD.**

**Technical Data Sheet**

**Light Emitting Diode (5 mm Round LED,T-1 3/4)**

**7343-2USOC/S400-AX**

**Typical Electro-Optical Characteristics Curves**

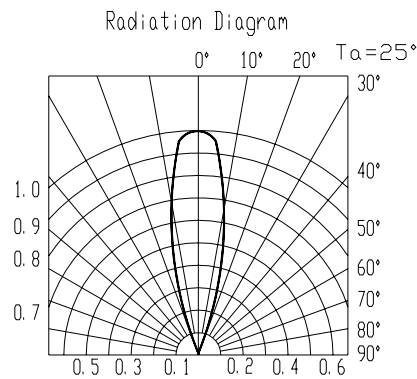
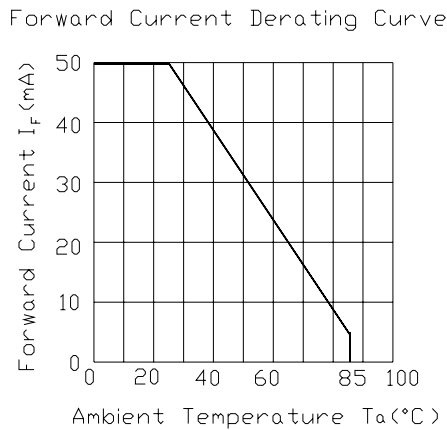
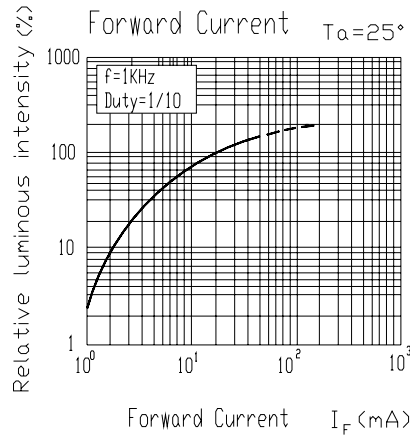
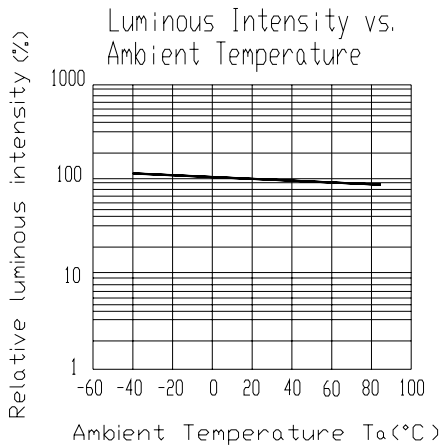
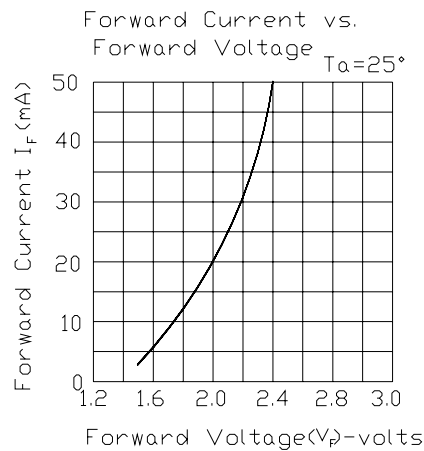
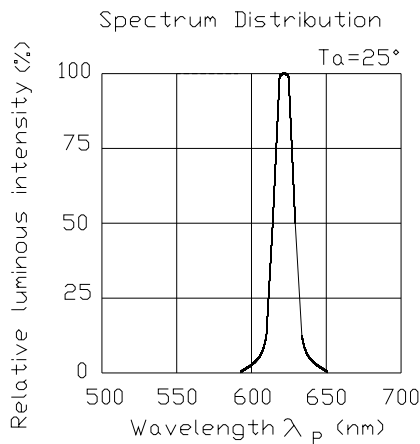





EVERLIGHT ELECTRONICS CO.,LTD.

**Technical Data Sheet**

**Light Emitting Diode (5 mm Round LED,T-1 3/4)**

**7343-2USOC/S400-AX**

**Label Form Specification**

<div style="border: 1px solid black; padding: 5px; width: fit-content; margin: 0 auto;">EVERLIGHT</div>	
CPN:	
P/N:	
	
<div style="border: 1px solid black; padding: 2px; font-size: small;">RoHS</div>	
7343USOC/S400-AX	
QTY :	CAT:
	
LOT NO :	HUE:
	
MADE IN TAIWAN	

CPN: Customer's Production Number  
 P/N : Production Number  
 QTY: Packing Quantity  
 CAT: Ranks of Luminous and Forward Voltage  
 HUE: Ranks of Dominant Wavelength  
 REF: Reference  
 LOT No: Lot Number  
 MADE IN TAIWAN: Production Place

**Notes**

1. Above specification may be changed without notice. EVERLIGHT will reserve authority on material change for above specification.
2. When using this product, please observe the absolute maximum ratings and the instructions for using outlined in these specification sheets. EVERLIGHT assumes no responsibility for any damage resulting from use of the product which does not comply with the absolute maximum ratings and the instructions included in these specification sheets.
3. These specification sheets include materials protected under copyright of EVERLIGHT corporation. Please don't reproduce or cause anyone to reproduce them without EVERLIGHT's consent.

**EVERLIGHT ELECTRONICS CO., LTD.**  
 Office: No 25, Lane 76, Sec 3, Chung Yang Rd,  
 Tucheng, Taipei 236, Taiwan, R.O.C

Tel: 886-2-2267-2000, 2267-9936  
 Fax: 886-2267-6244, 2267-6189, 2267-6306  
<http://www.everlight.com>