

Excellent Integrated System Limited

Stocking Distributor

Click to view price, real time Inventory, Delivery & Lifecycle Information:

[Phoenix Contact](#)
[2200319](#)

For any questions, you can email us directly:

sales@integrated-circuit.com



Extract from the online catalog

FKDSO 2,5/ 4-L KMGY

Order No.: 2200319



<http://eshop.phoenixcontact.de/phoenix/treeViewClick.do?UID=2200319>

PC terminal block, Nominal current: 22 A, Nom. voltage: 250 V, Pitch: 5 mm, Number of positions: 4, Connection method: Spring-cage conn., Mounting: Soldering, Conductor/PCB connection direction: 0 °, Color: light gray, Article with lateral pin exit

Commercial data	
GTIN (EAN)	 4 046356 563840
sales group	F057
Pack	50 pcs.
Customs tariff	85366990
Catalog page information	Page 145 (CC-2011)

Product notes

WEEE/RoHS-compliant since:
02/04/2010



<http://www.download.phoenixcontact.com>
 Please note that the data given here has been taken from the online catalog. For comprehensive information and data, please refer to the user documentation. The General Terms and Conditions of Use apply to Internet downloads.

Technical data

Dimensions / positions	
Length	25.9 mm
Height	26.5 mm
Pitch	5 mm

FKDSO 2,5/ 4-L KMGY Order No.: 2200319

<http://eshop.phoenixcontact.de/phoenix/treeViewClick.do?UID=2200319>

Dimension a	15 mm
Number of positions	4
Pin dimensions	0,8 x 1,0 mm
Pin spacing	5.08 mm
Hole diameter	1.4 mm

Technical data

Range of articles	FKDSO 2,5/..-L
Insulating material group	I
Rated surge voltage (III/3)	4 kV
Rated surge voltage (III/2)	4 kV
Rated surge voltage (II/2)	4 kV
Rated voltage (III/3)	250 V
Rated voltage (III/2)	250 V
Rated voltage (II/2)	250 V
Connection in acc. with standard	EN-VDE
Nominal current I_N	22 A
Nominal cross section	2.5 mm ²
Maximum load current	22 A
Insulating material	PA
Inflammability class acc. to UL 94	V0
Stripping length	10 mm

Connection data

Conductor cross section solid min.	0.2 mm ²
Conductor cross section solid max.	2.5 mm ²
Conductor cross section stranded min.	0.2 mm ²
Conductor cross section stranded max.	2.5 mm ²
Conductor cross section stranded, with ferrule without plastic sleeve min.	0.25 mm ²
Conductor cross section stranded, with ferrule without plastic sleeve max.	2.5 mm ²
Conductor cross section stranded, with ferrule with plastic sleeve min.	0.25 mm ²
Conductor cross section stranded, with ferrule with plastic sleeve max.	2.5 mm ²
Conductor cross section AWG/kcmil min.	24
Conductor cross section AWG/kcmil max	14

FKDSO 2,5/ 4-L KMGY Order No.: 2200319

<http://eshop.phoenixcontact.de/phoenix/treeViewClick.do?UID=2200319>

2 conductors with same cross section, stranded, TWIN ferrules with plastic sleeve, min.	0.5 mm ²
2 conductors with same cross section, stranded, TWIN ferrules with plastic sleeve, max.	1.5 mm ²

Diagrams/Drawings

Drilling plan/solder pad geometry

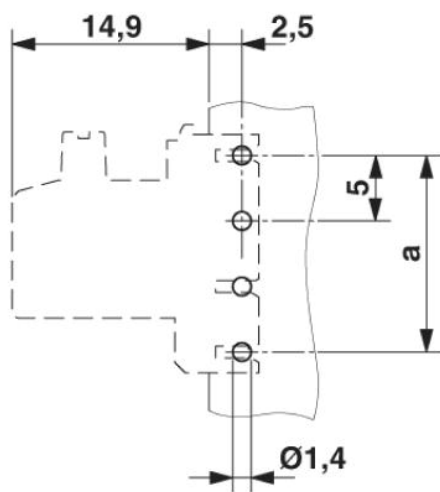

Diagram

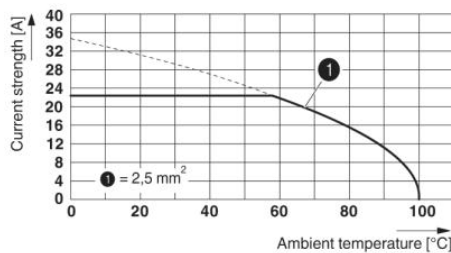

Dimensioned drawing

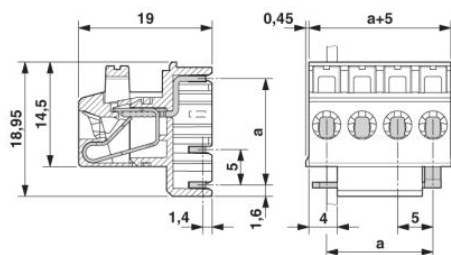

FKDSO 2,5/ 4-L KMGY Order No.: 2200319

<http://eshop.phoenixcontact.de/phoenix/treeViewClick.do?UID=2200319>

Address

PHOENIX CONTACT Inc., USA
586 Fulling Mill Road
Middletown, PA 17057, USA
Phone (800) 888-7388
Fax (717) 944-1625
<http://www.phoenixcon.com>



© 2011 Phoenix Contact
Technical modifications reserved;