

## Excellent Integrated System Limited

Stocking Distributor

Click to view price, real time Inventory, Delivery & Lifecycle Information:

[Texas Instruments](#)  
[TPA2038D1YFFR](#)

For any questions, you can email us directly:

[sales@integrated-circuit.com](mailto:sales@integrated-circuit.com)

## 3.2 W Mono Class-D Audio Power Amplifier With Selectable Gain and Auto-Recovering Short-Circuit Protection

Check for Samples: [TPA2038D1](#)

### FEATURES

- Filter-Free Mono Class-D Speaker Amp
- GAIN Pin Selects Between 6 dB and 12 dB
- 3.2 W into 4 Ω from 5 V supply at 10% THD+N
- Powerful Mono Class-D Speaker Amplifier
  - 1% at 1.4 W into 8 Ω from 5 V Supply
  - 1% at 2.5 W into 4 Ω from 5 V Supply
- Integrated Image Reject Filter for DAC Noise Reduction
- Low Output Noise of 20 μV
- Low Quiescent Current of 1.5 mA
- Auto-Recovering Short-Circuit Protection
- Thermal-Overload Protection
- 9-Ball 1,21 mm × 1,16 mm 0,4 mm Pitch WCSP

### APPLICATIONS

- Wireless or Cellular Handsets and PDAs
- Portable Navigation Devices
- General Portable Audio Devices

### DESCRIPTION

The TPA2038D1 is a 3.2 W into 4-ohm (10% THD) high efficiency filter-free class-D audio power amplifier. The GAIN pin sets gain to either 6 dB or 12 dB.

Features like 95% efficiency, 1.5 mA quiescent current, 0.5 μA shutdown current, 81 dB PSRR, 20 μV output noise, and improved RF immunity make the TPA2038D1 class-D amplifier ideal for cellular handsets. A start-up time is within 4 ms with no turn-on pop.

The TPA2038D1 is available in a 1.21 mm x 1.16 mm, 0.4 mm pitch wafer chip scale package (WCSP).

### APPLICATION CIRCUIT

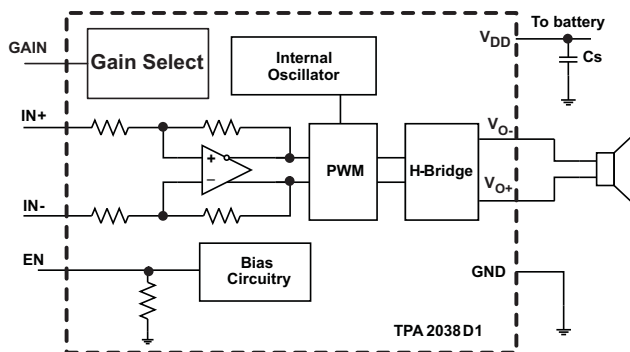

TPA2038D1  
9-BALL 0.4mm PITCH  
WAFER CHIP SCALE PACKAGE (YFF)  
(TOP VIEW OF PCB)

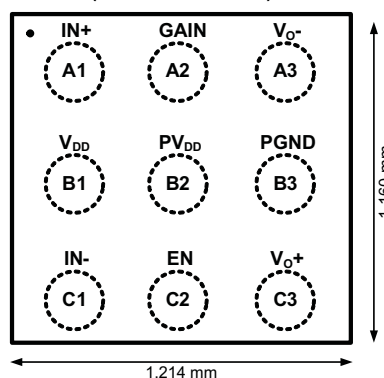

Please be aware that an important notice concerning availability, standard warranty, and use in critical applications of Texas Instruments semiconductor products and disclaimers thereto appears at the end of this data sheet.

## TPA2038D1

SLOS697A – AUGUST 2011 – REVISED OCTOBER 2012

[www.ti.com](http://www.ti.com)

These devices have limited built-in ESD protection. The leads should be shorted together or the device placed in conductive foam during storage or handling to prevent electrostatic damage to the MOS gates.

### ORDERING INFORMATION

T <sub>A</sub>	PACKAGED DEVICES <sup>(1)</sup>	PART NUMBER <sup>(2)</sup>	SYMBOL
-40°C to 85°C	9-ball WCSP	TPA2038D1YFFR	QWK
		TPA2038D1YFFT	QWK

- (1) For the most current package and ordering information, see the Package Option Addendum at the end of this document, or see the TI Web site at [www.ti.com](http://www.ti.com)
- (2) The YFF package is only available taped and reeled. The suffix "R" indicates a reel of 3000, the suffix "T" indicates a reel of 250.

### ABSOLUTE MAXIMUM RATINGS

 over operating free-air temperature range, T<sub>A</sub> = 25°C (unless otherwise noted)<sup>(1)</sup>

		VALUE	UNIT	
V <sub>DD</sub> , PV <sub>DD</sub>	Supply voltage	In active mode	-0.3 to 6.0	V
		In shutdown mode	-0.3 to 6.0	V
V <sub>I</sub>	Input voltage	EN, IN+, IN-	-0.3 to V <sub>DD</sub> + 0.3	V
R <sub>L</sub>	Minimum load resistance		3.2	Ω
	Output continuous total power dissipation	See Dissipation Rating Table		
T <sub>A</sub>	Operating free-air temperature range		-40 to 85	°C
T <sub>J</sub>	Operating junction temperature range		-40 to 150	°C
T <sub>stg</sub>	Storage temperature range		-65 to 85	°C

- (1) Stresses beyond those listed under *absolute maximum ratings* may cause permanent damage to the device. These are stress ratings only, and functional operation of the device at these or any other conditions beyond those indicated under *recommended operating conditions* is not implied. Exposure to Absolute Maximum Ratings conditions for extended periods may affect device reliability.

### DISSIPATION RATINGS

PACKAGE	DERATING FACTOR <sup>(1)</sup>	T <sub>A</sub> < 25°C	T <sub>A</sub> = 70°C	T <sub>A</sub> = 85°C
YFF (WCSP)	4.2 mW/°C	525 mW	336 mW	273 mW

- (1) Derating factor measure with high K board.

### RECOMMENDED OPERATING CONDITIONS

		MIN	MAX	UNIT
V <sub>DD</sub> , PV <sub>DD</sub>	Class-D supply voltage	2.5	5.5	V
V <sub>IH</sub>	High-level input voltage	1.3		V
V <sub>IL</sub>	Low-level input voltage		0.35	V
V <sub>IC</sub>	Common mode input voltage range	0.75	V <sub>DD</sub> -1.1	V
T <sub>A</sub>	Operating free-air temperature	-40	85	°C

### GAIN SETTING

GAIN PIN	GAIN SETTING
GND	12 dB
VDD	6 dB

**ELECTRICAL CHARACTERISTICS**

 PVDD = VDD = 3.6 V, T<sub>A</sub> = 25°C (unless otherwise noted)

PARAMETER		TEST CONDITIONS	MIN	TYP	MAX	UNIT
V <sub>OS</sub>	Output offset voltage (measured differentially)	VDD = 2.5 V to 5.5 V, GAIN = VDD		1	5	mV
I <sub>IH</sub>	High-level EN input current	VDD = 5.5 V, EN = GAIN = 5.5 V			50	μA
I <sub>IL</sub>	Low-level EN input current	VDD = 5.5 V, EN = GAIN = 0 V			1	μA
I <sub>(Q)</sub>	Quiescent current	VDD = 5.5 V, no load		1.8	2.5	mA
		VDD = 3.6 V, no load		1.5	2.3	
		VDD = 2.5 V, no load		1.3	2.1	
I <sub>(SD)</sub>	Shutdown current	EN = 0.35 V, VDD = 3.6 V		0.1	2	μA
R <sub>O, SD</sub>	Output impedance in shutdown mode	EN = 0.35 V		2		kΩ
f <sub>(SW)</sub>	Switching frequency	VDD = 2.5 V to 5.5 V	250	300	350	kHz
A <sub>V</sub>	Gain	GAIN = 0 V	11.5	12	12.5	dB
		GAIN = VDD	5.5	6	6.5	
R <sub>EN</sub>	Resistance from EN to GND			300		kΩ
R <sub>IN</sub>	Single-ended input resistance	A <sub>V</sub> = 6 dB; EN = VDD		150		kΩ
		A <sub>V</sub> = 12 dB; EN = VDD		75		
		EN = 0.35 V		75		

**OPERATING CHARACTERISTICS**

 PVDD = VDD = 3.6 V, A<sub>V</sub> = 6 dB, T<sub>A</sub> = 25°C, R<sub>L</sub> = 8 Ω (unless otherwise noted)

PARAMETER		TEST CONDITIONS	MIN	TYP	MAX	UNIT
P <sub>O</sub>	Output power	THD + N = 10%, f = 1 kHz, R <sub>L</sub> = 4 Ω	V <sub>DD</sub> = 5 V	3.24		W
			V <sub>DD</sub> = 3.6 V	1.62		
			V <sub>DD</sub> = 2.5 V	0.70		
		THD + N = 1%, f = 1 kHz, R <sub>L</sub> = 4 Ω	V <sub>DD</sub> = 5 V	2.57		W
			V <sub>DD</sub> = 3.6 V	1.32		
			V <sub>DD</sub> = 2.5 V	0.57		
		THD + N = 10%, f = 1 kHz, R <sub>L</sub> = 8 Ω	V <sub>DD</sub> = 5 V	1.80		W
			V <sub>DD</sub> = 3.6 V	0.91		
			V <sub>DD</sub> = 2.5 V	0.42		
		THD + N = 1%, f = 1 kHz, R <sub>L</sub> = 8 Ω	V <sub>DD</sub> = 5 V	1.46		W
			V <sub>DD</sub> = 3.6 V	0.74		
			V <sub>DD</sub> = 2.5 V	0.33		
E <sub>N</sub>	Output voltage noise, A <sub>V</sub> = 6 dB	V <sub>DD</sub> = 3.6 V, Inputs AC grounded with C <sub>1</sub> = 2 μF, f = 20 Hz to 20 kHz	A-weighting	20	μV <sub>RMS</sub>	
			No weighting	26		
	Output voltage noise, A <sub>V</sub> = 12 dB		A-weighting	27		
			No weighting	36		
THD+N	Total harmonic distortion plus noise	VDD = 5.0 V, P <sub>O</sub> = 1.0 W, f = 1 kHz, R <sub>L</sub> = 8 Ω		0.12%		
		VDD = 3.6 V, P <sub>O</sub> = 0.5 W, f = 1 kHz, R <sub>L</sub> = 8 Ω		0.05%		
		VDD = 2.5 V, P <sub>O</sub> = 0.2 W, f = 1 kHz, R <sub>L</sub> = 8 Ω		0.05%		
		VDD = 5.0 V, P <sub>O</sub> = 2.0 W, f = 1 kHz, R <sub>L</sub> = 4 Ω		0.32%		
		VDD = 3.6 V, P <sub>O</sub> = 1.0 W, f = 1 kHz, R <sub>L</sub> = 4 Ω		0.11%		
		VDD = 2.5 V, P <sub>O</sub> = 0.4 W, f = 1 kHz, R <sub>L</sub> = 4 Ω		0.12%		
PSRR	AC power supply rejection ratio	A <sub>V</sub> = 6 dB, Inputs AC grounded with C <sub>1</sub> = 2 μF, 200 mV <sub>pp</sub> ripple, f = 217 Hz		81	dB	
		A <sub>V</sub> = 12 dB, Inputs AC grounded with C <sub>1</sub> = 2 μF, 200 mV <sub>pp</sub> ripple, f = 217 Hz		82		

## TPA2038D1

SLOS697A – AUGUST 2011 – REVISED OCTOBER 2012

www.ti.com

### OPERATING CHARACTERISTICS (continued)

PVDD = VDD = 3.6 V,  $A_V = 6$  dB,  $T_A = 25^\circ\text{C}$ ,  $R_L = 8 \Omega$  (unless otherwise noted)

PARAMETER	TEST CONDITIONS	MIN	TYP	MAX	UNIT
CMRR Common mode rejection ratio	$A_V = 6$ dB, $V_{IC} = 200$ mV <sub>PP</sub> , $f = 217$ Hz		79		dB
	$A_V = 12$ dB, $V_{IC} = 200$ mV <sub>PP</sub> , $f = 217$ Hz		77		
T <sub>SU</sub> Startup time from shutdown			4		ms
I <sub>SC</sub> Short circuit protection threshold	V <sub>O+</sub> shorted to VDD		2		A
	V <sub>O-</sub> shorted to VDD				
	V <sub>O+</sub> shorted to GND				
	V <sub>O-</sub> shorted to GND				
	V <sub>O+</sub> shorted to V <sub>O-</sub>				
T <sub>AR</sub> Overcurrent recovery time	VDD = 2.5 V to 5.5 V		100		ms

### Terminal Functions

TERMINAL		I/O	DESCRIPTION
NAME	WCSP BALL		
IN+	A1	I	Positive audio input.
GAIN	A2	I	Gain select. Set to GND for 12 dB; set to VDD for 6 dB.
V <sub>O-</sub>	A3	O	Negative audio output.
VDD	B1	I	Power supply terminal. Connect to PVDD using a direct connection.
PVDD	B2	I	Class-D output power supply. Connect to VDD using a direct connection.
GND	B3	I	Ground.
IN-	C1	I	Negative audio input.
EN	C2	I	Enable. Set to logic high to enable device.
V <sub>O+</sub>	C3	O	Positive audio output.

### FUNCTIONAL BLOCK DIAGRAM

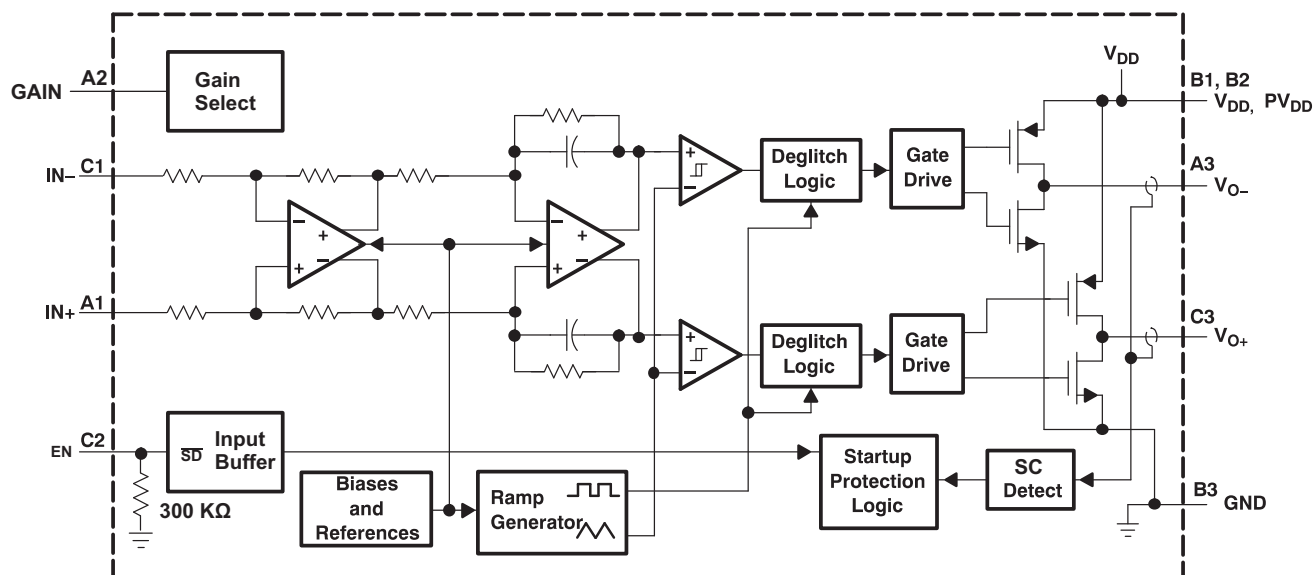

**TEST SETUP FOR GRAPHS**

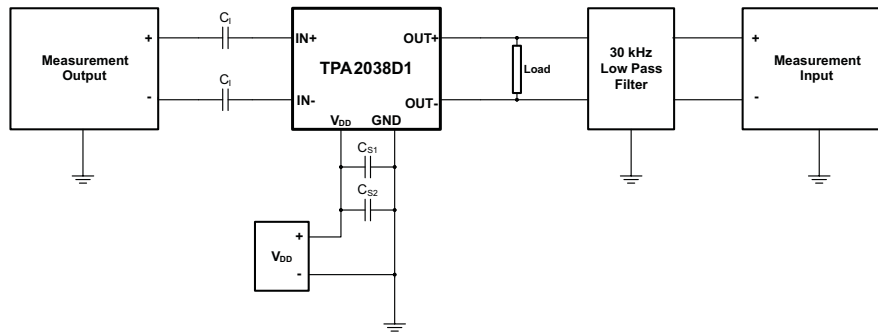

1.  $C_1$  was shorted for any common-mode input voltage measurement. All other measurements were taken with  $C_1 = 0.1 \mu\text{F}$  (unless otherwise noted).
2.  $C_{S1} = 0.1 \mu\text{F}$  is placed very close to the device. The optional  $C_{S2} = 10 \mu\text{F}$  is used for datasheet graphs.
3. The 30 kHz low-pass filter is required even if the analyzer has an internal low-pass filter. An RC low-pass filter (1 k $\Omega$ , 4700 pF) is used on each output for the data sheet graphs.

**TPA2038D1**

SLOS697A – AUGUST 2011 – REVISED OCTOBER 2012

www.ti.com

**TYPICAL CHARACTERISTICS**

PVDD = VDD = 3.6 V, C<sub>I</sub> = 0.1 μF, C<sub>S1</sub> = 0.1 μF, C<sub>S2</sub> = 10 μF, T<sub>A</sub> = 25°C, R<sub>L</sub> = 8 Ω (unless otherwise noted)

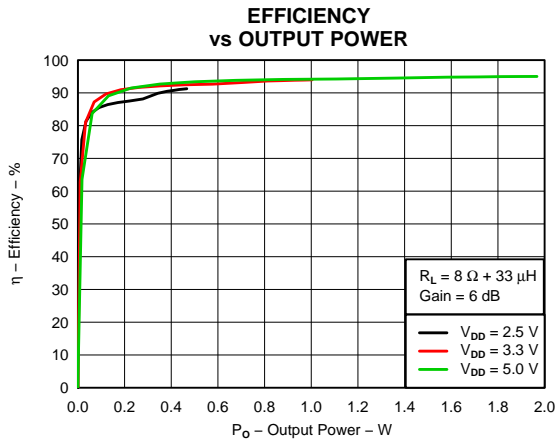

Figure 1.

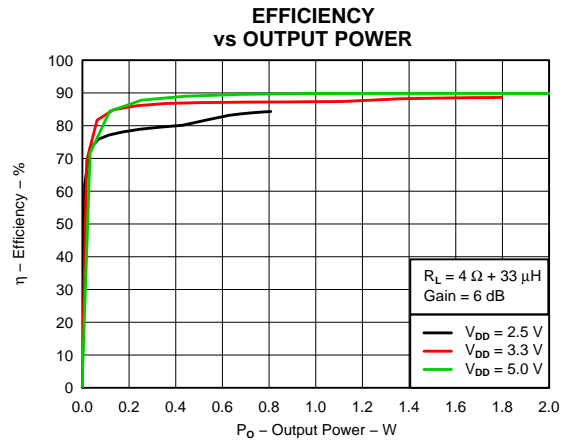

Figure 2.

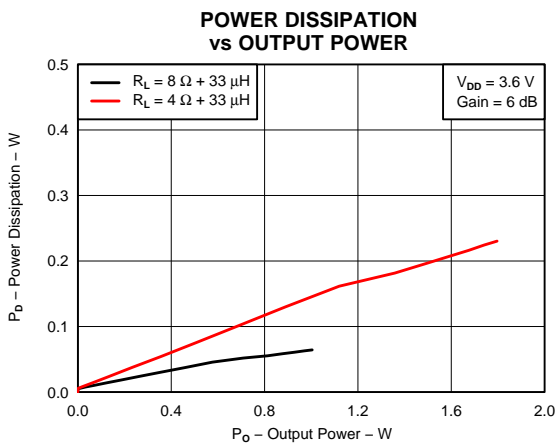

Figure 3.

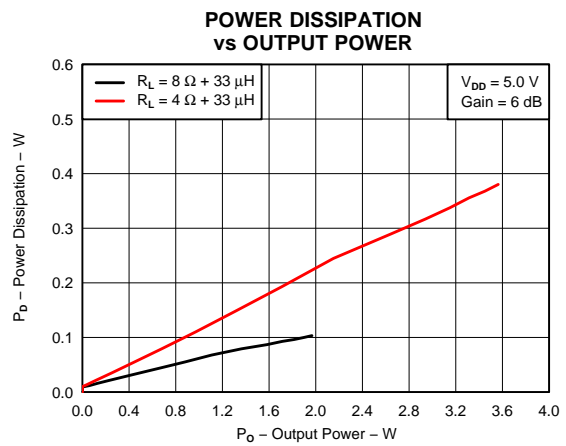

Figure 4.

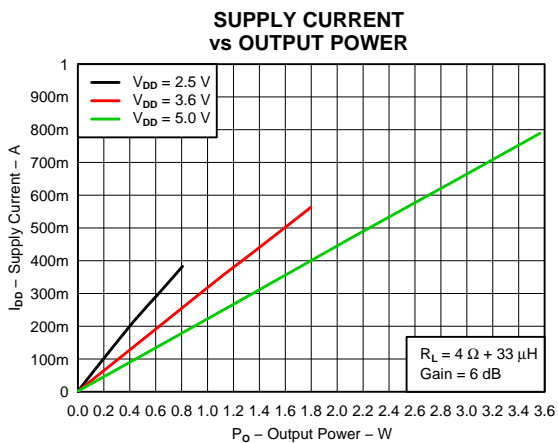

Figure 5.

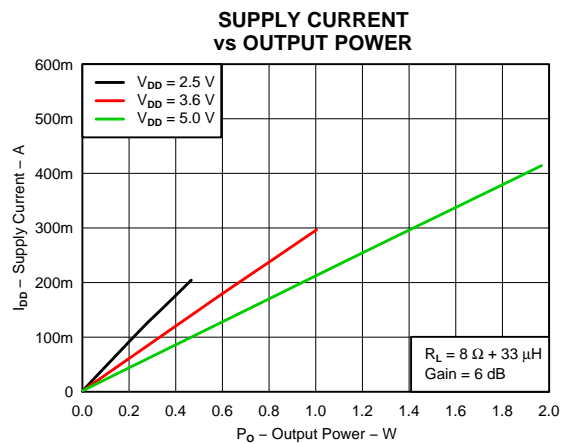
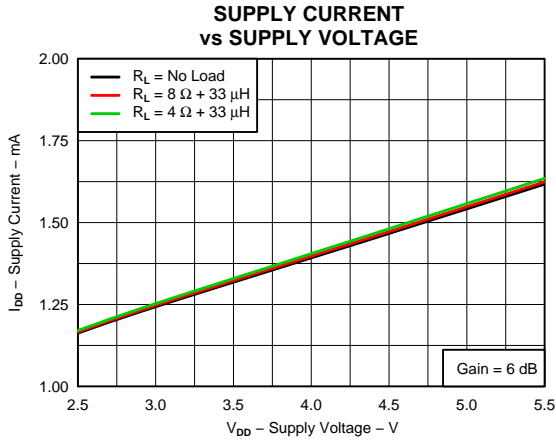

Figure 6.

**TYPICAL CHARACTERISTICS (continued)**

PVDD = VDD = 3.6 V, C<sub>1</sub> = 0.1 μF, C<sub>S1</sub> = 0.1 μF, C<sub>S2</sub> = 10 μF, T<sub>A</sub> = 25°C, R<sub>L</sub> = 8 Ω (unless otherwise noted)



**Figure 7.**

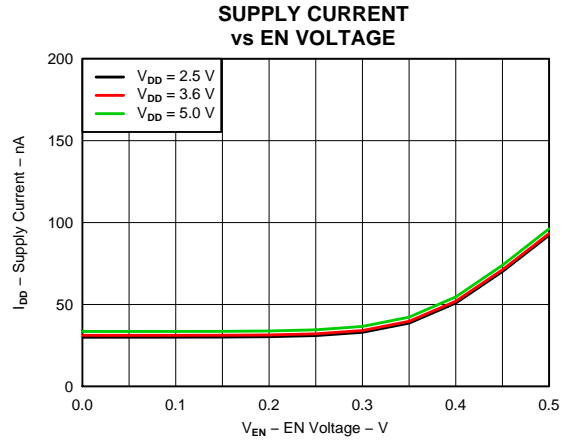

**Figure 8.**

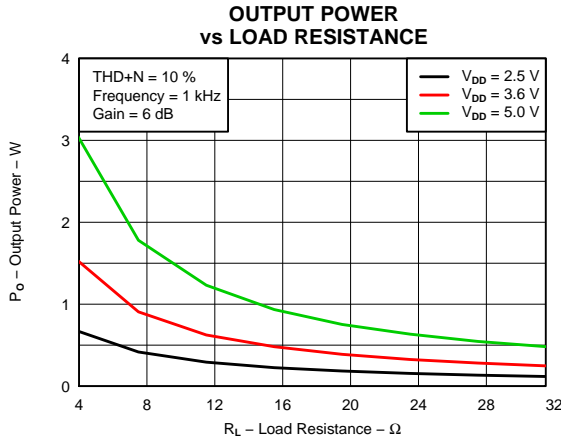

**Figure 9.**

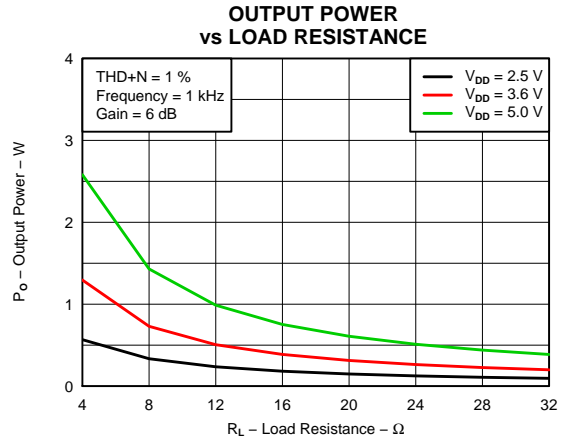

**Figure 10.**

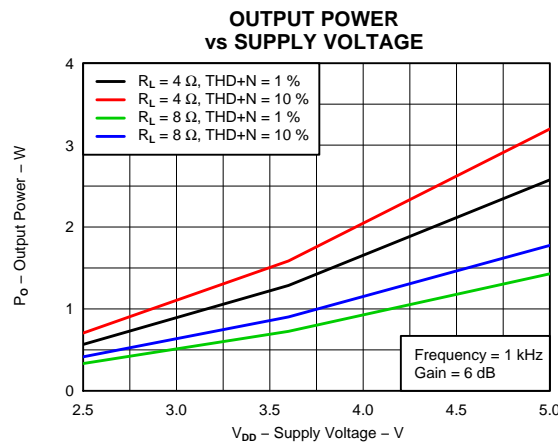

**Figure 11.**



**TPA2038D1**

SLOS697A – AUGUST 2011 – REVISED OCTOBER 2012

www.ti.com

**TYPICAL CHARACTERISTICS (continued)**

PVDD = VDD = 3.6 V, C<sub>1</sub> = 0.1 μF, C<sub>S1</sub> = 0.1 μF, C<sub>S2</sub> = 10 μF, T<sub>A</sub> = 25°C, R<sub>L</sub> = 8 Ω (unless otherwise noted)

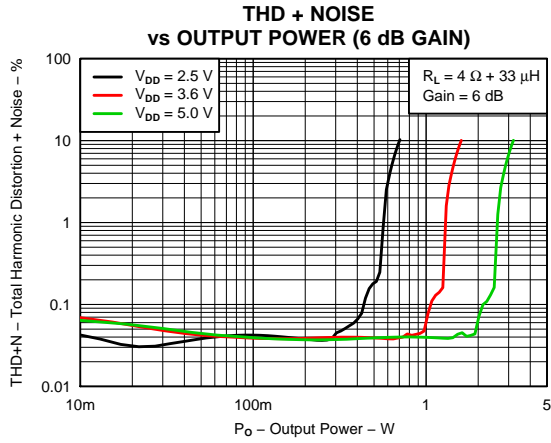

Figure 12.

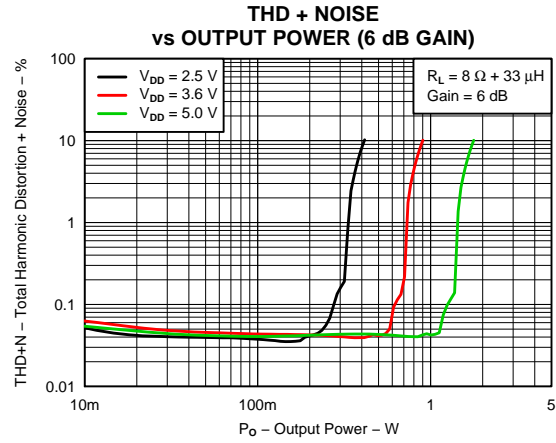

Figure 13.

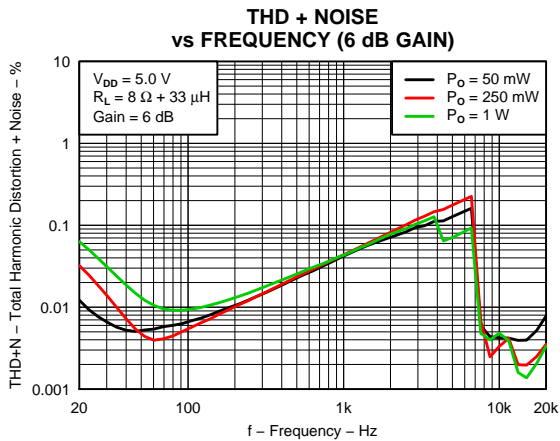

Figure 14.

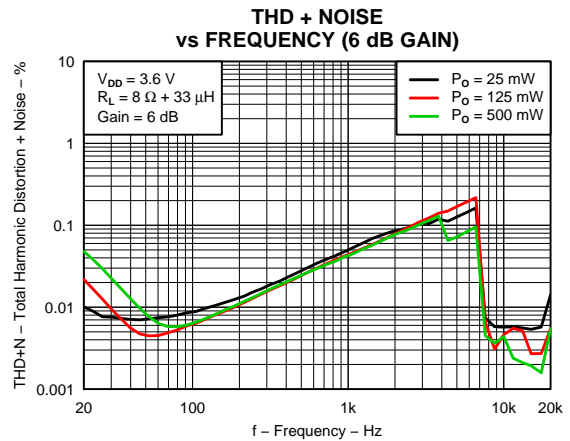

Figure 15.

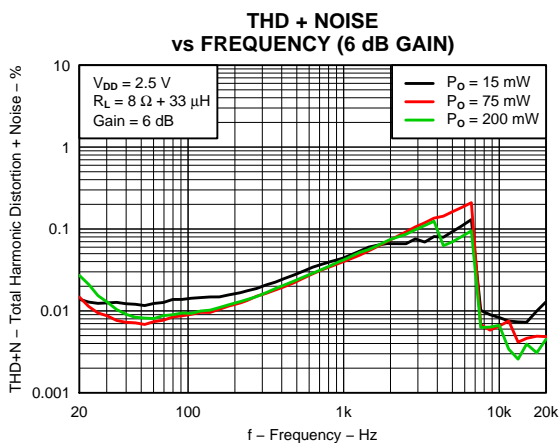

Figure 16.

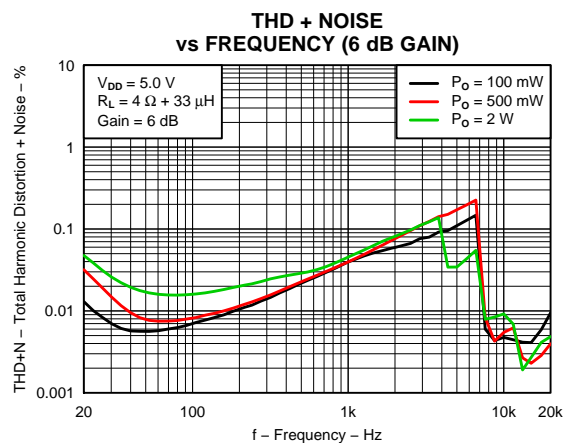

Figure 17.

**TYPICAL CHARACTERISTICS (continued)**

PVDD = VDD = 3.6 V, C<sub>I</sub> = 0.1 μF, C<sub>S1</sub> = 0.1 μF, C<sub>S2</sub> = 10 μF, T<sub>A</sub> = 25°C, R<sub>L</sub> = 8 Ω (unless otherwise noted)

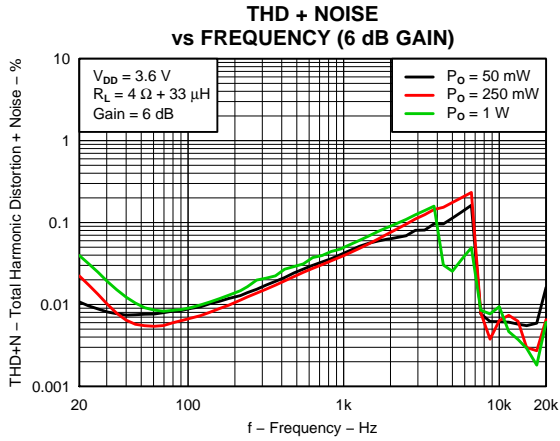

Figure 18.

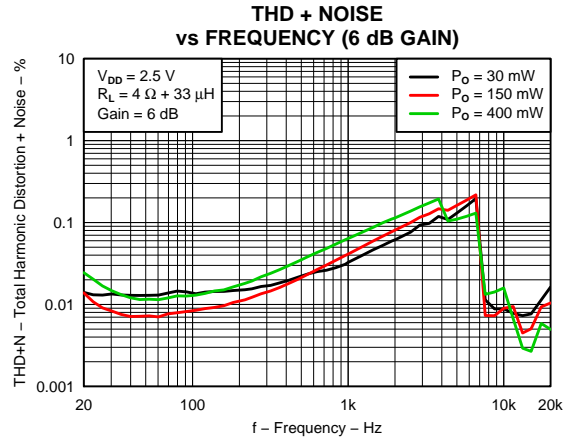

Figure 19.

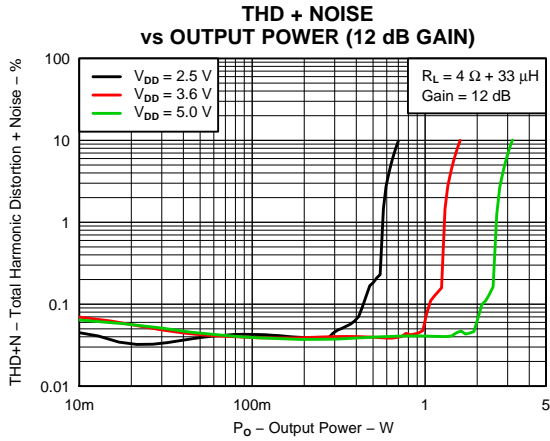

Figure 20.

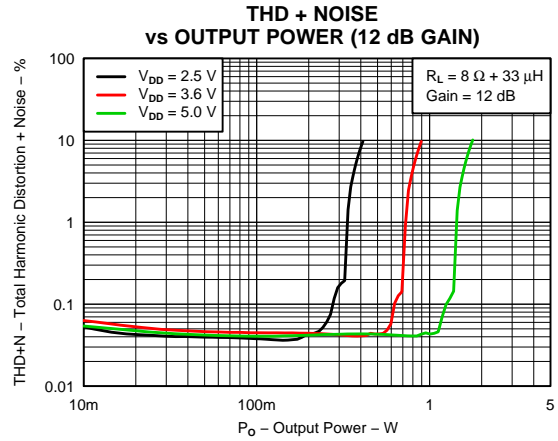

Figure 21.

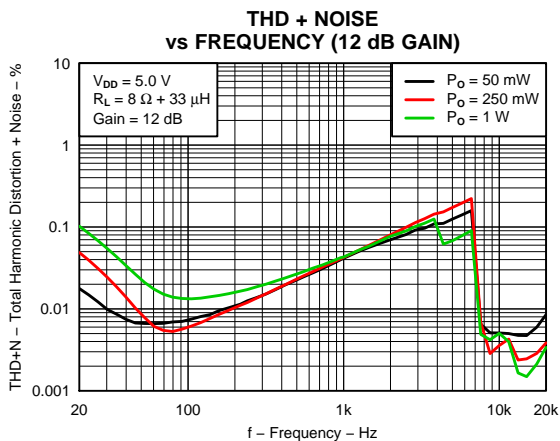

Figure 22.

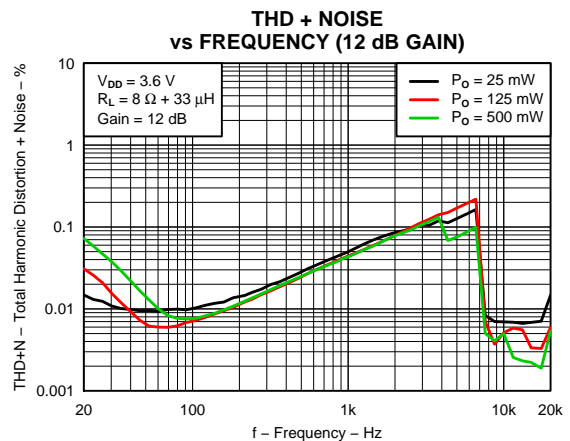

Figure 23.

**TPA2038D1**

SLOS697A – AUGUST 2011 – REVISED OCTOBER 2012

www.ti.com

**TYPICAL CHARACTERISTICS (continued)**

PVDD = VDD = 3.6 V, C<sub>i</sub> = 0.1 μF, C<sub>S1</sub> = 0.1 μF, C<sub>S2</sub> = 10 μF, T<sub>A</sub> = 25°C, R<sub>L</sub> = 8 Ω (unless otherwise noted)

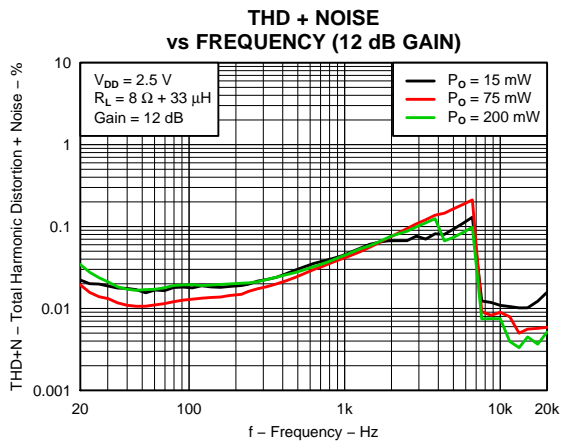

Figure 24.

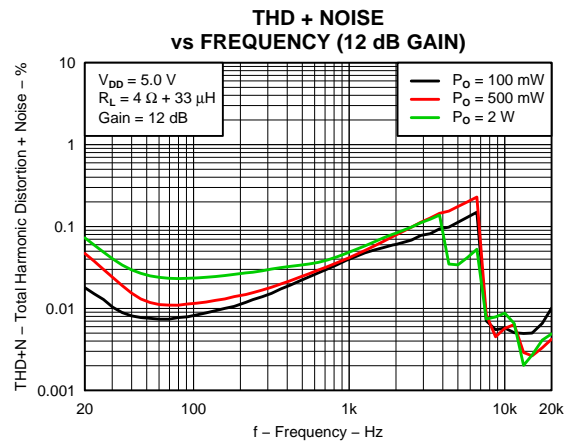

Figure 25.

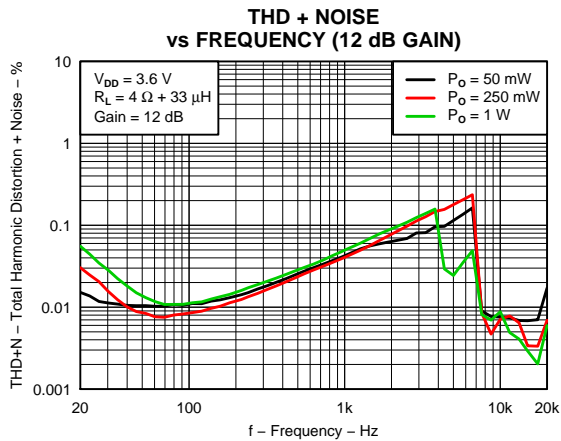

Figure 26.

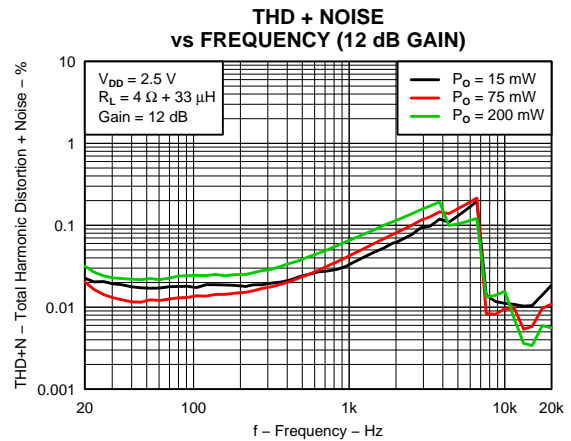

Figure 27.

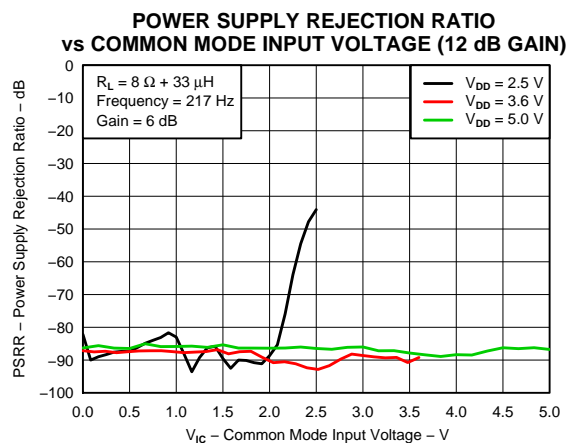

Figure 28.

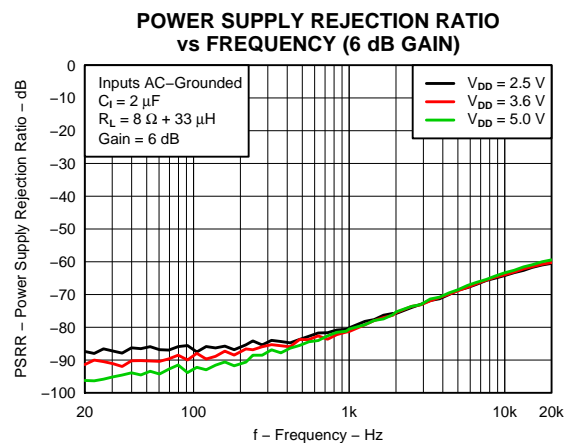

Figure 29.

**TYPICAL CHARACTERISTICS (continued)**

PVDD = VDD = 3.6 V, C<sub>I</sub> = 0.1 μF, C<sub>S1</sub> = 0.1 μF, C<sub>S2</sub> = 10 μF, T<sub>A</sub> = 25°C, R<sub>L</sub> = 8 Ω (unless otherwise noted)

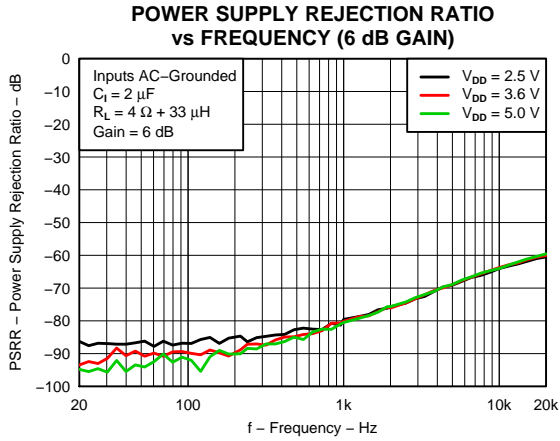

Figure 30.

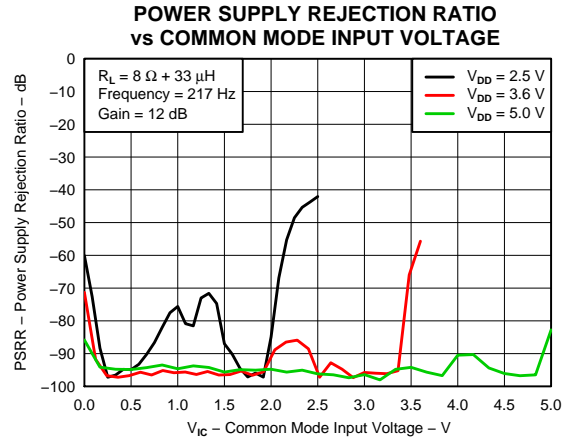

Figure 31.

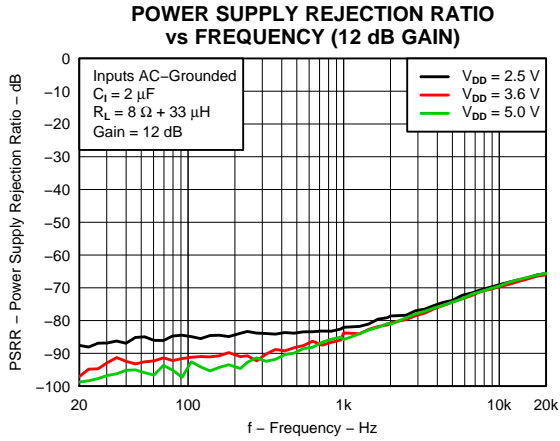

Figure 32.

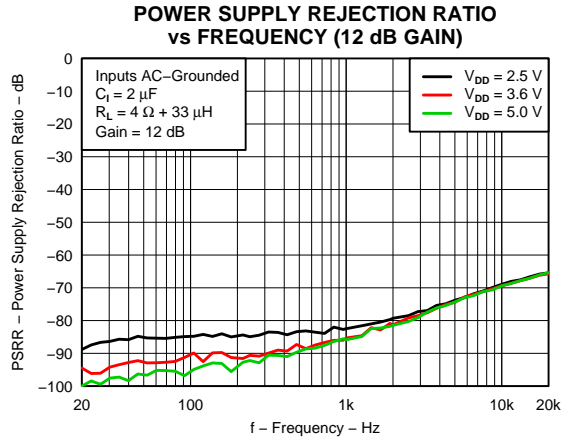

Figure 33.

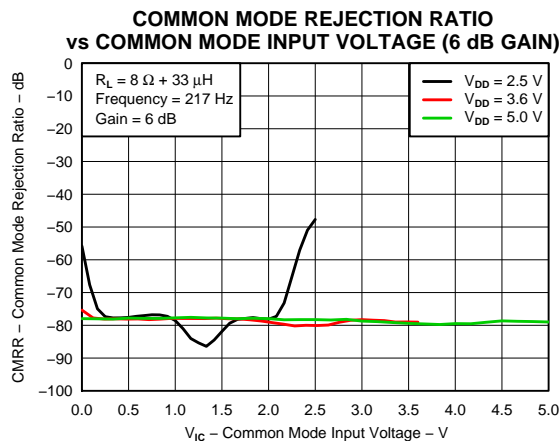

Figure 34.

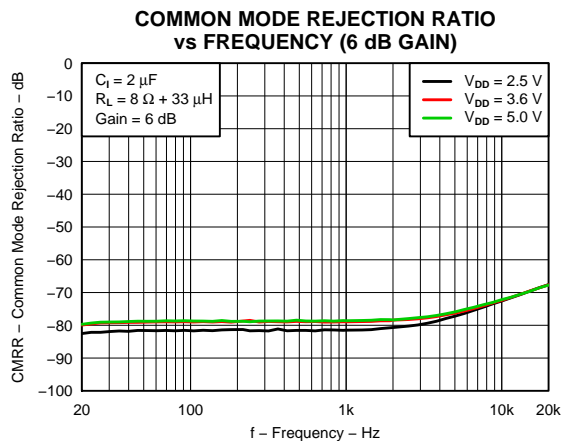

Figure 35.

**TPA2038D1**

SLOS697A – AUGUST 2011 – REVISED OCTOBER 2012

www.ti.com

**TYPICAL CHARACTERISTICS (continued)**

PVDD = VDD = 3.6 V, C<sub>1</sub> = 0.1 μF, C<sub>S1</sub> = 0.1 μF, C<sub>S2</sub> = 10 μF, T<sub>A</sub> = 25°C, R<sub>L</sub> = 8 Ω (unless otherwise noted)

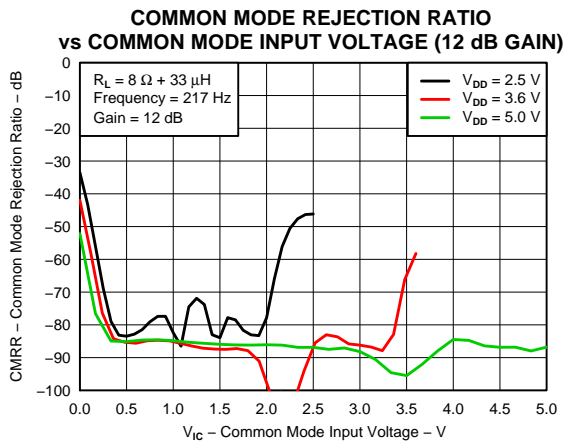

Figure 36.

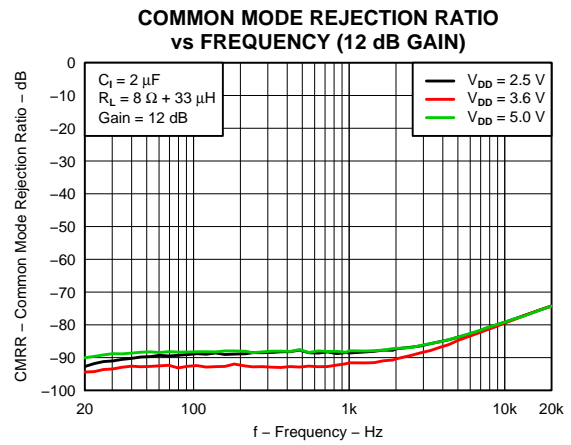

Figure 37.

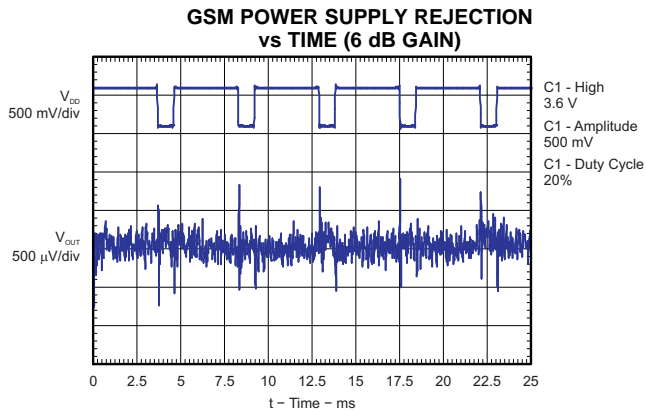

Figure 38.

G026

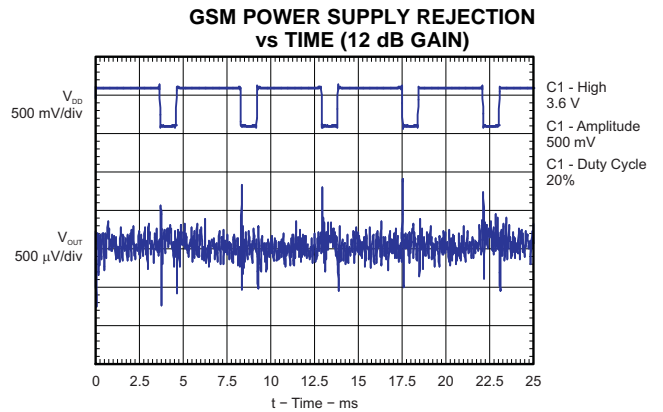

Figure 39.

G026

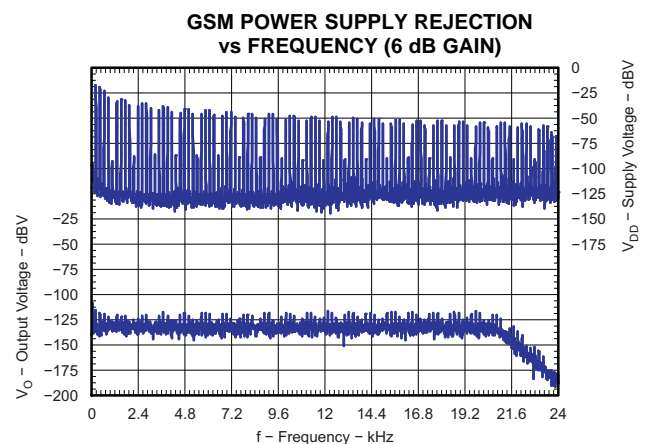

Figure 40.

G027

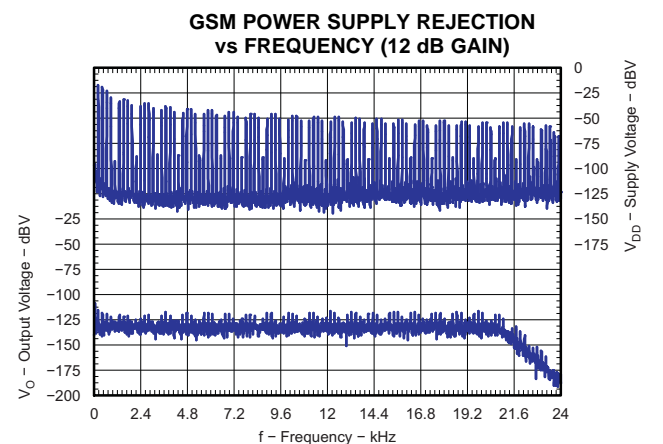

Figure 41.

G027

## APPLICATION INFORMATION

### SHORT CIRCUIT AUTO-RECOVERY

When a short-circuit event occurs, the TPA2038D1 goes to shutdown mode and activates the integrated auto-recovery process whose aim is to return the device to normal operation once the short-circuit is removed. This process repeatedly examines (once every 100 ms) whether the short-circuit condition persists, and returns the device to normal operation immediately after the short-circuit condition is removed. This feature helps protect the device from large currents and maintain a good long-term reliability.

### INTEGRATED IMAGE REJECT FILTER FOR DAC NOISE REJECTION

In applications which use a DAC to drive Class-D amplifiers, out-of-band noise energy present at the DAC's image frequencies fold back into the audio-band at the output of the Class-D amplifier. An external low-pass filter is often placed between the DAC and the Class-D amplifier in order to attenuate this noise.

The TPA2038D1 has an integrated Image Reject Filter with a low-pass cutoff frequency of 130 kHz, which significantly attenuates this noise. Depending on the system noise specification, the integrated Image Reject Filter may help eliminate external filtering, thereby saving board space and component cost.

### COMPONENT SELECTION

Figure 42 shows the TPA2038D1 typical schematic with differential inputs, while Figure 43 shows the TPA2038D1 with differential inputs and input capacitors. Figure 44 shows the TPA2038D1 with a single-ended input.

#### Decoupling Capacitors ( $C_{S1}$ , $C_{S2}$ )

The TPA2038D1 is a high-performance class-D audio amplifier that requires adequate power supply decoupling to ensure the efficiency is high and total harmonic distortion (THD) is low. For higher frequency transients, spikes, or digital hash on the line, a good low equivalent-series-resistance (ESR) ceramic capacitor  $C_{S1} = 0.1 \mu\text{F}$ , placed as close as possible to the device  $V_{DD}$  lead works best. Placing  $C_{S1}$  close to the TPA2038D1 is important for the efficiency of the class-D amplifier, because any resistance or inductance in the trace between the device and the capacitor can cause a loss in efficiency. For filtering lower-frequency noise signals, a  $10 \mu\text{F}$  or greater capacitor ( $C_{S2}$ ) placed near the audio power amplifier would also help, but it is not required in most applications because of the high PSRR of this device. Typically, the smaller the capacitor's case size, the lower the inductance and the closer it can be placed to the TPA2038D1. X5R and X7R dielectric capacitors are recommended for both  $C_{S1}$  and  $C_{S2}$ .

#### Input Capacitors ( $C_I$ )

The TPA2038D1 does not require input coupling capacitors if the design uses a differential source that is biased within the common-mode input voltage range. That voltage range is listed in the Recommended Operating Conditions table. If the input signal is not biased within the recommended common-mode input range, such as in needing to use the input as a high pass filter, shown in Figure 43, or if using a single-ended source, shown in Figure 44, input coupling capacitors are required. The same value capacitors should be used on both IN+ and IN– for best pop performance. The 3 dB high-pass cutoff frequency  $f_C$  of the filter formed by the input coupling capacitor  $C_I$  and the input resistance  $R_I$  (typically 150 k $\Omega$ ) of the TPA2038D1 is given by Equation 1:

$$f_C = \frac{1}{(2\pi R_I C_I)} \quad (1)$$

The value of the input capacitor is important to consider as it directly affects the bass (low frequency) performance of the circuit. Speaker response may also be taken into consideration when setting the corner frequency using input capacitors. Solving for the input coupling capacitance, we get:

$$C_I = \frac{1}{(2\pi R_I f_C)} \quad (2)$$

If the corner frequency is within the audio band, the capacitors should have a tolerance of  $\pm 10\%$  or better, because any mismatch in capacitance causes an impedance mismatch at the corner frequency and below.

**TPA2038D1**

SLOS697A –AUGUST 2011–REVISED OCTOBER 2012

www.ti.com

For a flat low-frequency response, use large input coupling capacitors (0.1  $\mu$ F or larger). X5R and X7R dielectric capacitors are recommended.

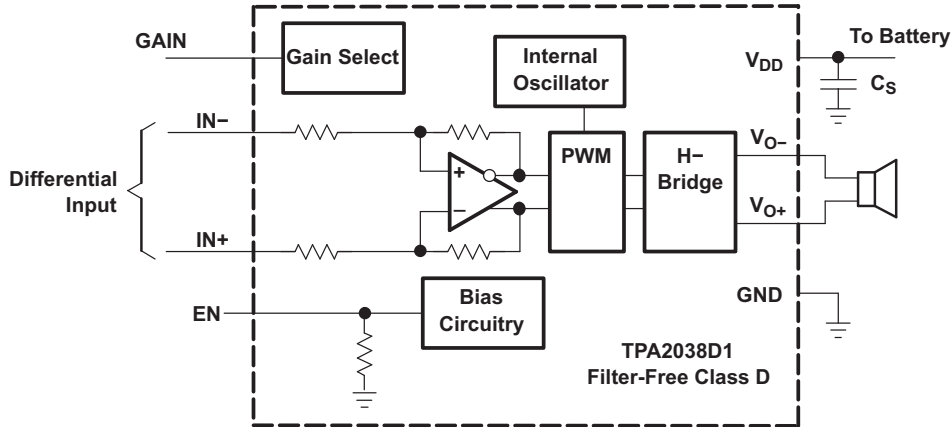

Figure 42. Typical TPA2038D1 Application Schematic With DC-coupled Differential Input

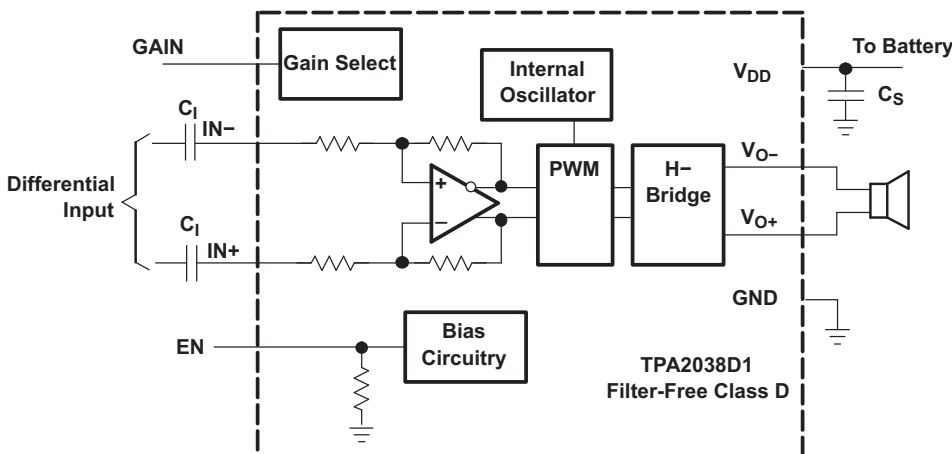

Figure 43. TPA2038D1 Application Schematic With Differential Input and Input Capacitors

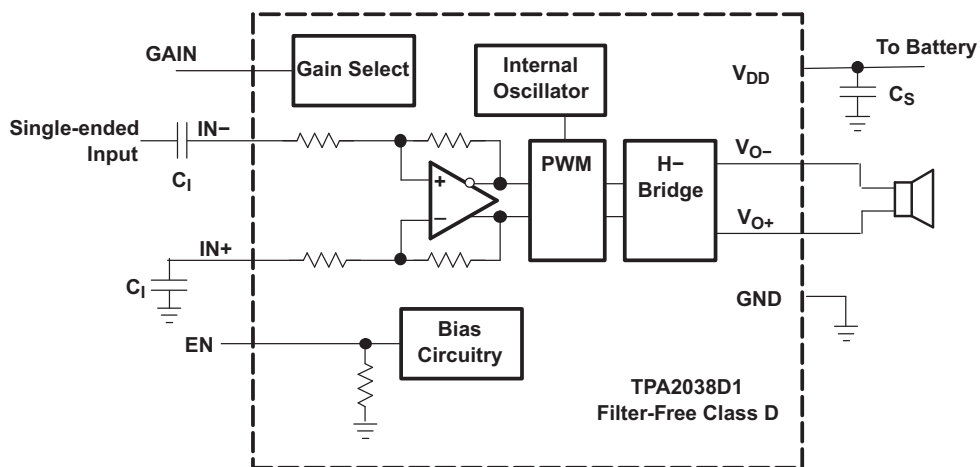

Figure 44. TPA2038D1 Application Schematic With Single-Ended Input

## EFFICIENCY AND THERMAL INFORMATION

The maximum ambient operating temperature of the TPA2038D1 depends on the load resistance, power supply voltage and heat-sinking ability of the PCB system. The derating factor for the YFF package is shown in the dissipation rating table. Converting this to  $\theta_{JA}$ :

$$\theta_{JA} = \frac{1}{\text{Derating Factor}} \quad (3)$$

Given  $\theta_{JA}$  (from the Package Dissipation ratings table), the maximum allowable junction temperature (from the Absolute Maximum ratings table), and the maximum internal dissipation (from Power Dissipation vs Output Power figures) the maximum ambient temperature can be calculated with the following equation. Note that the units on these figures are Watts RMS. Because audio contains crest factors (ratio of peak power to RMS power) from 9–15 dB, thermal limitations are not usually encountered.

$$T_{A\text{Max}} = T_{J\text{Max}} - \theta_{JA} P_{D\text{max}} \quad (4)$$

The TPA2038D1 is designed with thermal protection that turns the device off when the junction temperature surpasses 150°C to prevent damage to the IC. Note that the use of speakers less resistive than 4  $\Omega$  (typ) is not advisable. Below 4  $\Omega$  (typ) the thermal performance of the device dramatically reduces because of increased output current and reduced amplifier efficiency. The Absolute Maximum rating of 3.2  $\Omega$  covers the manufacturing tolerance of a 4  $\Omega$  speaker and speaker impedance decrease due to frequency.  $\theta_{JA}$  is a gross approximation of the complex thermal transfer mechanisms between the device and its ambient environment. If the  $\theta_{JA}$  calculation reveals a potential problem, a more accurate estimate should be made.

## WHEN TO USE AN OUTPUT FILTER

Design the TPA2038D1 without an Inductor / Capacitor (LC) output filter if the traces from the amplifier to the speaker are short. Wireless handsets and PDAs are great applications for this class-D amplifier to be used without an output filter.

The TPA2038D1 does not require an LC output filter for short speaker connections (approximately 100 mm long or less). A ferrite bead can often be used in the design if failing radiated emissions testing without an LC filter; and, the frequency-sensitive circuit is greater than 1 MHz. If choosing a ferrite bead, choose one with high impedance at high frequencies, but very low impedance at low frequencies. The selection must also take into account the currents flowing through the ferrite bead. Ferrites can begin to lose effectiveness at much lower than rated current values. See the EVM User's Guide (SLOU298) for components used successfully by TI.

Figure 45 shows a typical ferrite-bead output filter.

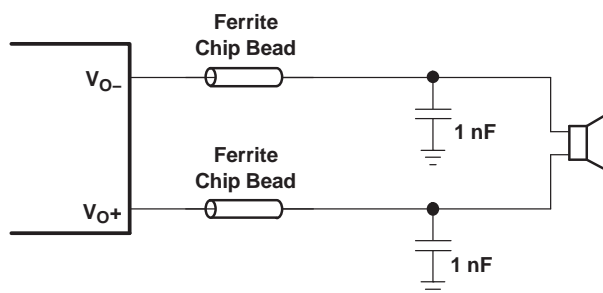

**Figure 45. Typical Ferrite Chip Bead Filter**



**TPA2038D1**

SLOS697A –AUGUST 2011–REVISED OCTOBER 2012

www.ti.com

**PRINTED CIRCUIT BOARD LAYOUT**

In making the pad size for the WCSP balls, it is recommended that the layout use non-solder-mask-defined (NSMD) land. With this method, the solder mask opening is made larger than the desired land area, and the opening size is defined by the copper pad width. Figure 46 shows the appropriate diameters for a WCSP layout.

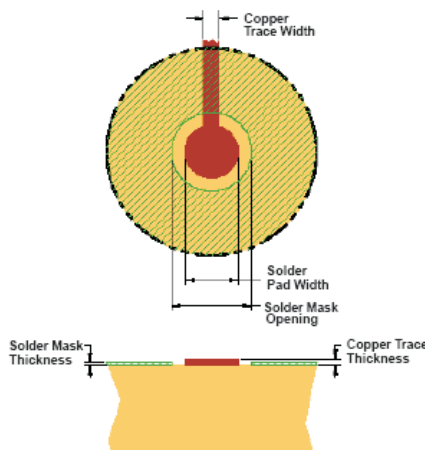

**Figure 46. Land Pattern Image and Dimensions**

SOLDER PAD DEFINITIONS	COPPER PAD	SOLDER MASK OPENING <sup>(5)</sup>	COPPER THICKNESS	STENCIL OPENING <sup>(6)(7)</sup>	STENCIL THICKNESS
Non-solder-mask-defined (NSMD)	0.23 mm	0.310 mm	1 oz max (0.032 mm)	0.275 mm x 0.275 mm Sq. (rounded corners)	0.1 mm thick

1. Circuit traces from NSMD defined PWB lands should be 75 µm to 100 µm wide in the exposed area inside the solder mask opening. Wider trace widths reduce device stand off and impact reliability.
2. Best reliability results are achieved when the PWB laminate glass transition temperature is above the operating the range of the intended application.
3. Recommend solder paste is Type 3 or Type 4.
4. For a PWB using a Ni/Au surface finish, the gold thickness should be less 0.5 µm to avoid a reduction in thermal fatigue performance.
5. Solder mask thickness should be less than 20 µm on top of the copper circuit pattern
6. Best solder stencil performance is achieved using laser cut stencils with electro polishing. Use of chemically etched stencils give inferior solder paste volume control.
7. Trace routing away from WCSP device should be balanced in X and Y directions to avoid unintentional component movement due to solder wetting forces.

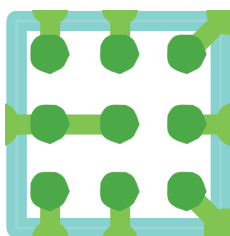

**Figure 47. Layout Snapshot**

An on-pad via is not required to route the middle ball B2 (PV<sub>DD</sub>) of the TPA2038D1. Short ball B2 (PV<sub>DD</sub>) to ball B1 (V<sub>DD</sub>) and connect both to the supply trace as shown in Figure 47. This simplifies board routing and saves manufacturing cost.

**PACKAGE DIMENSIONS**

<b>D</b>	<b>E</b>
Max = 1190µm	Max = 1244µm
Min = 1130µm	Min = 1184µm

## TPA2038D1

SLOS697A – AUGUST 2011 – REVISED OCTOBER 2012

[www.ti.com](http://www.ti.com)

### REVISION HISTORY

Changes from Original (August 2011) to Revision A	Page
• Changed in first sentence of Description, 8-ohm to 4-ohm .....	1
• Changed D and E dimensions in the Package Dimensions table. ....	17



PACKAGING INFORMATION

Orderable Device	Status (1)	Package Type	Package Drawing	Pins	Package Qty	Eco Plan (2)	Lead/Ball Finish	MSL Peak Temp (3)	Op Temp (°C)	Top-Side Markings (4)	Samples
TPA2038D1YFFR	ACTIVE	DSBGA	YFF	9	3000	Green (RoHS & no Sb/Br)	SNAGCU	Level-1-260C-UNLIM	-40 to 85	QWK	
TPA2038D1YFFT	ACTIVE	DSBGA	YFF	9	250	Green (RoHS & no Sb/Br)	SNAGCU	Level-1-260C-UNLIM	-40 to 85	QWK	

(1) The marketing status values are defined as follows:

**ACTIVE:** Product device recommended for new designs.

**LIFEBUY:** TI has announced that the device will be discontinued, and a lifetime-buy period is in effect.

**NRND:** Not recommended for new designs. Device is in production to support existing customers, but TI does not recommend using this part in a new design.

**PREVIEW:** Device has been announced but is not in production. Samples may or may not be available.

**OBSELETE:** TI has discontinued the production of the device.

(2) Eco Plan - The planned eco-friendly classification: Pb-Free (RoHS), Pb-Free (RoHS Exempt), or Green (RoHS & no Sb/Br) - please check <http://www.ti.com/productcontent> for the latest availability information and additional product content details.

**TBD:** The Pb-Free/Green conversion plan has not been defined.

**Pb-Free (RoHS):** TI's terms "Lead-Free" or "Pb-Free" mean semiconductor products that are compatible with the current RoHS requirements for all 6 substances, including the requirement that lead not exceed 0.1% by weight in homogeneous materials. Where designed to be soldered at high temperatures, TI Pb-Free products are suitable for use in specified lead-free processes.

**Pb-Free (RoHS Exempt):** This component has a RoHS exemption for either 1) lead-based flip-chip solder bumps used between the die and package, or 2) lead-based die adhesive used between the die and leadframe. The component is otherwise considered Pb-Free (RoHS compatible) as defined above.

**Green (RoHS & no Sb/Br):** TI defines "Green" to mean Pb-Free (RoHS compatible), and free of Bromine (Br) and Antimony (Sb) based flame retardants (Br or Sb do not exceed 0.1% by weight in homogeneous material)

(3) MSL, Peak Temp. -- The Moisture Sensitivity Level rating according to the JEDEC industry standard classifications, and peak solder temperature.

(4) Multiple Top-Side Markings will be inside parentheses. Only one Top-Side Marking contained in parentheses and separated by a "-" will appear on a device. If a line is indented then it is a continuation of the previous line and the two combined represent the entire Top-Side Marking for that device.

**Important Information and Disclaimer:** The information provided on this page represents TI's knowledge and belief as of the date that it is provided. TI bases its knowledge and belief on information provided by third parties, and makes no representation or warranty as to the accuracy of such information. Efforts are underway to better integrate information from third parties. TI has taken and continues to take reasonable steps to provide representative and accurate information but may not have conducted destructive testing or chemical analysis on incoming materials and chemicals. TI and TI suppliers consider certain information to be proprietary, and thus CAS numbers and other limited information may not be available for release.

In no event shall TI's liability arising out of such information exceed the total purchase price of the TI part(s) at issue in this document sold by TI to Customer on an annual basis.

**TAPE AND REEL INFORMATION**

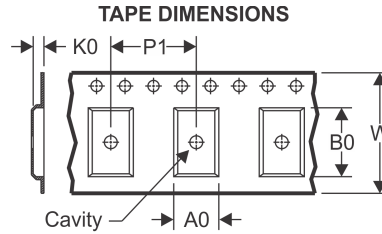
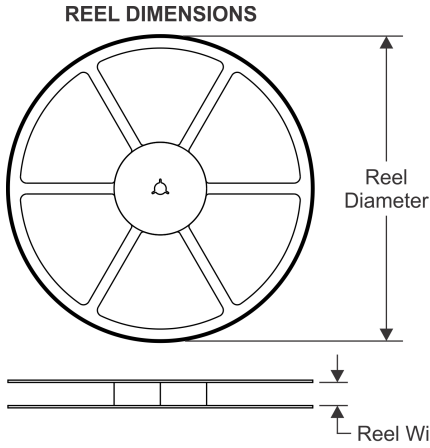

A0	Dimension designed to accommodate the component width
B0	Dimension designed to accommodate the component length
K0	Dimension designed to accommodate the component thickness
W	Overall width of the carrier tape
P1	Pitch between successive cavity centers

**QUADRANT ASSIGNMENTS FOR PIN 1 ORIENTATION IN TAPE**

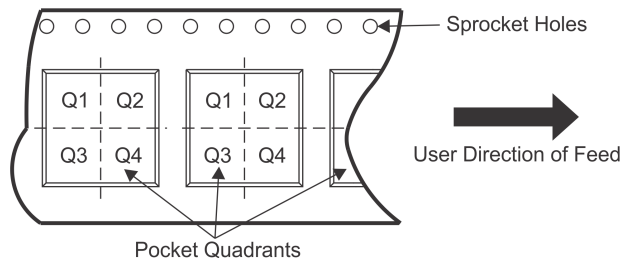

\*All dimensions are nominal

Device	Package Type	Package Drawing	Pins	SPQ	Reel Diameter (mm)	Reel Width W1 (mm)	A0 (mm)	B0 (mm)	K0 (mm)	P1 (mm)	W (mm)	Pin1 Quadrant
TPA2038D1YFFR	DSBGA	YFF	9	3000	180.0	8.4	1.34	1.34	0.81	4.0	8.0	Q1
TPA2038D1YFFT	DSBGA	YFF	9	250	180.0	8.4	1.34	1.34	0.81	4.0	8.0	Q1

**TAPE AND REEL BOX DIMENSIONS**

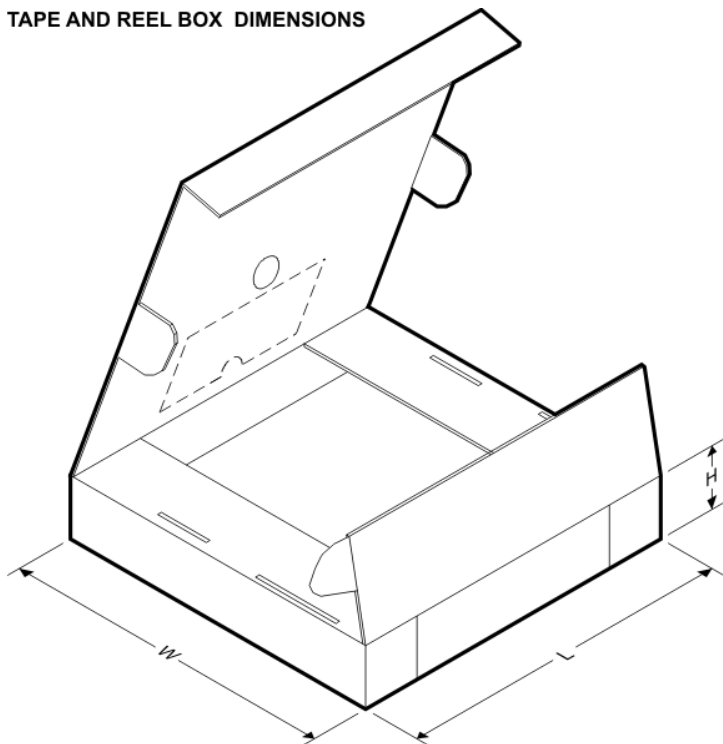

\*All dimensions are nominal

Device	Package Type	Package Drawing	Pins	SPQ	Length (mm)	Width (mm)	Height (mm)
TPA2038D1YFFR	DSBGA	YFF	9	3000	182.0	182.0	20.0
TPA2038D1YFFT	DSBGA	YFF	9	250	182.0	182.0	20.0

## IMPORTANT NOTICE

Texas Instruments Incorporated and its subsidiaries (TI) reserve the right to make corrections, enhancements, improvements and other changes to its semiconductor products and services per JESD46, latest issue, and to discontinue any product or service per JESD48, latest issue. Buyers should obtain the latest relevant information before placing orders and should verify that such information is current and complete. All semiconductor products (also referred to herein as “components”) are sold subject to TI’s terms and conditions of sale supplied at the time of order acknowledgment.

TI warrants performance of its components to the specifications applicable at the time of sale, in accordance with the warranty in TI’s terms and conditions of sale of semiconductor products. Testing and other quality control techniques are used to the extent TI deems necessary to support this warranty. Except where mandated by applicable law, testing of all parameters of each component is not necessarily performed.

TI assumes no liability for applications assistance or the design of Buyers’ products. Buyers are responsible for their products and applications using TI components. To minimize the risks associated with Buyers’ products and applications, Buyers should provide adequate design and operating safeguards.

TI does not warrant or represent that any license, either express or implied, is granted under any patent right, copyright, mask work right, or other intellectual property right relating to any combination, machine, or process in which TI components or services are used. Information published by TI regarding third-party products or services does not constitute a license to use such products or services or a warranty or endorsement thereof. Use of such information may require a license from a third party under the patents or other intellectual property of the third party, or a license from TI under the patents or other intellectual property of TI.

Reproduction of significant portions of TI information in TI data books or data sheets is permissible only if reproduction is without alteration and is accompanied by all associated warranties, conditions, limitations, and notices. TI is not responsible or liable for such altered documentation. Information of third parties may be subject to additional restrictions.

Resale of TI components or services with statements different from or beyond the parameters stated by TI for that component or service voids all express and any implied warranties for the associated TI component or service and is an unfair and deceptive business practice. TI is not responsible or liable for any such statements.

Buyer acknowledges and agrees that it is solely responsible for compliance with all legal, regulatory and safety-related requirements concerning its products, and any use of TI components in its applications, notwithstanding any applications-related information or support that may be provided by TI. Buyer represents and agrees that it has all the necessary expertise to create and implement safeguards which anticipate dangerous consequences of failures, monitor failures and their consequences, lessen the likelihood of failures that might cause harm and take appropriate remedial actions. Buyer will fully indemnify TI and its representatives against any damages arising out of the use of any TI components in safety-critical applications.

In some cases, TI components may be promoted specifically to facilitate safety-related applications. With such components, TI’s goal is to help enable customers to design and create their own end-product solutions that meet applicable functional safety standards and requirements. Nonetheless, such components are subject to these terms.

No TI components are authorized for use in FDA Class III (or similar life-critical medical equipment) unless authorized officers of the parties have executed a special agreement specifically governing such use.

Only those TI components which TI has specifically designated as military grade or “enhanced plastic” are designed and intended for use in military/aerospace applications or environments. Buyer acknowledges and agrees that any military or aerospace use of TI components which have **not** been so designated is solely at the Buyer’s risk, and that Buyer is solely responsible for compliance with all legal and regulatory requirements in connection with such use.

TI has specifically designated certain components as meeting ISO/TS16949 requirements, mainly for automotive use. In any case of use of non-designated products, TI will not be responsible for any failure to meet ISO/TS16949.

### Products

Audio	<a href="http://www.ti.com/audio">www.ti.com/audio</a>
Amplifiers	<a href="http://amplifier.ti.com">amplifier.ti.com</a>
Data Converters	<a href="http://dataconverter.ti.com">dataconverter.ti.com</a>
DLP® Products	<a href="http://www.dlp.com">www.dlp.com</a>
DSP	<a href="http://dsp.ti.com">dsp.ti.com</a>
Clocks and Timers	<a href="http://www.ti.com/clocks">www.ti.com/clocks</a>
Interface	<a href="http://interface.ti.com">interface.ti.com</a>
Logic	<a href="http://logic.ti.com">logic.ti.com</a>
Power Mgmt	<a href="http://power.ti.com">power.ti.com</a>
Microcontrollers	<a href="http://microcontroller.ti.com">microcontroller.ti.com</a>
RFID	<a href="http://www.ti-rfid.com">www.ti-rfid.com</a>
OMAP Applications Processors	<a href="http://www.ti.com/omap">www.ti.com/omap</a>
Wireless Connectivity	<a href="http://www.ti.com/wirelessconnectivity">www.ti.com/wirelessconnectivity</a>

### Applications

Automotive and Transportation	<a href="http://www.ti.com/automotive">www.ti.com/automotive</a>
Communications and Telecom	<a href="http://www.ti.com/communications">www.ti.com/communications</a>
Computers and Peripherals	<a href="http://www.ti.com/computers">www.ti.com/computers</a>
Consumer Electronics	<a href="http://www.ti.com/consumer-apps">www.ti.com/consumer-apps</a>
Energy and Lighting	<a href="http://www.ti.com/energy">www.ti.com/energy</a>
Industrial	<a href="http://www.ti.com/industrial">www.ti.com/industrial</a>
Medical	<a href="http://www.ti.com/medical">www.ti.com/medical</a>
Security	<a href="http://www.ti.com/security">www.ti.com/security</a>
Space, Avionics and Defense	<a href="http://www.ti.com/space-avionics-defense">www.ti.com/space-avionics-defense</a>
Video and Imaging	<a href="http://www.ti.com/video">www.ti.com/video</a>

### TI E2E Community

[e2e.ti.com](http://e2e.ti.com)