

## Excellent Integrated System Limited

Stocking Distributor

Click to view price, real time Inventory, Delivery & Lifecycle Information:

[Molex Connector Corporation](#)  
[0758272234](#)

For any questions, you can email us directly:  
[sales@integrated-circuit.com](mailto:sales@integrated-circuit.com)

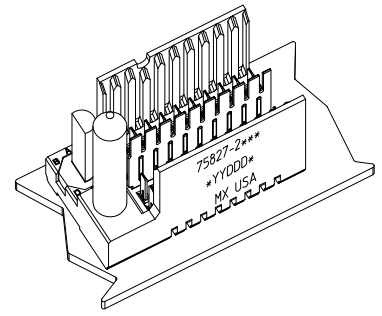
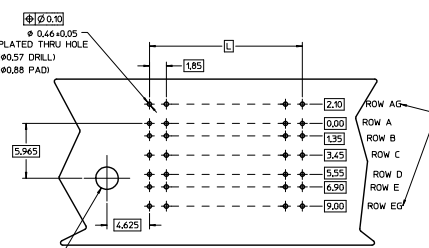
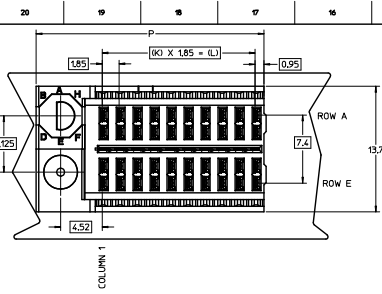

THE PRIMARY CARTON WITH A LABEL STATING "ELV AND RoHS COMPLIANT" IS LEAD FREE. CARTONS WITHOUT THIS LABEL MAY CONTAIN LEAD.

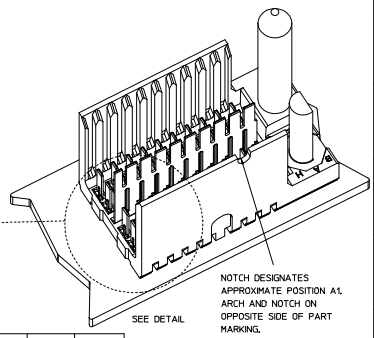
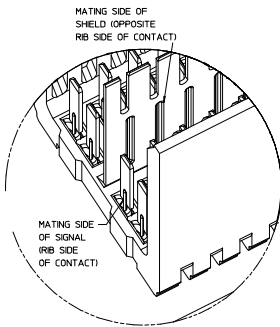
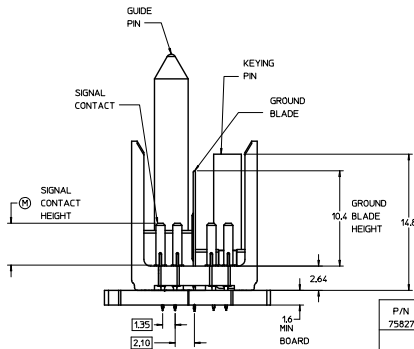
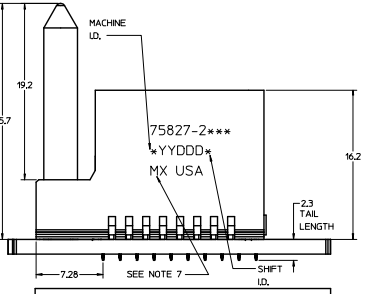

PART NUMBER TABLE				
ASSY PART NO.	K	L	P	TOTAL NO. OF DIFFERENTIAL PAIRS
75827-21**	9	16.65	24.78	20
75827-22**	24	44.40	52.53	50

- NOTES:
- MATERIAL: HOUSING - LIQUID CRYSTAL POLYMER (LCP) GLASS-FILLED, UL 94V-0. COLOR - GRAY. SIGNAL CONTACT AND GROUND BLADE - HIGH PERFORMANCE COPPER ALLOY.
  - FINISHES: SELECTIVE GOLD (Au) ON CONTACT AREA, SELECTIVE MATTE TIN (Sn) ON PCB TAILS, NICKEL (Ni) OVERALL.
  - THIS PART CONFORMS TO MOLEX PRODUCT SPECIFICATION PS-75221-999.
  - FOR MIXED CONTACT MATING LENGTHS CONSULT MOLEX FOR AVAILABILITY. CONTACT PAIRS MUST BE THE SAME LENGTH.
  - FOR SPECIFIC PART NUMBER AND MATING INFORMATION PLEASE REFER TO CHART.
  - PACKAGE PER PK-70873-5058.
  - EITHER MARK PART NUMBER AND DATE CODE APPROXIMATELY WHERE SHOWN OR PLACE A LABEL ON THE TUBE.
  - OPTIONAL HOLE LOCATION FOR GROUNDED GUIDE PIN OR ADDITIONAL GUIDE PIN SUPPORT. FOR GROUNDED GUIDE, HOLE TO BE PLATED, DRILL SIZE #2.58 PAD SIZE #3.50
  - THESE PARTS CONFORM TO MOLEX COSMETIC SPECIFICATION PS-45499-002 CLASS B.
  - HAPS (MOLEX ADVANCED PLATING SYSTEM).

MODULE ORIENTATION LEFT = 2

KEYING ORIENTATION COLUMN \* \* \* \* \*  
 0 - NONE 1-10 COL.  
 1 - A 2-25 COL.  
 ETC...

PN LENGTH DM "H"	GOLD (Au) THICKNESS micrometers
0-3.55 mm	0.25 (MAPS)
1-4.55 mm	
2-5.55 mm	0.76
3-5.55 mm	
4-4.55 mm	
5-5.55 mm	
7-3.55 mm	1.27
8-3.55 mm	
9-5.55 mm	

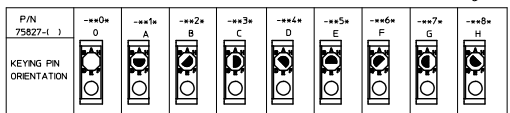

LEAD-FREE PLATING

REV TO LEAD-FREE EC NO. UFP2013-0090 DOWNGRADES 2017/09/05 CHROMIUM-PLATE 2017/09/05 APPROVALS 2017/09/05 REV	QUALITY SYMBOLS	GENERAL TOLERANCES (UNLESS SPECIFIED)	DIMENSION STYLE	SCALE	DESIGN UNITS	THIRD ANGLE PROJECTION	
	∇=0 ∇=0 ∇=0	4 PLACES ±--- ±--- 3 PLACES ±--- ±--- 2 PLACES ±0.25 ±--- 1 PLACE ±0.38 ±--- 0 PLACE ± ±	MM ONLY	5:1	METRIC	DRAWN BY: MARTIN CHECKED BY: JMYCZEK APPROVED BY: SREED DATE: 2005/07/01 DATE: 2005/07/01 DATE: 2005/07/01	TITLE: GBX 2-PAIR, LF LEFT END BACKPLANE SALES ASSEMBLY MATERIAL NO. SD-75827-210 DOCUMENT NO. SD-75827-210 SHEET NO. 1 OF 1
	ANGULAR ±1/2° DRAFT WHERE APPLICABLE MUST REMAIN WITHIN DIMENSIONS	SEE TABLE					
		THIS DRAWING CONTAINS INFORMATION THAT IS PROPRIETARY TO MOLEX INCORPORATED AND SHOULD NOT BE USED WITHOUT WRITTEN PERMISSION					