

Excellent Integrated System Limited

Stocking Distributor

Click to view price, real time Inventory, Delivery & Lifecycle Information:

[Molex Connector Corporation](#)
[0760555106](#)

For any questions, you can email us directly:

sales@integrated-circuit.com

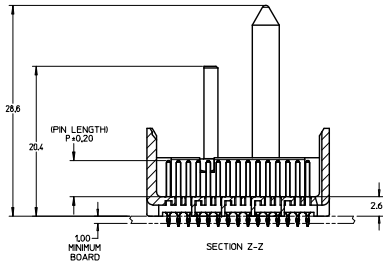
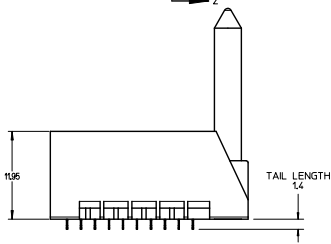
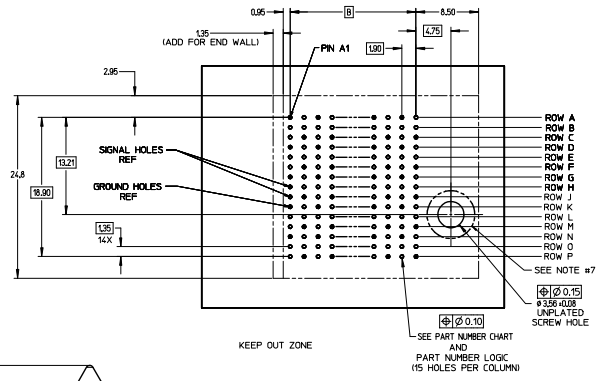
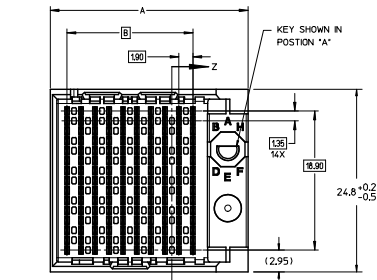

RIGHT GUIDED
BACKPLANE HOLE PATTERN
(CONNECTOR SIDE)
SEE NOTE 12

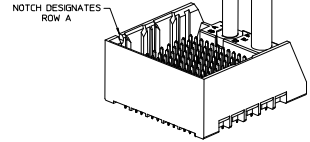

NOTES:

1. MATERIALS: HOUSING - LIQUID CRYSTAL POLYMER (LCP)
GLASS-FILLED, UL94V-0
TERMINALS - HIGH PERFORMANCE COPPER ALLOY
2. FINISH: 30μ MIN GOLD IN CONTACT AREA,
SELECTIVE TIN ON PCB TAILS,
NICKEL OVERALL.
3. REFER TO MOLEX PRODUCT SPECIFICATION PS-76060-999
FOR PERFORMANCE SPECIFICATIONS AND ADDITIONAL PCB INFORMATION.
4. THIS PART CONFORMS TO CLASS B REQUIREMENTS OF
MOLEX COSMETIC SPEC PS-45499-002.
5. PACKAGE PER: PK-70873-759.
6. SEE SHEETS 2 & 3 FOR PART NUMBERS AND BOARD RELATIONSHIPS.
7. FOR GROUNDED GUIDE PINS USE DIA. 3.56 +/-0.08 (PTH)
DIA. 3.66 (DRILL) AND DIA. 6.5 (PAD).
8. MATES WITH IMPACT DC SERIES NO. 76060.
9. KEEP OUT ZONE FOR BP HOUSING LENGTH INCLUDES AN ADDITIONAL 10MM
TO ACCOMMODATE FOR SPACE REQUIRED BY DC FRONT HOUSING.
10. REFER TO MOLEX PCB ROUTING GUIDE AS-76060-990 FOR ANTI PAD AND ROUTING RECOMMENDATIONS.
11. CONNECTORS SUPPLIED WITH A 2-56 UNC-2A SCREW.
12. *THESE DIMENSIONS REPRESENT THE AREA NEEDED TO ACCOMMODATE CONNECTOR INSERTION AND REPAIR
ON THE PC BOARD. THIS IS REFERRED TO AS THE "CONNECTOR KEEP OUT ZONE" AND DOES NOT
REPRESENT THE ACTUAL PERIMETER OF THE CONNECTOR. WHEN LAYING OUT A PC BOARD FOR CONNECTORS
STACKED TOGETHER, USE A 19mm PROGRESSION.*

CONVERT TO LEAD-FREE EC NO. UEP2003-2008 DRAWN BY: BARBA 2010/11/26 CHECKED BY: NINGMA 2010/12/18 APPR/SIT/EL: 2010/12/18 REV:	QUALITY SYMBOLS	GENERAL TOLERANCES (UNLESS SPECIFIED)	DIMENSION STYLE MM ONLY	SCALE 4:1	DESIGN UNITS METRIC	THIRD ANGLE PROJECTION	
	$\nabla=0$ $\nabla=0$ $\nabla=0$	4 PLACES ±--- 3 PLACES ±--- 2 PLACES ±0.13 1 PLACE ±0.25 0 PLACE ±	mm INCH ±--- ±--- ±--- ±--- ±--- ±--- ±--- ±---	DRAWN BY: MSANDBERG CHECKED BY: JLAURX APPROVED BY: JLAURX DATE: 05/24/2007 DATE: 05/24/2007 DATE: 2010/10/15			
		ANGULAR ±1/2°					
		DRAFT WHERE APPLICABLE MUST REMAIN WITHIN DIMENSIONS	SEE TABLE				
			MATERIAL NO. SD-76055-003 DOCUMENT NO. SD-76055-003 SHEET NO. 1 OF 3		TITLE: IMPACT 5 PAIR HEADER RIGHT GUIDED ASSEMBLY SALES DRAWING molex		

PART NUMBER LOGIC

76055-****

MODULE TYPE
 5 = GUIDE RIGHT, TIN
 9 = GUIDE RIGHT END WALL, TIN

PIN LENGTH (P)
 3 = 4.50 (SHORT COMPLIANT, 0.46±0.05 PTH)
 4 = 4.90 (SHORT COMPLIANT, 0.46±0.05 PTH)
 5 = 5.50 (SHORT COMPLIANT, 0.46±0.05 PTH)
 6 = 4.50 (MICRO COMPLIANT, 0.39±0.05 PTH)
 7 = 4.90 (MICRO COMPLIANT, 0.39±0.05 PTH)
 8 = 5.50 (MICRO COMPLIANT, 0.39±0.05 PTH)

KEY ORIENTATION
 0 = NO KEY
 1 = A
 2 = B
 3 = C
 4 = D
 5 = E
 6 = F
 7 = G
 8 = H

OF COLUMNS
 1 = 10 COL
 2 = 12 COL
 6 = 16 COL
 7 = 14 COL

PART NUMBER TABLE

MATERIAL NUMBER	# OF COLUMNS	# OF DIFF PAIR	DIM "A"	DIM "B"	GUIDE RIGHT END WALL OPTION
76055-1**	10	50	26.9	17.10	
76055-2**	12	60	30.7	20.90	
76055-7**	14	70	34.5	24.70	
76055-6**	16	80	38.3	28.50	

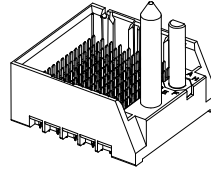

GUIDE RIGHT
END WALL
OPTION

MATERIAL NUMBER	# OF COLUMNS	# OF DIFF PAIR	DIM "A"	DIM "B"	GUIDE RIGHT OPEN WALL OPTION
76055-1**	10	50	25.5	17.10	
76055-2**	12	60	29.3	20.90	
76055-7**	14	70	33.1	24.70	
76055-6**	16	80	36.9	28.50	

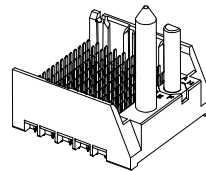

GUIDE RIGHT
OPEN WALL
OPTION

SEE SHEET 1 EC NO: UCP2015-2078 DRAWN BY: IBARRA CHKD BY: INGHAM APPR: MILLER DATE: 2012/11/28 DATE: 2012/12/18 DATE: 2012/12/31	QUALITY SYMBOLS ∇=0 ∇=0 ∇=0	GENERAL TOLERANCES (UNLESS SPECIFIED)		DIMENSION STYLE MM ONLY		SCALE 2:1	DESIGN UNITS METRIC	THIRD ANGLE PROJECTION	
		4 PLACES ± --- ± ---	mm	INCH	DRAWN BY	DATE	TITLE IMPACT 5 PAIR HEADER RIGHT GUIDED ASSEMBLY SALES DRAWING molex MATERIAL NO. SD-76055-003 DOCUMENT NO. SHEET NO. 2 OF 3		
		3 PLACES ± --- ± ---	MSANDBERG	05/24/2007					
		2 PLACES ± 0.13 ± ---	CHECKED BY	DATE					
1 PLACE ± 0.25 ± ---	JLAURX	05/24/2007							
0 PLACE ± ±	APPROVED BY	DATE	ANGULAR ± 1/2° DRAFT WHERE APPLICABLE MUST REMAIN WITHIN DIMENSIONS		SEE TABLE SIZE C		THIS DRAWING CONTAINS INFORMATION THAT IS PROPRIETARY TO MOLEX INCORPORATED AND SHOULD NOT BE USED WITHOUT WRITTEN PERMISSION		

IMPACT 5 PAIR
BOARD RELATIONSHIPS

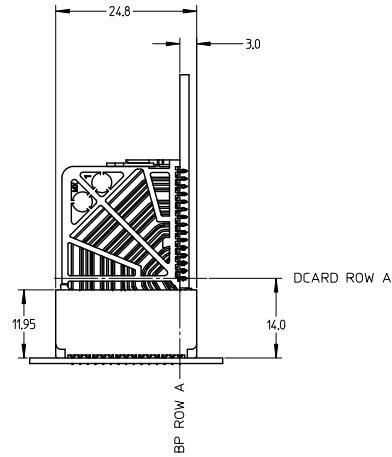
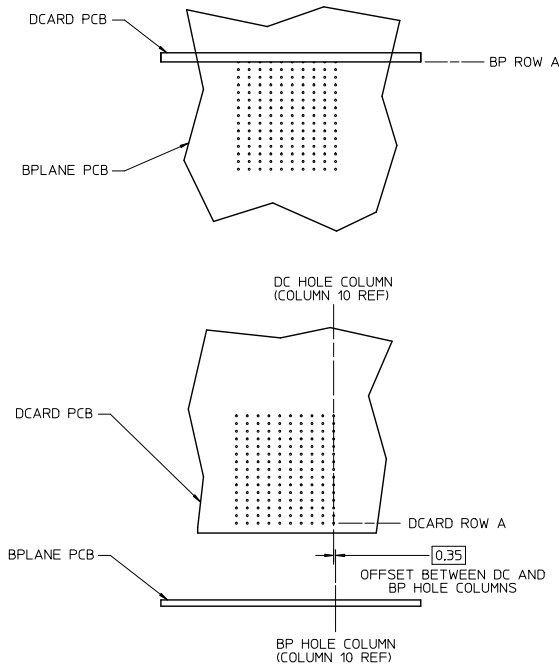

SEE SHEET 1 EC NO: UCF2013-2078 DRAWN BY: BARRA 2012/11/28 CHECKED BY: INGHAM 2012/12/18 APPROVED BY: MILLER 2012/12/31	QUALITY SYMBOLS ∇=0 ∇=0 ∇=0	GENERAL TOLERANCES (UNLESS SPECIFIED)		DIMENSION STYLE MM ONLY		SCALE 2:1	DESIGN UNITS METRIC	THIRD ANGLE PROJECTION		
			mm	INCH	DRAWN BY MSANDBERG	DATE 05/24/2007	TITLE IMPACT 5 PAIR HEADER RIGHT GUIDED ASSEMBLY SALES DRAWING			
		4 PLACES ± --- ± ---			CHECKED BY JLAURX	DATE 05/24/2007	DOCUMENT NO. SD-76055-003			
		3 PLACES ± --- ± ---			APPROVED BY JLAURX	DATE 2010/10/15				
			ANGULAR ±1/2°		MATERIAL NO.	DOCUMENT NO.		SHEET NO.		
			DRAFT WHERE APPLICABLE MUST REMAIN WITHIN DIMENSIONS		SEE TABLE	SD-76055-003		3 OF 3		
THIS DRAWING CONTAINS INFORMATION THAT IS PROPRIETARY TO MOLEX INCORPORATED AND SHOULD NOT BE USED WITHOUT WRITTEN PERMISSION										