

Excellent Integrated System Limited

Stocking Distributor

Click to view price, real time Inventory, Delivery & Lifecycle Information:

[Molex Connector Corporation](#)
[0761650613](#)

For any questions, you can email us directly:

sales@integrated-circuit.com

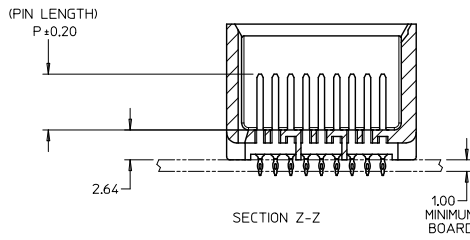
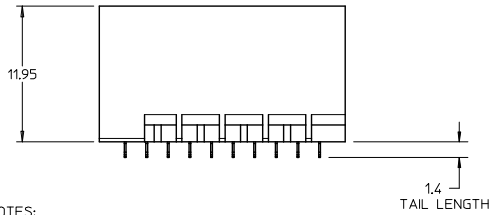
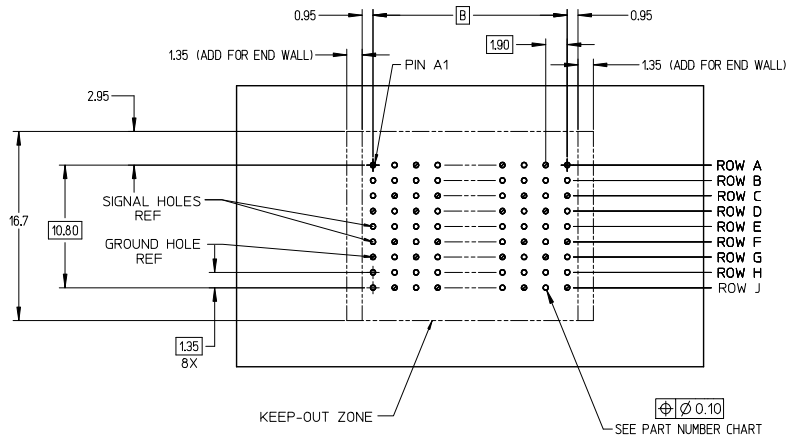
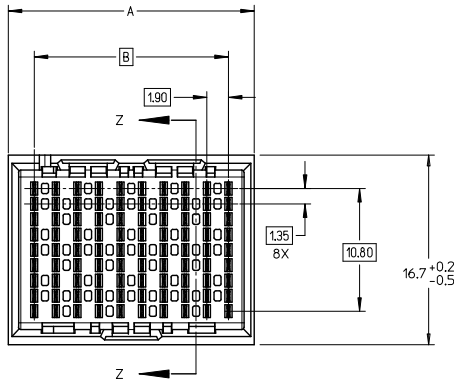

UNGUIDED BACKPLANE HOLE PATTERN (CONNECTOR SIDE) SEE NOTE 9

NOTCH DESIGNATES ROW A

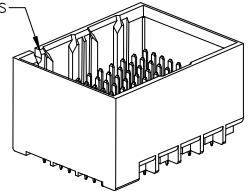

NOTES:

- MATERIALS: HOUSING - LIQUID CRYSTAL POLYMER (LCP)
GLASS-FILLED, UL94V-0
TERMINALS - HIGH PERFORMANCE COPPER ALLOY
- FINISH: 30μ MIN GOLD IN CONTACT AREA.
SELECTIVE TIN ON PCB TAILS.
NICKEL OVERALL.
- REFER TO MOLEX PRODUCT SPECIFICATION PS-76060-999 FOR PERFORMANCE SPECIFICATIONS AND ADDITIONAL PCB INFORMATION.
- THIS PART CONFORMS TO CLASS B REQUIREMENTS OF MOLEX COSMETIC SPEC PS-45499-002.
- PARTS PACKAGED PER PK-70873-7700.
- SEE SHEETS 2 & 3 FOR PART NUMBERS AND BOARD RELATIONSHIPS.
- MATES WITH IMPACT DC SERIES NO. 76170.
- REFER TO MOLEX PCB ROUTING GUIDE AS-76060-990 FOR ANTIPAD AND ROUTING RECOMMENDATIONS.
- *THESE DIMENSIONS REPRESENT THE AREA NEEDED TO ACCOMMODATE CONNECTOR INSERTION AND REPAIR ON THE PC BOARD. THIS IS REFERRED TO AS THE "CONNECTOR KEEP OUT ZONE" AND DOES NOT REPRESENT THE ACTUAL PERIMETER OF THE CONNECTOR. WHEN LAYING OUT A PC BOARD FOR CONNECTORS STACKED TOGETHER, USE A 1.9mm PROGRESSION.*

CONVERT TO LEAD-FREE EC NO: UCP2015-2078 DRAWN: IBARRA 2017/11/28 CHKD: BINGHAM 2017/12/18 APPR: MILLER 2017/12/31	QUALITY SYMBOLS 	GENERAL TOLERANCES (UNLESS SPECIFIED)		DIMENSION STYLE MM ONLY		SCALE 4:1	DESIGN UNITS METRIC	THIRD ANGLE PROJECTION
		4 PLACES ± --- ± ---	DRAWN BY MSANDBERG	DATE 2007/06/18	TITLE IMPACT BP 3 PAIR UNGUIDED ASSEMBLY SALES DRAWING			
		3 PLACES ± --- ± ---	CHECKED BY JLAURX	DATE 2007/06/18				
		2 PLACES ± 0.13 ± --- 1 PLACE ± 0.25 ± --- 0 PLACE ± ±	APPROVED BY JLAURX	DATE 2010/10/15	MATERIAL NO. SEE TABLE	DOCUMENT NO. SD-76165-001	SHEET NO. 1 OF 3	
ANGLULAR ±1/2° DRAFT WHERE APPLICABLE MUST REMAIN WITHIN DIMENSIONS	SIZE C	THIS DRAWING CONTAINS INFORMATION THAT IS PROPRIETARY TO MOLEX INCORPORATED AND SHOULD NOT BE USED WITHOUT WRITTEN PERMISSION						

PART NUMBER TABLE

MATERIAL NUMBER	# OF COLUMNS	# OF DIFF PAIR	DIM 'A'	DIM 'B'	DUAL END WALL OPTION
76165- *32*	6	18	14.1	9.50	
76165- *82*	8	24	17.9	13.30	
76165- *12*	10	30	21.7	17.10	
76165- *62*	16	48	33.1	28.50	

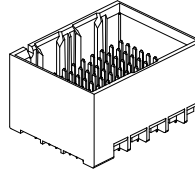

DUAL END
WALL OPTION

MATERIAL NUMBER	# OF COLUMNS	# OF DIFF PAIR	DIM 'A'	DIM 'B'	LEFT END WALL OPTION
76165- *31*	6	18	12.7	9.50	
76165- *81*	8	24	16.5	13.30	
76165- *11*	10	30	20.3	17.10	
76165- *61*	16	48	31.7	28.50	

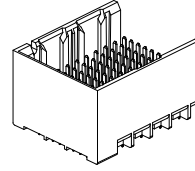

LEFT END
WALL OPTION

MATERIAL NUMBER	# OF COLUMNS	# OF DIFF PAIR	DIM 'A'	DIM 'B'	RIGHT END WALL OPTION
76165- *33*	6	18	12.7	9.50	
76165- *83*	8	24	16.5	13.30	
76165- *13*	10	30	20.3	17.10	
76165- *63*	16	48	31.7	28.50	

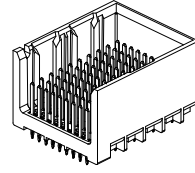

RIGHT END
WALL OPTION

MATERIAL NUMBER	# OF COLUMNS	# OF DIFF PAIR	DIM 'A'	DIM 'B'	OPEN WALL OPTION
76165- *30*	6	18	11.3	9.50	
76165- *80*	8	24	15.1	13.30	
76165- *10*	10	30	18.9	17.10	
76165- *60*	16	48	30.4	28.50	

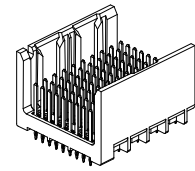

OPEN
WALL OPTION

PART NUMBER LOGIC

76165-****

MODULE TYPE
1 = UNGUIDED, TIN

OF COLUMNS
1 = 10 COL
3 = 6 COL
6 = 16 COL
8 = 8 COL

PIN LENGTH (P)
3 = 4.50 (SHORT COMPLIANT, 0.46±0.05 PTH)
4 = 4.90 (SHORT COMPLIANT, 0.46±0.05 PTH)
5 = 5.50 (SHORT COMPLIANT, 0.46±0.05 PTH)
6 = 4.50 (MICRO COMPLIANT, 0.39±0.05 PTH)
7 = 4.90 (MICRO COMPLIANT, 0.39±0.05 PTH)
8 = 5.50 (MICRO COMPLIANT, 0.39±0.05 PTH)
END WALL OPTIONS
0 = OPEN ENDS
1 = LEFT END WALL
2 = DUAL END WALL
3 = RIGHT END WALL

SEE SHEET 1 EC NO: UCP2013-2078 DRAWN BY: BARBA 2012/11/28 CHKCD: BI INGHAI 2012/12/18 APPR: SMILLER 2012/12/31	QUALITY SYMBOLS ∇=0 ∇=0 ∇=0	GENERAL TOLERANCES (UNLESS SPECIFIED)		DIMENSION STYLE MM ONLY		SCALE 2.5:1	DESIGN UNITS METRIC	THIRD ANGLE PROJECTION
		4 PLACES ± --- ± --- 3 PLACES ± --- ± --- 2 PLACES ± 0.13 ± --- 1 PLACE ± 0.25 ± --- 0 PLACE ± ±	mm INCH DRAWN BY: MSANDBERG DATE: 2007/06/18 CHECKED BY: JLAURX DATE: 2007/06/18 APPROVED BY: JLAURX DATE: 2010/10/15	TITLE IMPACT BP 3 PAIR UNGUIDED ASSEMBLY SALES DRAWING			MATERIAL NO. SEE TABLE	DOCUMENT NO. SD-76165-001
DRAFT WHERE APPLICABLE MUST REMAIN WITHIN DIMENSIONS		THIS DRAWING CONTAINS INFORMATION THAT IS PROPRIETARY TO MOLEX INCORPORATED AND SHOULD NOT BE USED WITHOUT WRITTEN PERMISSION						

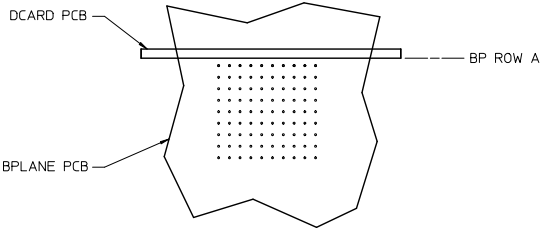

IMPACT 3 PAIR
BOARD RELATIONSHIPS

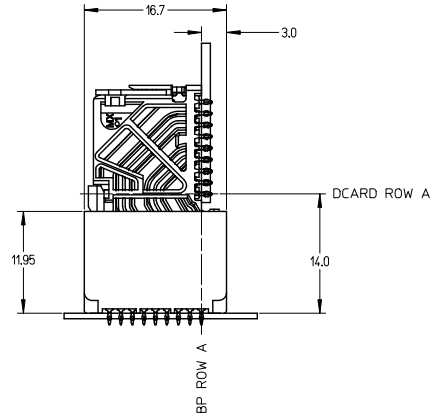
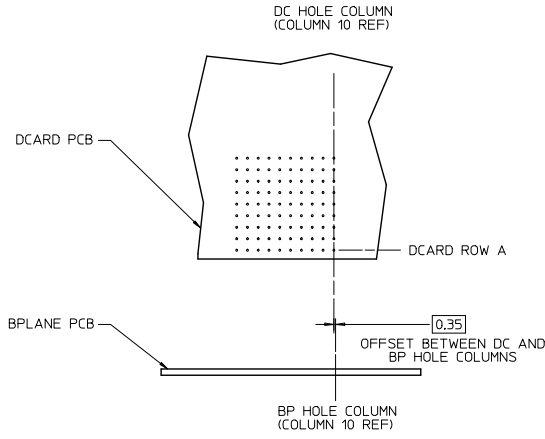

SEE SHEET 1 EC NO: UCP2015-2078 DRAWN BY: TIBARRA 2012/11/28 CHKD: B INGHAM 2012/12/18 APPR: SMILLER 2012/12/21	QUALITY SYMBOLS ∇=0 ∇=0 ∇=0	GENERAL TOLERANCES (UNLESS SPECIFIED)		DIMENSION STYLE MM ONLY		SCALE 3:1	DESIGN UNITS METRIC	THIRD ANGLE PROJECTION		
			mm	INCH	DRAWN BY	DATE	TITLE			
		4 PLACES	± ---	± ---	MSANDBERG	2007/06/18	IMPACT BP 3 PAIR UNGUIDED ASSEMBLY SALES DRAWING			
		3 PLACES	± ---	± ---	CHECKED BY	DATE				
2 PLACES	± 0.13	± ---	JLAURX	2007/06/18	molex DOCUMENT NO. SD-76165-001 SHEET NO. 3 OF 3					
1 PLACE	± 0.25	± ---	APPROVED BY	DATE						
0 PLACE	±	±	JLAURX	2010/10/15						
ANGULAR ±1/2°		MATERIAL NO.		DOCUMENT NO.						
DRAFT WHERE APPLICABLE MUST REMAIN WITHIN DIMENSIONS		SEE TABLE		THIS DRAWING CONTAINS INFORMATION THAT IS PROPRIETARY TO MOLEX INCORPORATED AND SHOULD NOT BE USED WITHOUT WRITTEN PERMISSION						