

## Excellent Integrated System Limited

Stocking Distributor

Click to view price, real time Inventory, Delivery & Lifecycle Information:

[Molex Connector Corporation](#)  
[0781191349](#)

For any questions, you can email us directly:

[sales@integrated-circuit.com](mailto:sales@integrated-circuit.com)

ELV & RoHS COMPLIANT

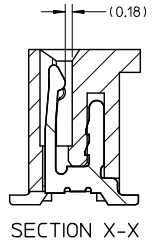
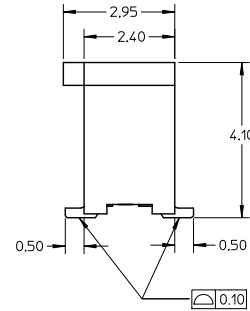
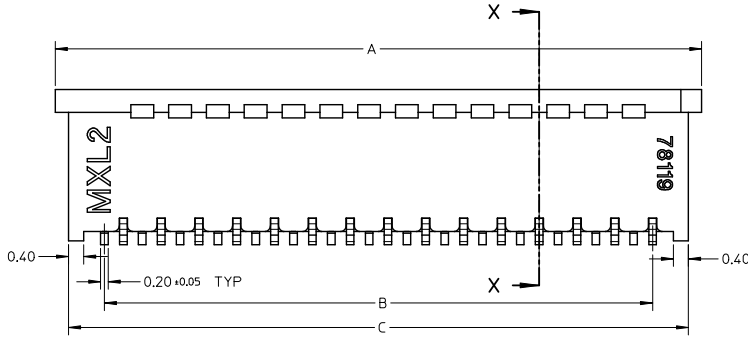
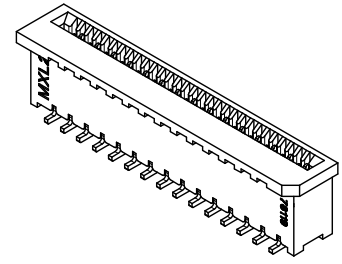
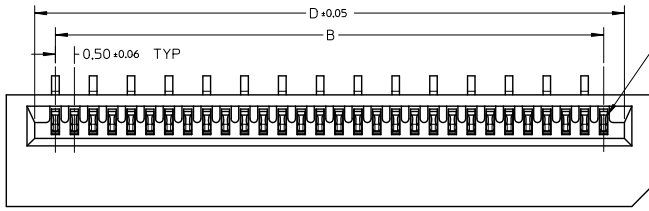

NOTE:

- MATERIAL:  
HOUSING: PA46 GLASS FILLED, UL94V-0, COLOR: NATURAL  
TERMINAL: PHOSPHOR BRONZE
- PLATING: 1) PARTIAL GOLD PLATING OVER NICKEL PLATING OVERALL  
CONTACT POINT: 0.10µm MINIMUM GOLD PLATING  
TAIL POINT : GOLD PLATING  
2) 1-3 µm TIN-BISMUTH OVER NICKEL PLATING OVERALL
- PRODUCT SPECIFICATION: PS-78119-001
- PRODUCT ARE PACKED IN TAPE & REEL.

<b>REVISED</b> EC. NO.: I2013-1512 DRAWN BY: DRWNAOSHII 01 CHKD BY: CHIKOKIYAKASHI APPR: YNUGAWA 2013/06/12 2013/06/12 2013/06/12	QUALITY SYMBOLS	GENERAL TOLERANCES (UNLESS SPECIFIED)	DIMENSION STYLE	SCALE	DESIGN UNITS	THIRD ANGLE PROJECTION
	▽=0	4 PLACES ± --- ± ---	MM ONLY	NTS	METRIC	
	▽=0	3 PLACES ± --- ± ---	DRAWN BY: YLQ1A0	DATE: 2006/04/11	TITLE: 0.50MM PITCH, FPC CONN. NON-ZIF, SMT	
	▽=0	2 PLACES ± 0.15 ± ---	CHECKED BY: BOKOK	DATE: 2006/04/18		
		1 PLACE ± --- ± ---	APPROVED BY: PTLIM	DATE: 2006/04/18		
		0 PLACE ± --- ± ---	MATERIAL NO. SEE TABLE	DOCUMENT NO. SD-78119-001		
		ANGULAR ± 3 °	SIZE: A3	THIS DRAWING CONTAINS INFORMATION THAT IS PROPRIETARY TO MOLEX INCORPORATED AND SHOULD NOT BE USED WITHOUT WRITTEN PERMISSION		
		DRAFT WHERE APPLICABLE MUST REMAIN WITHIN DIMENSIONS				SHEET NO. 1 OF 7

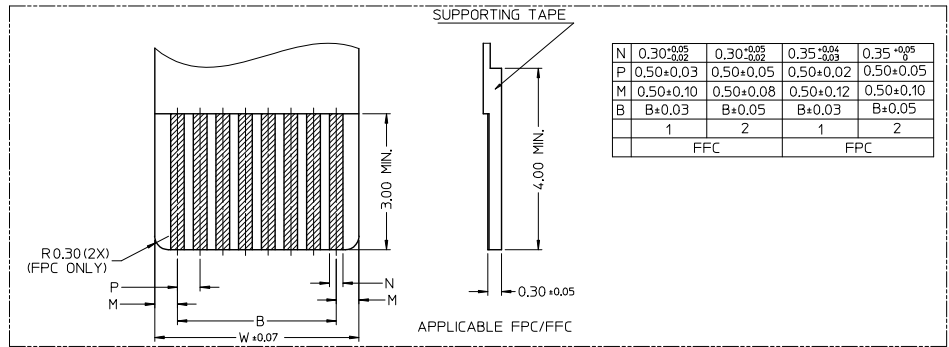
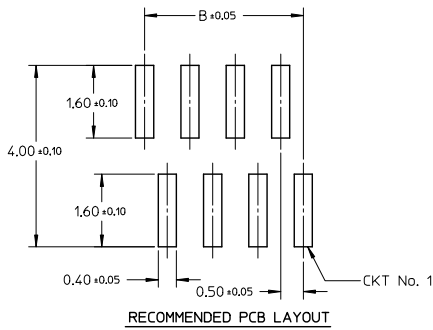

<b>REVISED</b> EC NO: J2013-1512 DRAWN: YOSHII 2013/06/12 CHECKER: TAKAHASHI 2013/06/12 APPR: INOUE 2013/06/12	QUALITY SYMBOLS	GENERAL TOLERANCES (UNLESS SPECIFIED)	DIMENSION STYLE	SCALE	DESIGN UNITS	THIRD ANGLE PROJECTION
	$\nabla=0$ $\nabla=0$ $\nabla=0$	mm    INCH 4 PLACES ± --- ± --- 3 PLACES ± --- ± --- 2 PLACES ± 0.15 ± --- 1 PLACE ± --- ± --- 0 PLACE ±     ± ---	MM ONLY	NTS	METRIC	◎    □ THIRD ANGLE PROJECTION
	DESCRIPTION	ANGULAR ± 3°	DRAWN BY	DATE	TITLE	<b>molex</b> 0.50MM PITCH, FPC CONN. NON-ZIF, SMT
	REV	DRAFT WHERE APPLICABLE MUST REMAIN WITHIN DIMENSIONS	YLO1A0	2006/04/11	DOCUMENT NO.	
A4		SEE TABLE	BOKOK	2006/04/18	SD-78119-001	SHEET NO. 2 OF 7
			APPROVED BY	DATE		
			PTL IM	2006/04/18		
			MATERIAL NO.			
			SIZE			
			A3			
			THIS DRAWING CONTAINS INFORMATION THAT IS PROPRIETARY TO MOLEX INCORPORATED AND SHOULD NOT BE USED WITHOUT WRITTEN PERMISSION			

PARTIAL GOLD PLATING TERMINAL ASSEMBLY PART NUMBERS

ASSY P/N W/O PACKAGING	CKT	DIM A	DIM B	DIM C	DIM D	PLATING TYPE
78119-0108	10	7.10	4.50	6.40	5.60	1
78119-0118	11	7.60	5.00	6.90	6.10	
78119-0128	12	8.10	5.50	7.40	6.60	
78119-0138	13	8.60	6.00	7.90	7.10	
78119-0148	14	9.10	6.50	8.40	7.60	
78119-0158	15	9.60	7.00	8.90	8.10	
78119-0168	16	10.10	7.50	9.40	8.60	
78119-0178	17	10.60	8.00	9.90	9.10	
78119-0188	18	11.10	8.50	10.40	9.60	
78119-0198	19	11.60	9.00	10.90	10.10	
78119-0208	20	12.10	9.50	11.40	10.60	
78119-0218	21	12.60	10.00	11.90	11.10	
78119-0228	22	13.10	10.50	12.40	11.60	
78119-0238	23	13.60	11.00	12.90	12.10	
78119-0248	24	14.10	11.50	13.40	12.60	
78119-0258	25	14.60	12.00	13.90	13.10	
78119-0268	26	15.10	12.50	14.40	13.60	
78119-0278	27	15.60	13.00	14.90	14.10	
78119-0288	28	16.10	13.50	15.40	14.60	
78119-0298	29	16.60	14.00	15.90	15.10	
78119-0308	30	17.10	14.50	16.40	15.60	

ASSY P/N W/O PACKAGING	CKT	DIM A	DIM B	DIM C	DIM D	PLATING TYPE
78119-0318	31	17.60	15.00	16.90	16.10	1
78119-0328	32	18.10	15.50	17.40	16.60	
78119-0338	33	18.60	16.00	17.90	17.10	
78119-0348	34	19.10	16.50	18.40	17.60	
78119-0358	35	19.60	17.00	18.90	18.10	
78119-0368	36	20.10	17.50	19.40	18.60	
78119-0378	37	20.60	18.00	19.90	19.10	
78119-0388	38	21.10	18.50	20.40	19.60	
78119-0398	39	21.60	19.00	20.90	20.10	
78119-0408	40	22.10	19.50	21.40	20.60	

REVISED	EC NO. J2013-1512	2013/06/12
	DRW: YOSHIOI	2013/06/12
	CHK: KATAHASHI	2013/06/12
	APP: TADGAMA	2013/06/23
REV	DESCRIPTION	QUALITY SYMBOLS
A4		$\nabla=0$ $\nabla=0$ $\nabla=0$

GENERAL TOLERANCES (UNLESS SPECIFIED)		DIMENSION STYLE	
		MM ONLY	
		mm	INCH
4 PLACES	± ---	± ---	
3 PLACES	± ---	± ---	
2 PLACES	± 0.15	± ---	
1 PLACE	± ---	± ---	
0 PLACE	±	±	
ANGULAR ± 3°			
DRAFT WHERE APPLICABLE MUST REMAIN WITHIN DIMENSIONS			

DRAWN BY	DATE	TITLE
YLQIAO	2006/04/11	0.50MM PITCH, FPC CONN. NON-ZIF, SMT
CHECKED BY	DATE	
BOKOK	2006/04/18	
APPROVED BY	DATE	
PTL IM	2006/04/18	
MATERIAL NO.	DOCUMENT NO.	
SEE TABLE	SD-78119-001	

SCALE	DESIGN UNITS	THIRD ANGLE PROJECTION
NTS	METRIC	
<b>molex</b>		
SHEET NO.		3 OF 7

10 9 8 7 6 5 4 3 2 1

ELV & RoHS COMPLIANT

TIN-BISMUTH PLATING TERMINAL ASSEMBLY PART NUMBERS

ASSY P/N W/O PACKAGING	CKT	DIM A	DIM B	DIM C	DIM D	PLATING TYPE
78119-0109	10	7.10	4.50	6.40	5.60	2
78119-0119	11	7.60	5.00	6.90	6.10	
78119-0129	12	8.10	5.50	7.40	6.60	
78119-0139	13	8.60	6.00	7.90	7.10	
78119-0149	14	9.10	6.50	8.40	7.60	
78119-0159	15	9.60	7.00	8.90	8.10	
78119-0169	16	10.10	7.50	9.40	8.60	
78119-0179	17	10.60	8.00	9.90	9.10	
78119-0189	18	11.10	8.50	10.40	9.60	
78119-0199	19	11.60	9.00	10.90	10.10	
78119-0209	20	12.10	9.50	11.40	10.60	
78119-0219	21	12.60	10.00	11.90	11.10	
78119-0229	22	13.10	10.50	12.40	11.60	
78119-0239	23	13.60	11.00	12.90	12.10	
78119-0249	24	14.10	11.50	13.40	12.60	
78119-0259	25	14.60	12.00	13.90	13.10	
78119-0269	26	15.10	12.50	14.40	13.60	
78119-0279	27	15.60	13.00	14.90	14.10	
78119-0289	28	16.10	13.50	15.40	14.60	
78119-0299	29	16.60	14.00	15.90	15.10	
78119-0309	30	17.10	14.50	16.40	15.60	

ASSY P/N W/O PACKAGING	CKT	DIM A	DIM B	DIM C	DIM D	PLATING TYPE
78119-0319	31	17.60	15.00	16.90	16.10	2
78119-0329	32	18.10	15.50	17.40	16.60	
78119-0339	33	18.60	16.00	17.90	17.10	
78119-0349	34	19.10	16.50	18.40	17.60	
78119-0359	35	19.60	17.00	18.90	18.10	
78119-0369	36	20.10	17.50	19.40	18.60	
78119-0379	37	20.60	18.00	19.90	19.10	
78119-0389	38	21.10	18.50	20.40	19.60	
78119-0399	39	21.60	19.00	20.90	20.10	
78119-0409	40	22.10	19.50	21.40	20.60	

<b>REVISED</b> EC NO. J2013-1512 DRW: YOSHII 2013/06/12 CHK: K. TAKAHASHI 2013/06/12 APPR: T. INOUE 2013/06/25	<b>QUALITY SYMBOLS</b> $\nabla=0$ $\nabla=0$ $\nabla=0$	<b>GENERAL TOLERANCES (UNLESS SPECIFIED)</b> <table border="1"> <tr><th colspan="2">mm</th><th>INCH</th></tr> <tr><td>4 PLACES</td><td>± ---</td><td>± ---</td></tr> <tr><td>3 PLACES</td><td>± ---</td><td>± ---</td></tr> <tr><td>2 PLACES</td><td>± 0.15</td><td>± ---</td></tr> <tr><td>1 PLACE</td><td>± ---</td><td>± ---</td></tr> <tr><td>0 PLACE</td><td>±</td><td>±</td></tr> </table>	mm		INCH	4 PLACES	± ---	± ---	3 PLACES	± ---	± ---	2 PLACES	± 0.15	± ---	1 PLACE	± ---	± ---	0 PLACE	±	±	<b>DIMENSION STYLE</b> MM ONLY DRAWN BY: YLQIAO DATE: 2006/04/11 CHECKED BY: BOKOK DATE: 2006/04/18 APPROVED BY: PTL IM DATE: 2006/04/18	<b>SCALE</b> NTS <b>DESIGN UNITS</b> METRIC <b>THIRD ANGLE PROJECTION</b>	<b>TITLE</b> 0.50MM PITCH, FPC CONN. NON-ZIF, SMT		<b>DOCUMENT NO.</b> SD-78119-001	<b>SHEET NO.</b> 4 OF 7
			mm		INCH																					
			4 PLACES	± ---	± ---																					
			3 PLACES	± ---	± ---																					
2 PLACES	± 0.15	± ---																								
1 PLACE	± ---	± ---																								
0 PLACE	±	±																								
<b>ANGULAR</b> ± 3° <b>DRAFT WHERE APPLICABLE</b> MUST REMAIN WITHIN DIMENSIONS	<b>MATERIAL NO.</b> SEE TABLE																									
<b>SIZE</b> A3	THIS DRAWING CONTAINS INFORMATION THAT IS PROPRIETARY TO MOLEX INCORPORATED AND SHOULD NOT BE USED WITHOUT WRITTEN PERMISSION																									

9 8 7 6 5 4 3 2 1

EMBOSSED TYPE A

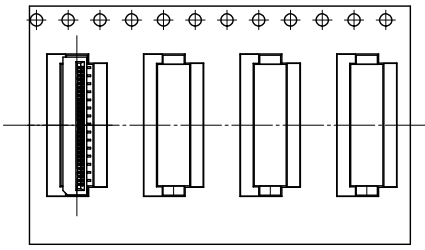

CUSTOMER  
PULL OUT DIRECTION

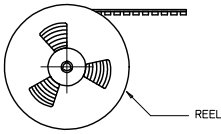

NOTES:

1. LEADER AND TRAILER TAPE

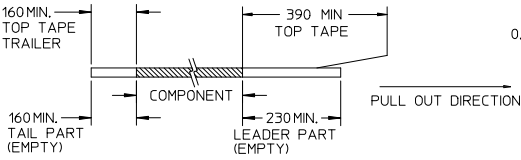

2. PEELING OFF FORCE OF THE TOP TAPE: 20-80gf.  
(PEELING DIRECTION AS SHOWN IN FOLLOWING FIGURE)

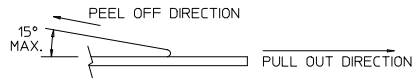

3. PACKAGING STANDARD IS AS PER EIA-481.  
4. TAPE & REEL QUANTITY = 1000 PCS/REEL

EMBOSSED TYPE B

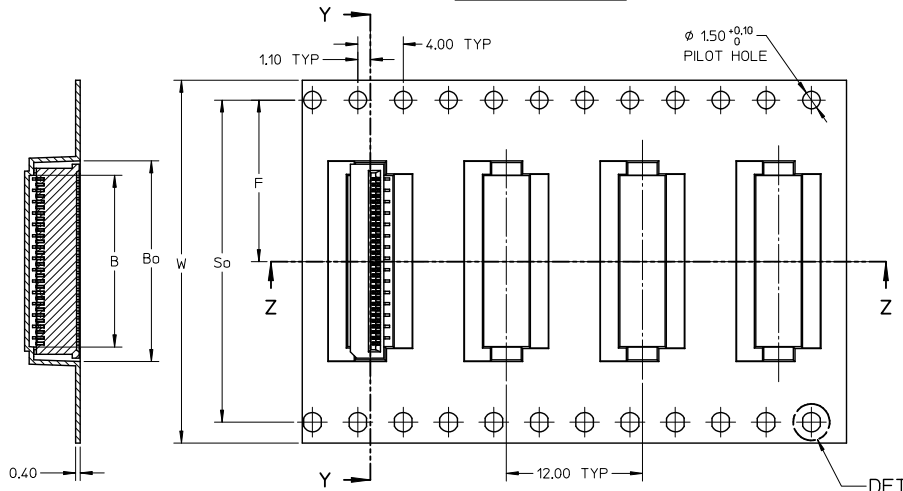

SECTION Y-Y

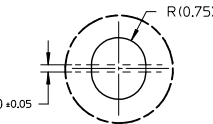

DETAIL 1

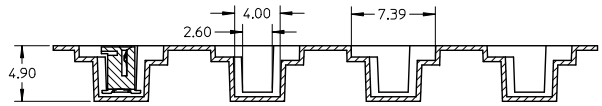

SECTION Z-Z

REVISED EC NO. 12013-1512 DRAWN BY CHIKKOTAKASHI 2013/06/12 APPR. INOYAMA 2013/06/25 A4	QUALITY SYMBOLS	GENERAL TOLERANCES (UNLESS SPECIFIED)	DIMENSION STYLE	SCALE	DESIGN UNITS	THIRD ANGLE PROJECTION	
	$\nabla=0$ $\nabla=0$ $\nabla=0$	mm INCH 4 PLACES ± --- ± --- 3 PLACES ± --- ± --- 2 PLACES ± 0.15 ± --- 1 PLACE ± --- ± --- 0 PLACE ± ±	MM ONLY	NTS	METRIC	DRAWN BY YLO1AO DATE 2006/04/11 CHECKED BY BOKOK DATE 2006/04/18 APPROVED BY PTLIM DATE 2006/04/18	TITLE 0.50MM PITCH, FPC CONN. NON-ZIF, SMT
	ANGULAR ± 3° DRAFT WHERE APPLICABLE MUST REMAIN WITHIN DIMENSIONS	MATERIAL NO. SEE TABLE SIZE A3	DOCUMENT NO. SD-78119-001	SHEET NO. 5 OF 7			
	THIS DRAWING CONTAINS INFORMATION THAT IS PROPRIETARY TO MOLEX INCORPORATED AND SHOULD NOT BE USED WITHOUT WRITTEN PERMISSION						

10 9 8 7 6 5 4 3 2 1

ELV & RoHS COMPLIANT

PARTIAL GOLD PLATING TERMINAL ASSEMBLY PART NUMBERS

ASSY P/N PACKED IN T&R	ASSY P/N W/O PACKAGING	CKT	W	So	F	Bo	B	EMBOSSED TYPE
78119-1108	78119-0108	10	24.00	-	11.50	7.40	5.10	A
78119-1118	78119-0118	11	24.00	-	11.50	7.90	5.60	
78119-1128	78119-0128	12	24.00	-	11.50	8.40	6.10	
78119-1138	78119-0138	13	24.00	-	11.50	8.90	6.60	
78119-1148	78119-0148	14	24.00	-	11.50	9.40	7.10	
78119-1158	78119-0158	15	24.00	-	11.50	9.90	7.60	
78119-1168	78119-0168	16	24.00	-	11.50	10.40	8.10	
78119-1178	78119-0178	17	24.00	-	11.50	10.90	8.60	
78119-1188	78119-0188	18	24.00	-	11.50	11.40	9.10	
78119-1198	78119-0198	19	24.00	-	11.50	11.90	9.60	
78119-1208	78119-0208	20	24.00	-	11.50	12.40	10.10	
78119-1218	78119-0218	21	32.00	28.40	14.20	12.90	10.60	B
78119-1228	78119-0228	22	32.00	28.40	14.20	13.40	11.10	
78119-1238	78119-0238	23	32.00	28.40	14.20	13.90	11.60	
78119-1248	78119-0248	24	32.00	28.40	14.20	14.40	12.10	
78119-1258	78119-0258	25	32.00	28.40	14.20	14.90	12.60	
78119-1268	78119-0268	26	32.00	28.40	14.20	15.40	13.10	
78119-1278	78119-0278	27	32.00	28.40	14.20	15.90	13.60	
78119-1288	78119-0288	28	32.00	28.40	14.20	16.40	14.10	
78119-1298	78119-0298	29	32.00	28.40	14.20	16.90	14.60	
78119-1308	78119-0308	30	32.00	28.40	14.20	17.40	15.10	

ASSY P/N PACKED IN T&R	ASSY P/N W/O PACKAGING	CKT	W	So	F	Bo	B	EMBOSSED TYPE
78119-1318	78119-0318	31	32.00	28.40	14.20	17.90	15.60	B
78119-1328	78119-0328	32	32.00	28.40	14.20	18.40	16.10	
78119-1338	78119-0338	33	32.00	28.40	14.20	18.90	16.60	
78119-1348	78119-0348	34	32.00	28.40	14.20	19.40	17.10	
78119-1358	78119-0358	35	32.00	28.40	14.20	19.90	17.60	
78119-1368	78119-0368	36	32.00	28.40	14.20	20.40	18.10	
78119-1378	78119-0378	37	32.00	28.40	14.20	20.90	18.60	
78119-1388	78119-0388	38	32.00	28.40	14.20	21.40	19.10	
78119-1398	78119-0398	39	44.00	40.40	20.20	21.90	19.60	
78119-1408	78119-0408	40	44.00	40.40	20.20	22.40	20.10	

<b>REVISED</b> EC NO: J2013-1512 DRAWN BY: DR. N. YOSHII 2013/06/12 CHECKED BY: TAKAHASHI 2013/06/12 APPR: INOUE 2013/06/12	QUALITY SYMBOLS √=0 √=0 √=0	GENERAL TOLERANCES (UNLESS SPECIFIED) mm INCH 4 PLACES ± --- ± --- 3 PLACES ± --- ± --- 2 PLACES ± 0.15 ± --- 1 PLACE ± --- ± --- 0 PLACE ± ±	DIMENSION STYLE MM ONLY DRAWN BY: YLQ1A0 DATE: 2006/04/11 CHECKED BY: BOKOK DATE: 2006/04/18 APPROVED BY: PTL IM DATE: 2006/04/18	SCALE NTS	DESIGN UNITS METRIC	THIRD ANGLE PROJECTION
		TITLE 0.50MM PITCH, FPC CONN. NON-ZIF, SMT				
		MATERIAL NO. SEE TABLE				
		DOCUMENT NO. SD-78119-001				

ANGULAR ± 3 °  
 DRAFT WHERE APPLICABLE MUST REMAIN WITHIN DIMENSIONS  
 THIS DRAWING CONTAINS INFORMATION THAT IS PROPRIETARY TO MOLEX INCORPORATED AND SHOULD NOT BE USED WITHOUT WRITTEN PERMISSION  
 SHEET NO. 6 OF 7

9 8 7 6 5 4 3 2 1

10 9 8 7 6 5 4 3 2 1

ELV & RoHS COMPLIANT

TIN-BISMUTH PLATING TERMINAL ASSEMBLY PART NUMBERS

ASSY P/N PACKED IN T&R	ASSY P/N W/O PACKAGING	CKT	W	So	F	Bo	B	EMBOSSED TYPE
78119-1109	78119-0109	10	24.00	-	11.50	7.40	5.10	A
78119-1119	78119-0119	11	24.00	-	11.50	7.90	5.60	
78119-1129	78119-0129	12	24.00	-	11.50	8.40	6.10	
78119-1139	78119-0139	13	24.00	-	11.50	8.90	6.60	
78119-1149	78119-0149	14	24.00	-	11.50	9.40	7.10	
78119-1159	78119-0159	15	24.00	-	11.50	9.90	7.60	
78119-1169	78119-0169	16	24.00	-	11.50	10.40	8.10	
78119-1179	78119-0179	17	24.00	-	11.50	10.90	8.60	
78119-1189	78119-0189	18	24.00	-	11.50	11.40	9.10	
78119-1199	78119-0199	19	24.00	-	11.50	11.90	9.60	
78119-1209	78119-0209	20	24.00	-	11.50	12.40	10.10	
78119-1219	78119-0219	21	32.00	28.40	14.20	12.90	10.60	B
78119-1229	78119-0229	22	32.00	28.40	14.20	13.40	11.10	
78119-1239	78119-0239	23	32.00	28.40	14.20	13.90	11.60	
78119-1249	78119-0249	24	32.00	28.40	14.20	14.40	12.10	
78119-1259	78119-0259	25	32.00	28.40	14.20	14.90	12.60	
78119-1269	78119-0269	26	32.00	28.40	14.20	15.40	13.10	
78119-1279	78119-0279	27	32.00	28.40	14.20	15.90	13.60	
78119-1289	78119-0289	28	32.00	28.40	14.20	16.40	14.10	
78119-1299	78119-0299	29	32.00	28.40	14.20	16.90	14.60	
78119-1309	78119-0309	30	32.00	28.40	14.20	17.40	15.10	

ASSY P/N PACKED IN T&R	ASSY P/N W/O PACKAGING	CKT	W	So	F	Bo	B	EMBOSSED TYPE
78119-1319	78119-0319	31	32.00	28.40	14.20	17.90	15.60	B
78119-1329	78119-0329	32	32.00	28.40	14.20	18.40	16.10	
78119-1339	78119-0339	33	32.00	28.40	14.20	18.90	16.60	
78119-1349	78119-0349	34	32.00	28.40	14.20	19.40	17.10	
78119-1359	78119-0359	35	32.00	28.40	14.20	19.90	17.60	
78119-1369	78119-0369	36	32.00	28.40	14.20	20.40	18.10	
78119-1379	78119-0379	37	32.00	28.40	14.20	20.90	18.60	
78119-1389	78119-0389	38	32.00	28.40	14.20	21.40	19.10	
78119-1399	78119-0399	39	44.00	40.40	20.20	21.90	19.60	
78119-1409	78119-0409	40	44.00	40.40	20.20	22.40	20.10	

<b>REVISED</b> EC NO: J2013-1512 DRAWN BY: 2013/06/12 CHKD BY: TAKAHASHI 2013/06/12 APPR: INOUE 2013/06/23	<b>QUALITY SYMBOLS</b> 	<b>GENERAL TOLERANCES (UNLESS SPECIFIED)</b>		<b>DIMENSION STYLE</b> MM ONLY		SCALE NTS	DESIGN UNITS METRIC	THIRD ANGLE PROJECTION	
		4 PLACES ± --- ± --- 3 PLACES ± --- ± --- 2 PLACES ± 0.15 ± --- 1 PLACE ± --- ± --- 0 PLACE ± ±	mm INCH ± --- ± --- ± --- ± --- ± --- ± --- ± ±	DRAWN BY YLQ1A0	DATE 2006/04/11	TITLE 0.50MM PITCH, FPC CONN. NON-ZIF, SMT			
		ANGULAR ± 3° DRAFT WHERE APPLICABLE MUST REMAIN WITHIN DIMENSIONS		CHECKED BY BOKOK	DATE 2006/04/18	<b>molex</b>			
		MATERIAL NO. SEE TABLE		APPROVED BY PTLIM	DATE 2006/04/18	DOCUMENT NO. SD-78119-001	SHEET NO. 7 OF 7		

9 8 7 6 5 4 3 2 1