

## **Excellent Integrated System Limited**

Stocking Distributor

Click to view price, real time Inventory, Delivery & Lifecycle Information:

[Molex Connector Corporation](#)  
[0850710100](#)

For any questions, you can email us directly:  
[sales@integrated-circuit.com](mailto:sales@integrated-circuit.com)

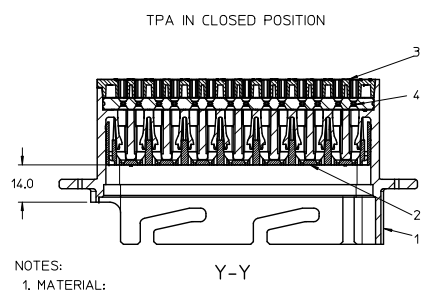
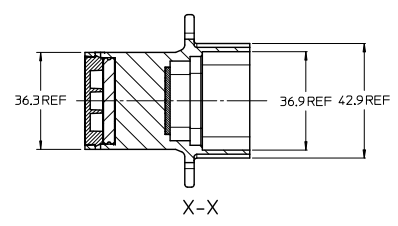
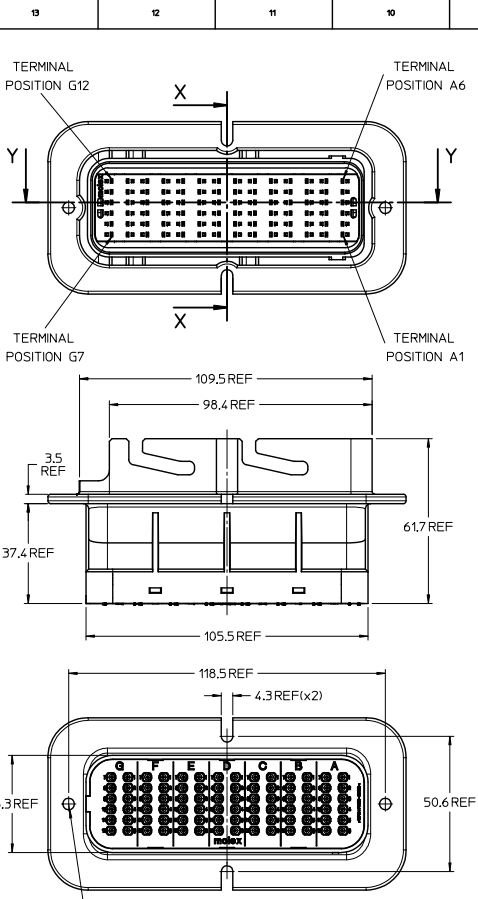

- NOTES:**
1. MATERIAL:  
HOUSINGS: SPS/NYLON BLEND, GLASS FILLED, UL 94 HB  
SEAL: SILICONE RUBBER
  2. MX150 BLADE TERMINALS PER SD-33000-001 TO BE USED WITH THIS ASSEMBLY IN ALL CAVITIES CRIMPED WITH CABLE INSULATION OUTER DIAMETER IN THE RANGE 1.5mm TO 2.7mm
  3. PRODUCT SPECIFICATION: PS-85070-001
  4. PACKAGING SPECIFICATION: PK-85071-001; FRONT COVER SHIPPED IN EITHER CLOSED OR PRE-LOAD POSITION
  5. MATES WITH: SRC RECEPTACLE ASSEMBLY PART NUMBER 850700500 PER SD-85070-500
  6. APPLICATION SPECIFICATION: 850700001 PSA
  7. FLANGE GASKET OPTIONS: REFER TO 850710017 PSD

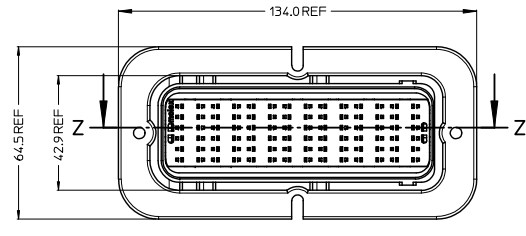
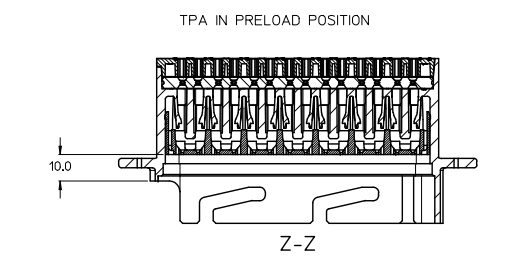
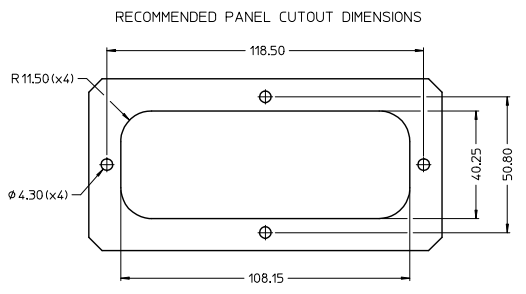

No.	DESCRIPTION	QTY.	COLOUR
4	MALE BACK SEAL	1	RUST RED
3	MALE REAR COVER	1	BLACK
2	MALE FRONT COVER	1	BLACK
1	MALE HOUSING	1	BLACK

BILL OF MATERIAL

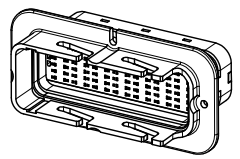

UPDATE TO NOTES	QUALITY SYMBOLS															
EC NO: IFC2016-1052 DRAWN: WALLACE 2016/02/05 CHKD: WALLACE APPR: WALLACE 2016/02/11 REV	<p>GENERAL TOLERANCES (UNLESS SPECIFIED)</p> <table border="1"> <thead> <tr> <th>PLACES</th> <th>mm</th> <th>INCH</th> </tr> </thead> <tbody> <tr> <td>4 PLACES</td> <td>± 0.15</td> <td>± 0.006</td> </tr> <tr> <td>3 PLACES</td> <td>± 0.20</td> <td>± 0.008</td> </tr> <tr> <td>2 PLACES</td> <td>± 0.25</td> <td>± 0.010</td> </tr> <tr> <td>1 PLACE</td> <td>± 0.5</td> <td>± 0.020</td> </tr> </tbody> </table> <p>ANGULAR ± 5°</p> <p>DRAFT WHERE APPLICABLE MUST REMAIN WITHIN DIMENSIONS</p>	PLACES	mm	INCH	4 PLACES	± 0.15	± 0.006	3 PLACES	± 0.20	± 0.008	2 PLACES	± 0.25	± 0.010	1 PLACE	± 0.5	± 0.020
PLACES	mm	INCH														
4 PLACES	± 0.15	± 0.006														
3 PLACES	± 0.20	± 0.008														
2 PLACES	± 0.25	± 0.010														
1 PLACE	± 0.5	± 0.020														

GENERAL TOLERANCES (UNLESS SPECIFIED)		DIMENSION STYLE		SCALE	DESIGN UNITS	THIRD ANGLE PROJECTION
PLACES	mm	INCH	MM ONLY	1:1	METRIC	THIRD ANGLE PROJECTION
4 PLACES	± 0.15	± 0.006	DRAWN BY: CSEBASTIAN	DATE: 2007/07/27	TITLE: SRC MALE 84 PIN BLADE HOUSING ASSEMBLY	
3 PLACES	± 0.20	± 0.008	CHECKED BY: MMUELLER	DATE: 2007/08/21	MATERIAL NO. 850710100	
2 PLACES	± 0.25	± 0.010	APPROVED BY: TREMHOF	DATE: 2007/08/21	DOCUMENT NO. SD-85071-100	
1 PLACE	± 0.5	± 0.020	MATERIAL NO. 850710100		SHEET NO. 1 OF 1	