

Excellent Integrated System Limited

Stocking Distributor

Click to view price, real time Inventory, Delivery & Lifecycle Information:

[Molex Connector Corporation](#)
[1060043085](#)

For any questions, you can email us directly:

sales@integrated-circuit.com

BEZEL P/N	ADAPTER P/N	VERSION	SLEEVE MATERIAL	ADAPTER COLOR	LABEL P/N
106004-3080	106160-0980	1 (ST-SC)	PHOSPHOR BRONZE		
106004-3081	106161-0980		ZIRCONIA	METAL	
106004-3082	106160-0970	2 (FC-SC)	PHOSPHOR BRONZE		
106004-3083	106161-0970		ZIRCONIA		
106004-3084	106171-0160	3 (SC-SC)	PHOSPHOR BRONZE	BLACK	106004-3013
106004-3085	106170-0160		ZIRCONIA	BLACK	
106004-3086	106171-0170		PHOSPHOR BRONZE	RED	
106004-3087	106170-0170		ZIRCONIA	BLUE	
106004-3075	106170-0160				
106004-3088	86181-0000	4(MTP-MTP)	N/A	BLACK	
106004-3089	86181-0007				
106004-3076	106170-0170	3 (SC-SC)	ZIRCONIA	RED	
106004-3093	106171-0160	3 (SC-SC)	PHOSPHOR BRONZE	BLACK	106170-0404

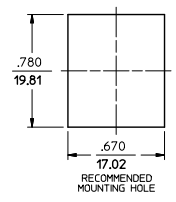
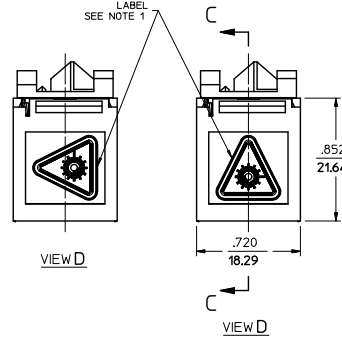
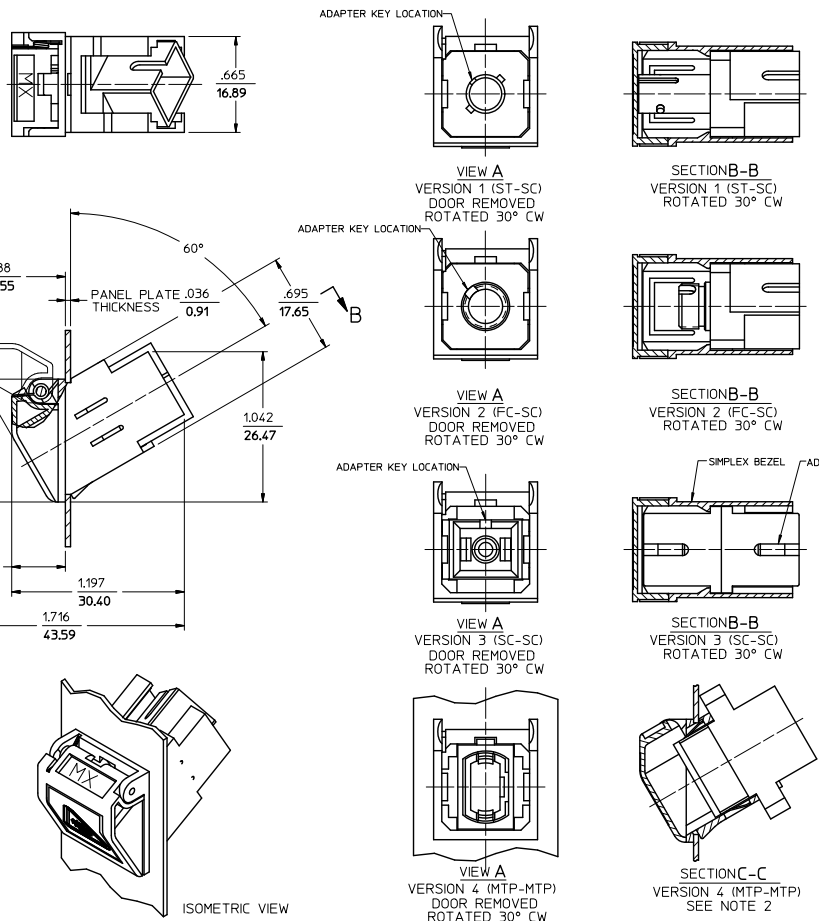

- NOTES:
- LABEL TO BE INSTALLED BY CUSTOMER.
 - MTP-MTP ADAPTER (VERSION 4) TO BE ASSEMBLED BY CUSTOMER, AFTER BEZEL IS INSTALLED IN PANEL CUTOUT.
 - FOR VERSIONS 1, 2, AND 3 ADAPTERS TO BE ASSEMBLED WITH BEZEL. DUST CAPS ON VERSIONS 1, 2, AND 3 TO BE REMOVED ON DOOR SIDE.

ENTER DESCRIPTION EC NO: MF2012-0258 DRAWN BY: CHIKO CHKD: LGUMIN APPR: LGUMIN DATE: 2011/11/14	QUALITY SYMBOLS ▽=0 ▽=0	GENERAL TOLERANCES (UNLESS SPECIFIED)		DIMENSION STYLE IN/MM	SCALE 4:1	DESIGN UNITS INCH	THIRD ANGLE PROJECTION
		4 PLACES ± .005	3 PLACES ± .005	2 PLACES ± .005	1 PLACE ± .005	ANGULAR ± 1/2°	DRAWN BY: PGIBLIN CHECKED BY: DATE: 2005/11/08
DRAFT WHERE APPLICABLE MUST REMAIN WITHIN DIMENSIONS		SEE TABLE		MATERIAL NO.	DOCUMENT NO.	MOLEX INCORPORATED	
				SD-106004-308X	SHEET NO. 1 OF 1		
THIS DRAWING CONTAINS INFORMATION THAT IS PROPRIETARY TO MOLEX INCORPORATED AND SHOULD NOT BE USED WITHOUT WRITTEN PERMISSION							