

Excellent Integrated System Limited

Stocking Distributor

Click to view price, real time Inventory, Delivery & Lifecycle Information:

[Hammond Manufacturing](#)
[1590H](#)

For any questions, you can email us directly:

sales@integrated-circuit.com

Top View of Assembly

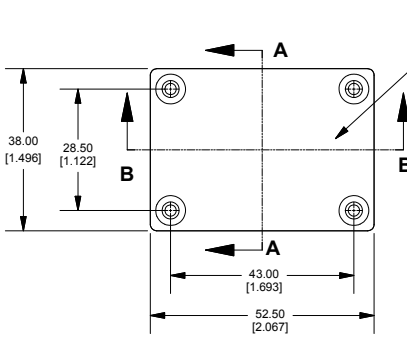

**SECTION A-A
End View of Assembly**

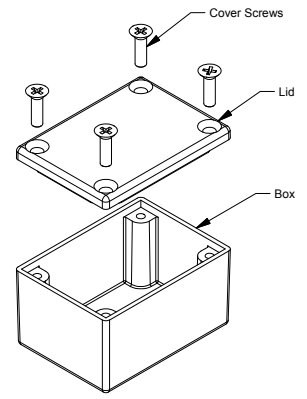
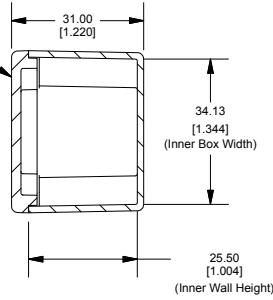

**SECTION B-B
Side View of Assembly**

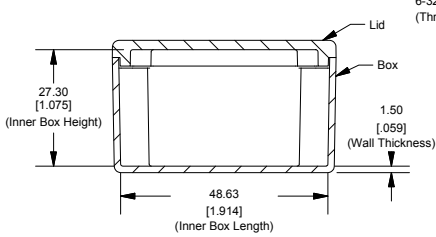

Top View Looking Inside Box

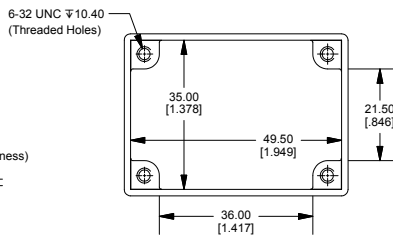

Lid

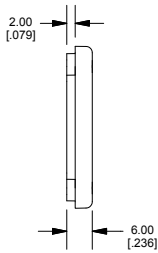
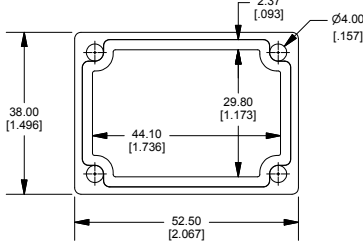

Enclosures can be Factory Modified (Milling, Drilling, Printing etc.)
Contact Factory njm@hammondmfg.com for quotes
Solid models of this enclosure available in STEP or IGES.

NOTE	
Purchased assembly includes box, lid and 4 cover screws. Box and lid are made from Diecast Aluminum Alloy. Silicone Gasket supplied with liquid resistant enclosure.	
PART NUMBERS	
1590H Enclosure	
Natural Finish Enclosure	1590H
Black Textured Enclosure	1590HBK
1590W Enclosure (Silicone Gasket)	
Natural Finish Enclosure	1590WH
Black Textured Enclosure	1590WHBK
ACCESSORIES	
Recommended Torque: 75 ozf.in / 55 cN.m	
Liquid Resistant Cover Screws	
Stainless Steel Cover Screws (Pkg 100)	1590WMS100
[6-32 x 1/2" With O-Ring]	1590WMS100BK
Black Stainless Steel Cover Screws (Pkg 100)	1590WMS100BK
[6-32 x 1/2" With O-Ring]	
Standard Cover Screws	
Plated Cover Screws (Pkg 100)	1590MS100
[6-32 x 1/2"]	
Black Cover Screws (Pkg 100)	1590MS100BK
[6-32 x 1/2"]	

Dimensions:
mm
[inches]

**HAMMOND
MANUFACTURING™**

1590H

www.hammondmfg.com