

Excellent Integrated System Limited

Stocking Distributor

Click to view price, real time Inventory, Delivery & Lifecycle Information:

[FCI](#)
[10118073-500A010LF](#)

For any questions, you can email us directly:
sales@integrated-circuit.com

Copyright FCI.

FCI
FCIconnect.com

1 | 2

3 |

4

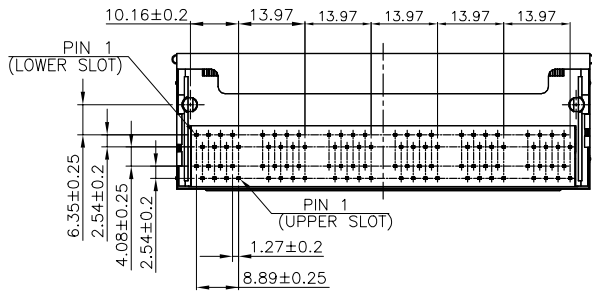
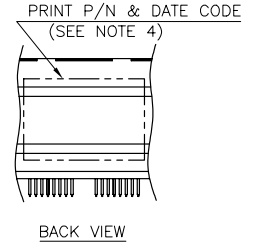
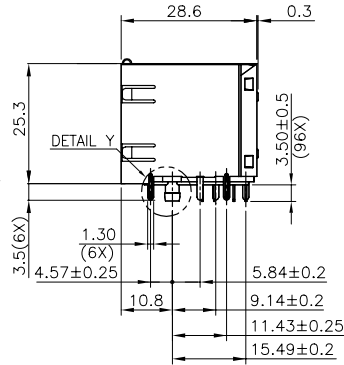
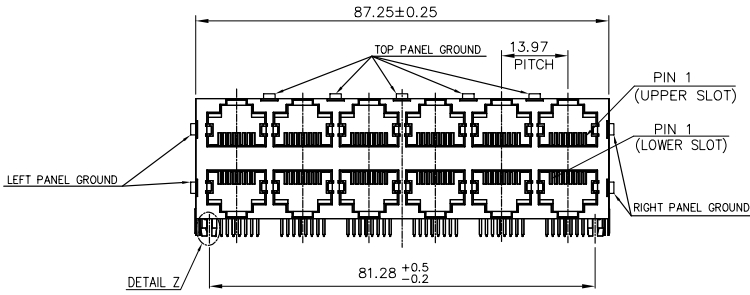
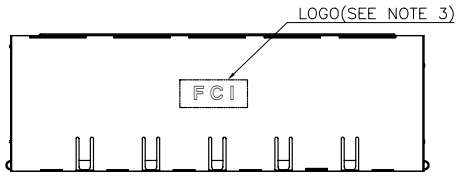

mat'l. code		surface ASME Y14.5		tolerance ASME Y14.5		projection		product family	
ltr	ecn no	dr	date	tolerances unless otherwise specified		MM [INCH]		GANGED M JACK	
A	WL	11/04/11		angles	X.X±0.25			title	
B	EX-N-16390	LQ	11/28/13	X'±1'	X.XX±0.13			CAT 3 MULTIPORT STACKED	
				X.XXX±0.05		scale		2x6 WITH SHIELD, W/O LED	
						FCI		dwg no	
								10118073	
								sheet 1 of 3	
								A4	
								type	
								CUSTOMER Drawing	
sheet index	revision sheet	B 1	B 2	B 3					

form: A4mmXLc

1 |

2 |

3 |

4

PDS: Rev :B

STATUS:Released

Printed: Jan 07, 2014

Copyright FCI.



1 | 2

3 |

4

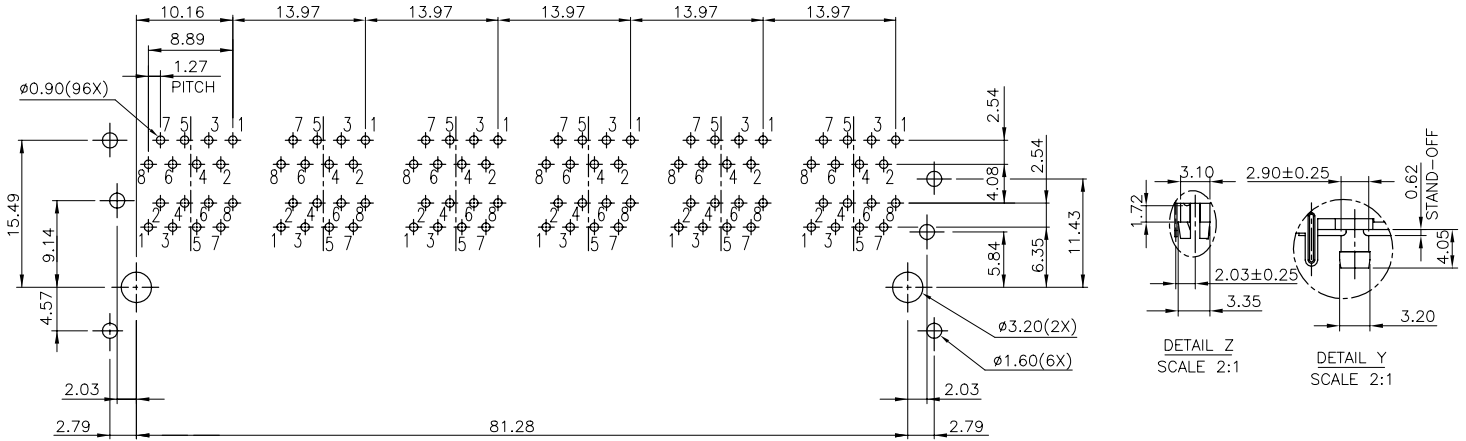

RECOMMENDED PCB LAYOUT
 RECOMMENDED PCB THICKNESS: 1.6mm
 TOLERANCE:±0.05mm (TOP VIEW)

mat'l. code		surface	tolerance	projection	product family	
ltr		ASME Y14.5	ASME Y14.5	 MM [INCH]	GANGED M JACK	
ecn	no	tolerances unless otherwise specified			title	
B		angle	X.X±0.25		CAT 3 MULTIPOINT STACKED	
		size	X.XX±0.13	scale	2x6 WITH SHIELD, W/O LED	
		X'±1'	X.XXX±0.05		dwg no	
		dr	WENDY CHEN 05/03/11		sheet 2 of 3	
		enr	WENDY CHEN 05/03/11		10118073	A4
		chr	WENDY CHEN 05/03/11		type	CUSTOMER Drawing
		appd	GARY HSIEH 05/03/11			
sheet index	revision sheet					

form: A4mmXLc

1 |

2 |

3 |

4

PDS: Rev :B

STATUS:Released

Printed: Jan 07, 2014



1 | 2

3 |

4

NOTE:

1. MATERIAL:
HOUSING & INNER HOUSING & COVER:
HIGH TEMPERATURE THERMOPLASTIC, UL94V-0, COLOR: BLACK.
CONTACTS: COPPER ALLOY.
SHIELD: COPPER ALLOY.
INNER SHIELD: COPPER ALLOY.
2. FINISH:
CONTACTS: 50u" MIN. NICKEL UNDER PLATED OVER ALL.
SELECTIVE GOLD PLATED ON CONTACT AREA,
1u" GOLD PLATED ON SOLDER TAIL.
SHIELD & INNER SHIELD: 20u" MIN. NICKEL OVER ALL.
3. LASER MARK FCI LOGO ON THE TOP OF SHIELD.
4. "DATE CODE" DESCRIPTION:

XX	XX	
		WEEK
YEAR (EX. : 10--2010)		
5. PRODUCT PERFORMANCE PER SPEC. : GS-12-0990.
6. PACKING SPEC. : GS-14-2170.
7. THIS PRODUCT MEETS THE EUROPEAN UNION DIRECTIVE AS DESCRIBED IN GS-22-008.
8. THE HOUSING WILL WITHSTAND EXPOSURE TO 260°C PEAK TEMPERATURE FOR 5 SECONDS IN A WAVE SOLDER APPLICATION WITH A CIRCUIT BOARD.

9. PART NUMBER DESCRIPTION:

- 10118073-X X X X X X X LF
- LEAD FREE
 - 0 : RESERVED (NOT USED)
 - PACKAGING
 - 1 : TRAY
 - OPTIONAL BACK SHIELD TAB
 - 0 : WITHOUT BACK SHIELD TAB
 - OPTIONAL RIGHT / LEFT SHIELD TAB
 - A : SHIELD TAB WITH INNER SHIELD
 - B : SHIELD TAB WITHOUT INNER SHIELD
 - OPTIONAL PANEL GROUND
 - 0 : WITHOUT PANEL GROUND
 - 3 : 3 SIDES(TOP/RIGHT/LEFT)PANEL GROUND
 - LED COLOR
 - 0 : WITHOUT LED
 - CONTACT AREA PLATING
 - 1 : 15u" GOLD PLATING
 - 2 : 30u" GOLD PLATING
 - 5 : 1u" GOLD FLASH PLATING

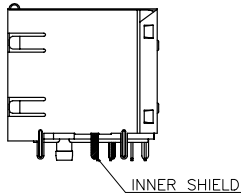

10118073-XXXAXXXLF
(WITH INNER SHIELD)

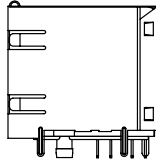

10118073-XXXBXXLLF
(WITHOUT INNER SHIELD)

mat'l. code		surface ASME Y14.5	tolerance ASME Y14.5	projection	product family
ltr	ecn no	dr	date	tolerances unless otherwise specified	GANGED MJACK
B				angles	title
				X.X±0.25	CAT 3 MULTIPORT STACKED
				X.XX±0.13	2x6 WITH SHIELD, W/O LED
				X'±1'	X.XXX±0.05
				scale	MM [INCH]
				dr	WENDY CHEN 05/03/11
				enr	WENDY CHEN 05/03/11
				chr	WENDY CHEN 05/03/11
				appd	GARY HSIEH 05/03/11
sheet index	revision sheet				FCJ
					dwg no
					10118073
					sheet 3 of 3
					size A4
					type CUSTOMER Drawing