

Excellent Integrated System Limited

Stocking Distributor

Click to view price, real time Inventory, Delivery & Lifecycle Information:

[Molex Connector Corporation](#)
[0191930358](#)

For any questions, you can email us directly:

sales@integrated-circuit.com

DRWG. NO. CDK390

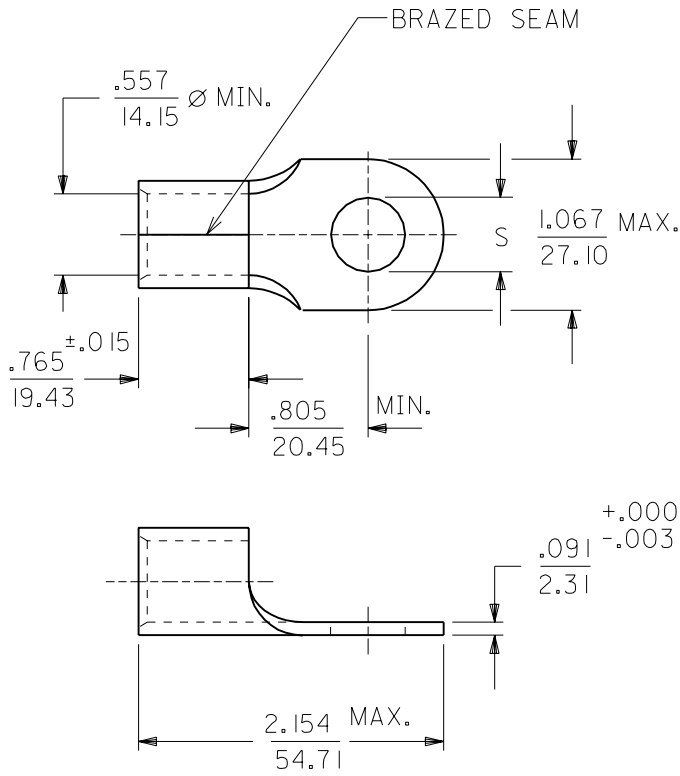

MATERIAL: COPPER
PLATING: TIN

PART NO.	STUD SIZE	±.003 "S"
K-390-56	5/16	.328
K-390-38	3/8	.390
K-390-76	7/16	.453
K-390-12	1/2	.515
K-390-58	5/8	.656
K-390-34	3/4	.781

WIRE SIZE: 3/0 AWG
95 MM²

REVISE ONLY ON CAD SYSTEM

TITLE
RING TONGUE TERMINAL
VERSAKRIMP
3/0 AWG

DRWG. BY EMF
CHK'D. BY JM
APP'D. BY FP
SCALE 1:1

molex ETC INC.
PINELLAS PARK, FLA. 34665 U.S.A.
PART NO. SEE CHART
FILE NAME CDK390

SHEET NO. DATE 12/01/93
DRWG. NO. CDK390
THIS DRAWING CONTAINS INFORMATION THAT IS PROPRIETARY TO MOLEX-ETC INC. AND SHOULD NOT BE USED WITHOUT WRITTEN PERMISSION.
DIV. SIZE A

6

5

4

3

2

1