

Excellent Integrated System Limited

Stocking Distributor

Click to view price, real time Inventory, Delivery & Lifecycle Information:

[ON Semiconductor](#)
[NJVMJD2955T4G](#)

For any questions, you can email us directly:

sales@integrated-circuit.com

MJD2955 (PNP), MJD3055 (NPN)

Complementary Power Transistors

DPAK for Surface Mount Applications

Designed for general purpose amplifier and low speed switching applications.

Features

- Lead Formed for Surface Mount Applications in Plastic Sleeves (No Suffix)
- Straight Lead Version in Plastic Sleeves ("-1" Suffix)
- Electrically Similar to MJE2955 and MJE3055
- High Current Gain-Bandwidth Product
- Epoxy Meets UL 94 V-0 @ 0.125 in
- NJV Prefix for Automotive and Other Applications Requiring Unique Site and Control Change Requirements; AEC-Q101 Qualified and PPAP Capable
- These Devices are Pb-Free and are RoHS Compliant

MAXIMUM RATINGS

Rating	Symbol	Max	Unit
Collector-Emitter Voltage	V_{CEO}	60	Vdc
Collector-Base Voltage	V_{CB}	70	Vdc
Emitter-Base Voltage	V_{EB}	5	Vdc
Collector Current	I_C	10	Adc
Base Current	I_B	6	Adc
Total Power Dissipation @ $T_C = 25^\circ\text{C}$ Derate above 25°C	P_D^\dagger	20 0.16	W W/ $^\circ\text{C}$
Total Power Dissipation (Note 1) @ $T_A = 25^\circ\text{C}$ Derate above 25°C	P_D	1.75 0.014	W W/ $^\circ\text{C}$
Operating and Storage Junction Temperature Range	T_J, T_{stg}	-55 to +150	$^\circ\text{C}$
ESD - Human Body Model	HBM	3B	V
ESD - Machine Model	MM	C	V

Stresses exceeding Maximum Ratings may damage the device. Maximum Ratings are stress ratings only. Functional operation above the Recommended Operating Conditions is not implied. Extended exposure to stresses above the Recommended Operating Conditions may affect device reliability.

†Safe Area Curves are indicated by Figure 1. Both limits are applicable and must be observed.

1. These ratings are applicable when surface mounted on the minimum pad sizes recommended.



ON Semiconductor®

<http://onsemi.com>

SILICON POWER TRANSISTORS 10 AMPERES 60 VOLTS, 20 WATTS

COMPLEMENTARY

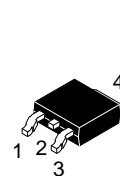
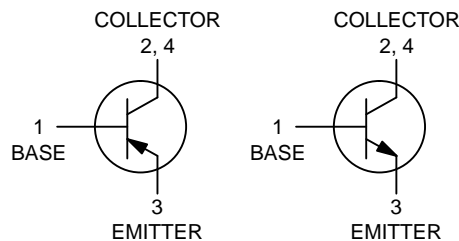

DPAK
CASE 369C
STYLE 1

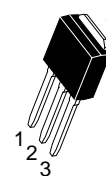

IPAK
CASE 369D
STYLE 1

MARKING DIAGRAMS

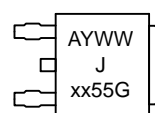

DPAK



IPAK

- A = Assembly Location
- Y = Year
- WW = Work Week
- Jxx55 = Device Code
x = 29 or 30
- G = Pb-Free Package

ORDERING INFORMATION

See detailed ordering and shipping information in the package dimensions section on page 5 of this data sheet.

MJD2955 (PNP), MJD3055 (NPN)

THERMAL CHARACTERISTICS

Characteristic	Symbol	Max	Unit
Thermal Resistance, Junction-to-Case	$R_{\theta JC}$	6.25	$^{\circ}\text{C/W}$
Thermal Resistance, Junction-to-Ambient (Note 2)	$R_{\theta JA}$	71.4	$^{\circ}\text{C/W}$

2. These ratings are applicable when surface mounted on the minimum pad sizes recommended.

ELECTRICAL CHARACTERISTICS ($T_C = 25^{\circ}\text{C}$ unless otherwise noted)

Characteristic	Symbol	Min	Max	Unit
----------------	--------	-----	-----	------

OFF CHARACTERISTICS

Collector-Emitter Sustaining Voltage (Note 3) ($I_C = 30\text{ mAdc}$, $I_B = 0$)	$V_{CEO(sus)}$	60	-	Vdc
Collector Cutoff Current ($V_{CE} = 30\text{ Vdc}$, $I_B = 0$)	I_{CEO}	-	50	μAdc
Collector Cutoff Current ($V_{CE} = 70\text{ Vdc}$, $V_{EB(off)} = 1.5\text{ Vdc}$) ($V_{CE} = 70\text{ Vdc}$, $V_{EB(off)} = 1.5\text{ Vdc}$, $T_C = 150^{\circ}\text{C}$)	I_{CEX}	-	0.02 2	mAdc
Collector Cutoff Current ($V_{CB} = 70\text{ Vdc}$, $I_E = 0$) ($V_{CB} = 70\text{ Vdc}$, $I_E = 0$, $T_C = 150^{\circ}\text{C}$)	I_{CBO}	-	0.02 2	mAdc
Emitter Cutoff Current ($V_{BE} = 5\text{ Vdc}$, $I_C = 0$)	I_{EBO}	-	0.5	mAdc

ON CHARACTERISTICS

DC Current Gain (Note 3) ($I_C = 4\text{ Adc}$, $V_{CE} = 4\text{ Vdc}$) ($I_C = 10\text{ Adc}$, $V_{CE} = 4\text{ Vdc}$)	h_{FE}	20 5	100 -	-
Collector-Emitter Saturation Voltage (Note 3) ($I_C = 4\text{ Adc}$, $I_B = 0.4\text{ Adc}$) ($I_C = 10\text{ Adc}$, $I_B = 3.3\text{ Adc}$)	$V_{CE(sat)}$	-	1.1 8	Vdc
Base-Emitter On Voltage (Note 3) ($I_C = 4\text{ Adc}$, $V_{CE} = 4\text{ Vdc}$)	$V_{BE(on)}$	-	1.8	Vdc

DYNAMIC CHARACTERISTICS

Current-Gain - Bandwidth Product ($I_C = 500\text{ mAdc}$, $V_{CE} = 10\text{ Vdc}$, $f = 500\text{ kHz}$)	f_T	2	-	MHz
---	-------	---	---	-----

3. Pulse Test: Pulse Width $\leq 300\ \mu\text{s}$, Duty Cycle $\leq 2\%$.

MJD2955 (PNP), MJD3055 (NPN)

TYPICAL CHARACTERISTICS

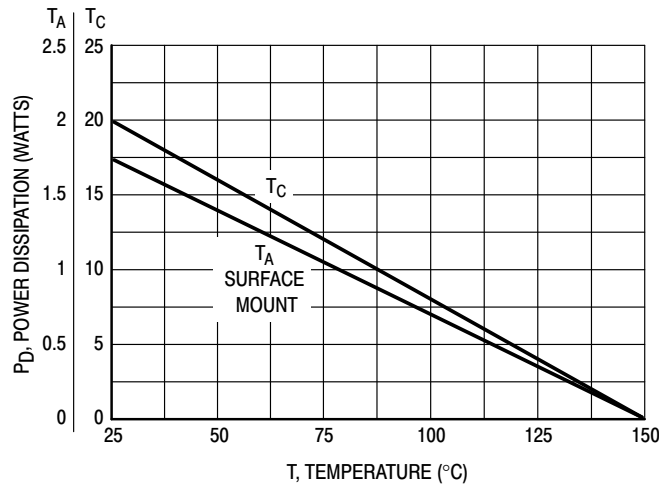

Figure 1. Power Derating

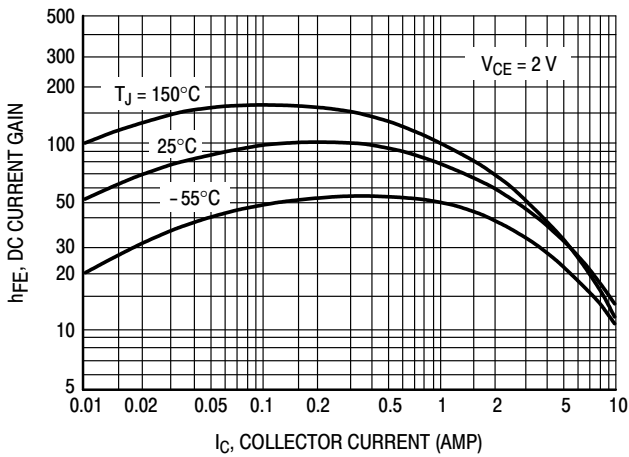

Figure 2. DC Current Gain

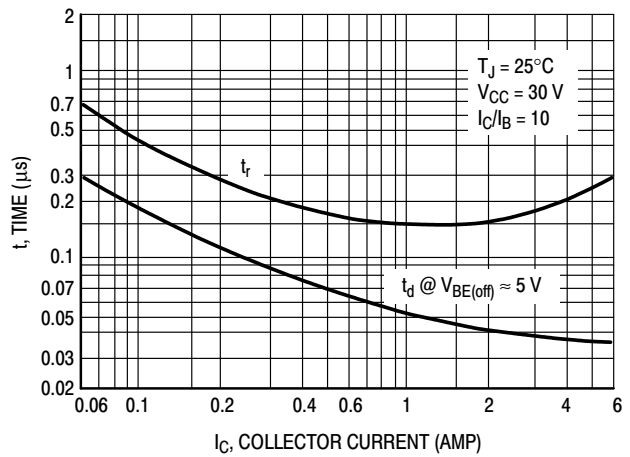

Figure 3. Turn-On Time

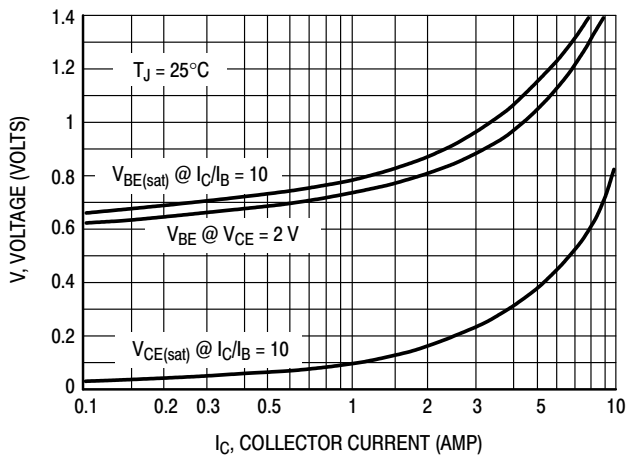

Figure 4. "On" Voltages, MJD3055

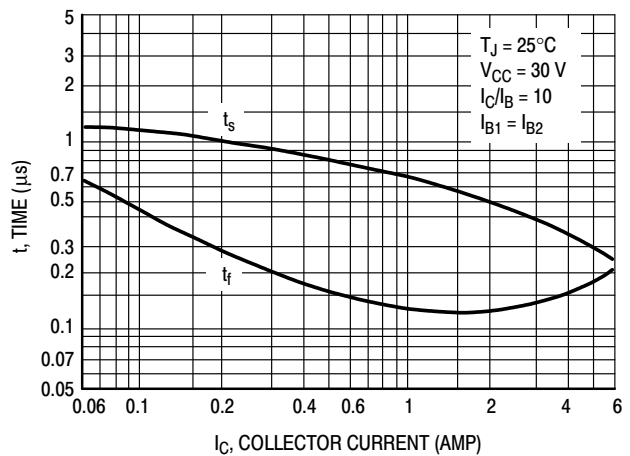

Figure 5. Turn-Off Time

MJD2955 (PNP), MJD3055 (NPN)

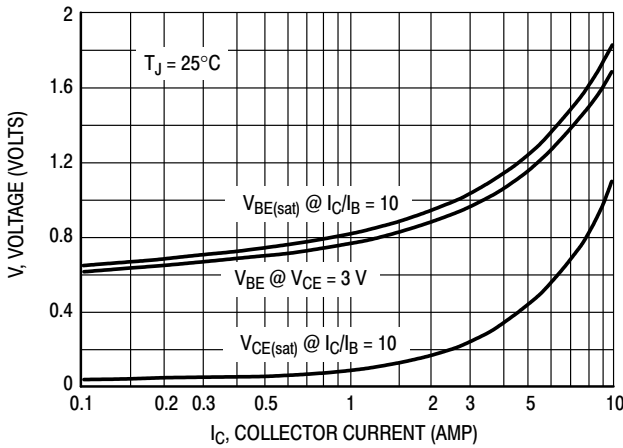
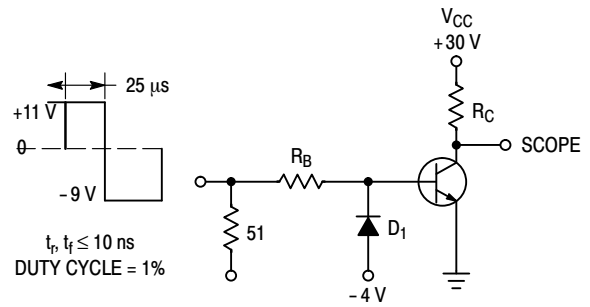

Figure 6. "On" Voltages, MJD2955



R_B and R_C VARIED TO OBTAIN DESIRED CURRENT LEVELS

D_1 MUST BE FAST RECOVERY TYPE, eg:
1N5825 USED ABOVE $I_B \approx 100$ mA
MSD6100 USED BELOW $I_B \approx 100$ mA

Figure 7. Switching Time Test Circuit

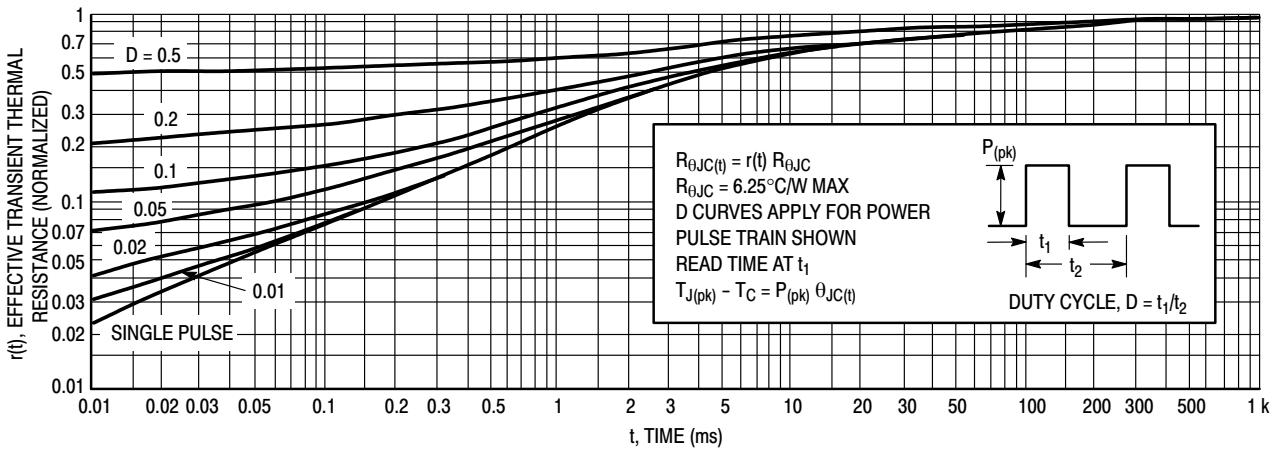

Figure 8. Thermal Response

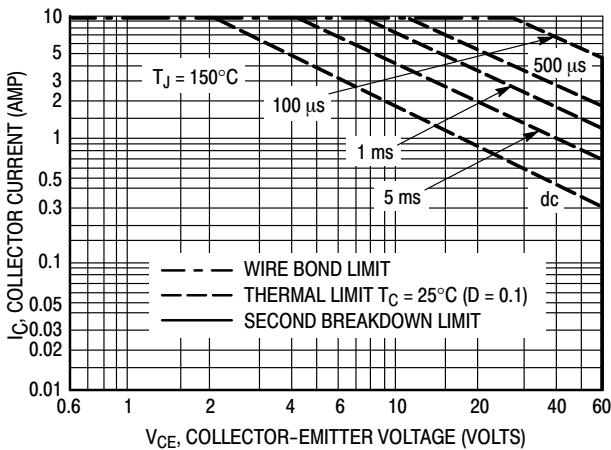

Figure 9. Maximum Forward Bias Safe Operating Area

Forward Bias Safe Operating Area Information

There are two limitations on the power handling ability of a transistor: average junction temperature and second breakdown. Safe operating area curves indicate $I_C - V_{CE}$ limits of the transistor that must be observed for reliable operation; i.e., the transistor must not be subjected to greater dissipation than the curves indicate.

The data of Figure 9 is based on $T_{J(pk)} = 150^\circ\text{C}$; T_C is variable depending on conditions. Second breakdown pulse limits are valid for duty cycles to 10% provided $T_{J(pk)} \leq 150^\circ\text{C}$. $T_{J(pk)}$ may be calculated from the data in Figure 8. At high case temperatures, thermal limitations will reduce the power that can be handled to values less than the limitations imposed by second breakdown.

MJD2955 (PNP), MJD3055 (NPN)

ORDERING INFORMATION

Device	Package Type	Package	Shipping†
MJD2955G	DPAK (Pb-Free)	369C	75 Units / Rail
MJD2955-1G	IPAK (Pb-Free)	369D	75 Units / Rail
MJD2955T4G	DPAK (Pb-Free)	369C	2,500 / Tape & Reel
NJVMJD2955T4G*	DPAK (Pb-Free)	369C	2,500 / Tape & Reel
MJD3055G	DPAK (Pb-Free)	369C	75 Units / Rail
MJD3055T4G	DPAK (Pb-Free)	369C	2,500 / Tape & Reel
NJVMJD3055T4G*	DPAK (Pb-Free)	369C	2,500 / Tape & Reel

†For information on tape and reel specifications, including part orientation and tape sizes, please refer to our Tape and Reel Packaging Specifications Brochure, BRD8011/D.

*NJV Prefix for Automotive and Other Applications Requiring Unique Site and Control Change Requirements; AEC-Q101 Qualified and PPAP Capable

MJD2955 (PNP), MJD3055 (NPN)

PACKAGE DIMENSIONS

DPAK (SINGLE GAUGE)

CASE 369C

ISSUE D

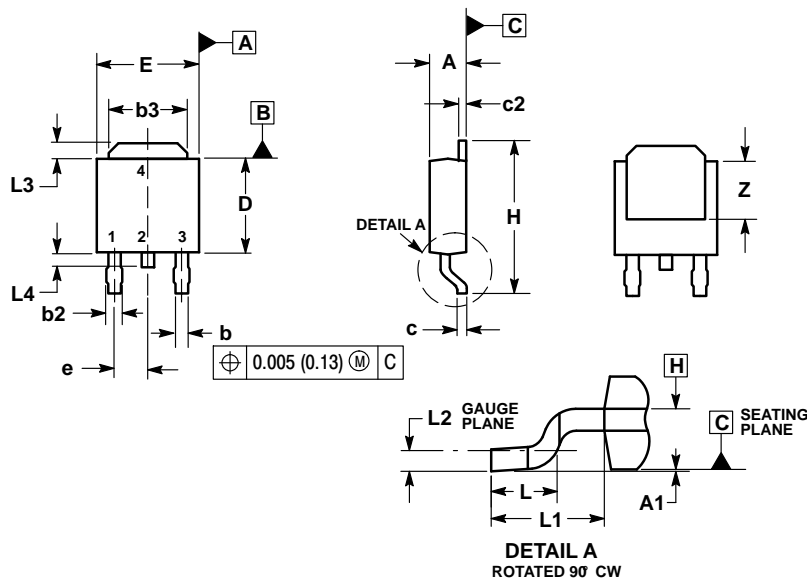

NOTES:

1. DIMENSIONING AND TOLERANCING PER ASME Y14.5M, 1994.
2. CONTROLLING DIMENSION: INCHES.
3. THERMAL PAD CONTOUR OPTIONAL WITHIN DIMENSIONS b3, L3 and Z.
4. DIMENSIONS D AND E DO NOT INCLUDE MOLD FLASH, PROTRUSIONS, OR BURRS. MOLD FLASH, PROTRUSIONS, OR GATE BURRS SHALL NOT EXCEED 0.006 INCHES PER SIDE.
5. DIMENSIONS D AND E ARE DETERMINED AT THE OUTERMOST EXTREMES OF THE PLASTIC BODY.
6. DATUMS A AND B ARE DETERMINED AT DATUM PLANE H.

DIM	INCHES		MILLIMETERS	
	MIN	MAX	MIN	MAX
A	0.086	0.094	2.18	2.38
A1	0.000	0.005	0.00	0.13
b	0.025	0.035	0.63	0.89
b2	0.030	0.045	0.76	1.14
b3	0.180	0.215	4.57	5.46
c	0.018	0.024	0.46	0.61
c2	0.018	0.024	0.46	0.61
D	0.235	0.245	5.97	6.22
E	0.250	0.265	6.35	6.73
e	0.090 BSC		2.29 BSC	
H	0.370	0.410	9.40	10.41
L	0.055	0.070	1.40	1.78
L1	0.108 REF		2.74 REF	
L2	0.020 BSC		0.51 BSC	
L3	0.035	0.050	0.89	1.27
L4	---	0.040	---	1.01
Z	0.155	---	3.93	---

STYLE 1:

1. BASE
2. COLLECTOR
3. EMITTER
4. COLLECTOR

SOLDERING FOOTPRINT*

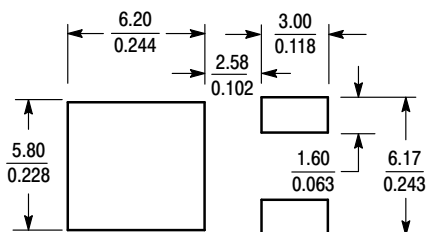

SCALE 3:1 (mm/inches)

*For additional information on our Pb-Free strategy and soldering details, please download the ON Semiconductor Soldering and Mounting Techniques Reference Manual, SOLDERRM/D.

MJD2955 (PNP), MJD3055 (NPN)

PACKAGE DIMENSIONS

IPAK
CASE 369D
ISSUE C

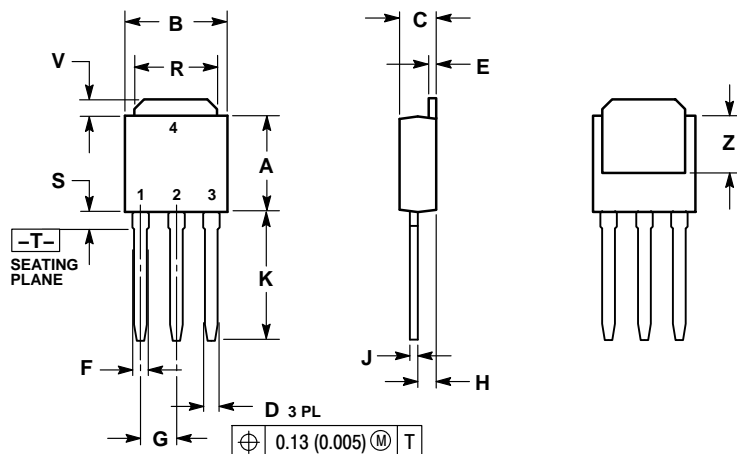

- NOTES:
1. DIMENSIONING AND TOLERANCING PER ANSI Y14.5M, 1982.
2. CONTROLLING DIMENSION: INCH.

DIM	INCHES		MILLIMETERS	
	MIN	MAX	MIN	MAX
A	0.235	0.245	5.97	6.35
B	0.250	0.265	6.35	6.73
C	0.086	0.094	2.19	2.38
D	0.027	0.035	0.69	0.88
E	0.018	0.023	0.46	0.58
F	0.037	0.045	0.94	1.14
G	0.090 BSC		2.29 BSC	
H	0.034	0.040	0.87	1.01
J	0.018	0.023	0.46	0.58
K	0.350	0.380	8.89	9.65
R	0.180	0.215	4.45	5.45
S	0.025	0.040	0.63	1.01
V	0.035	0.050	0.89	1.27
Z	0.155	---	3.93	---

- STYLE 1:
PIN 1. BASE
2. COLLECTOR
3. EMITTER
4. COLLECTOR

ON Semiconductor and  are registered trademarks of Semiconductor Components Industries, LLC (SCILLC). SCILLC owns the rights to a number of patents, trademarks, copyrights, trade secrets, and other intellectual property. A listing of SCILLC's product/patent coverage may be accessed at www.onsemi.com/site/pdf/Patent-Marking.pdf. SCILLC reserves the right to make changes without further notice to any products herein. SCILLC makes no warranty, representation or guarantee regarding the suitability of its products for any particular purpose, nor does SCILLC assume any liability arising out of the application or use of any product or circuit, and specifically disclaims any and all liability, including without limitation special, consequential or incidental damages. "Typical" parameters which may be provided in SCILLC data sheets and/or specifications can and do vary in different applications and actual performance may vary over time. All operating parameters, including "Typicals" must be validated for each customer application by customer's technical experts. SCILLC does not convey any license under its patent rights nor the rights of others. SCILLC products are not designed, intended, or authorized for use as components in systems intended for surgical implant into the body, or other applications intended to support or sustain life, or for any other application in which the failure of the SCILLC product could create a situation where personal injury or death may occur. Should Buyer purchase or use SCILLC products for any such unintended or unauthorized application, Buyer shall indemnify and hold SCILLC and its officers, employees, subsidiaries, affiliates, and distributors harmless against all claims, costs, damages, and expenses, and reasonable attorney fees arising out of, directly or indirectly, any claim of personal injury or death associated with such unintended or unauthorized use, even if such claim alleges that SCILLC was negligent regarding the design or manufacture of the part. SCILLC is an Equal Opportunity/Affirmative Action Employer. This literature is subject to all applicable copyright laws and is not for resale in any manner.

PUBLICATION ORDERING INFORMATION

LITERATURE FULFILLMENT:

Literature Distribution Center for ON Semiconductor
P.O. Box 5163, Denver, Colorado 80217 USA
Phone: 303-675-2175 or 800-344-3860 Toll Free USA/Canada
Fax: 303-675-2176 or 800-344-3867 Toll Free USA/Canada
Email: orderlit@onsemi.com

N. American Technical Support: 800-282-9855 Toll Free
USA/Canada

Europe, Middle East and Africa Technical Support:
Phone: 421 33 790 2910

Japan Customer Focus Center
Phone: 81-3-5817-1050

ON Semiconductor Website: www.onsemi.com

Order Literature: <http://www.onsemi.com/orderlit>

For additional information, please contact your local
Sales Representative