

Excellent Integrated System Limited

Stocking Distributor

Click to view price, real time Inventory, Delivery & Lifecycle Information:

[CNC Tech](#)
[750-10010-00200](#)

For any questions, you can email us directly:

sales@integrated-circuit.com

UNIT:mm

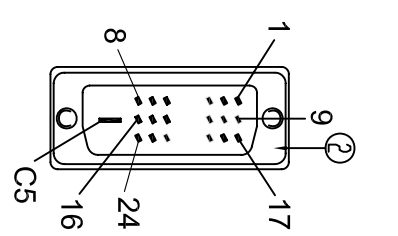
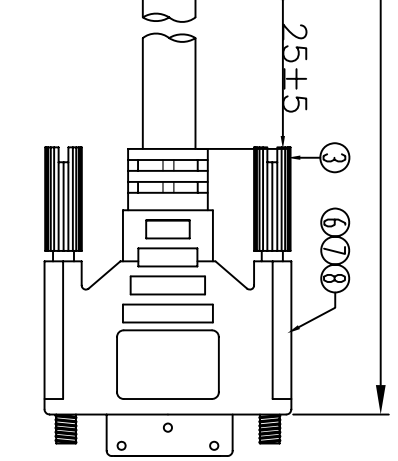
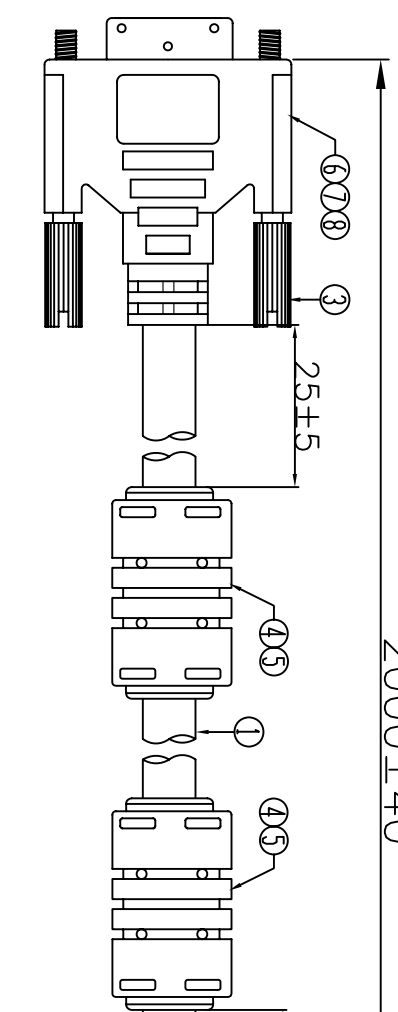
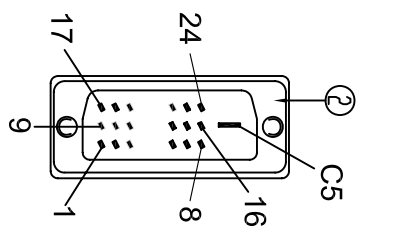

P1

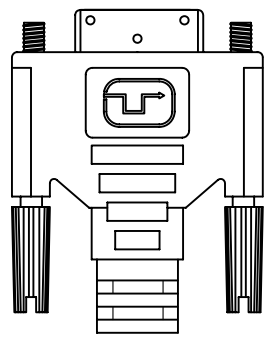

Electronic Test:

1. 100% Test,(Open,Short,Miss Wire)
2. Contact Resistance:2 ohm max.
3. Insulation Resistance:10M ohm min.
4. Hi-Pot:300V DC/10ms
5. BENDING TEST:ANGLE 90°,BENDING 2~3 TIMES UP AND DOWN.

P2

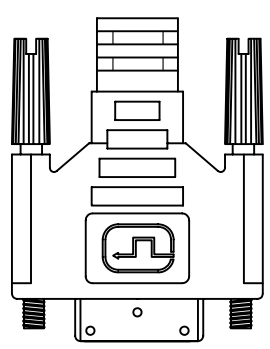

B

| | | | |
|---|------------|-----|--|
| ⑧ | TUBE | 8 | HEAT SHRINK TUBE BLACK OD2.0mm L=8mm |
| | | 8 | HEAT SHRINK TUBE BLACK OD1.0mm L=15mm |
| ⑦ | Copper | 2 | HEAT SHRINK TUBE BLACK OD0.8mm L=25mm |
| | | 2 | DOUBLE-SIDED CONDUCTIVE COPPER FOIL W30mm*L75mm |
| ⑥ | IN JACKET | 8g | CLEAR PE(NM-15) |
| | | 30g | WHITE(EC-005/W-18#) PVC 50P(WM-17) |
| ⑤ | OUT JACKET | 20g | BLACK PVC 45P (CH-002) |
| ④ | FERRITE | 2 | Core:RH17.5*10.6*28.5mm |
| ③ | SCREW | 4 | SCREW #4*40UNS Ø2.8*L32mm NICKEL MOLD WHITE(EC-005/W-18#) ABS |
| ② | CONN | 2 | DVI MALE 18+1 INSULATION BLACK,SHELL NICKEL,PIN GOLD FLASH. |
| ① | CABLE | 1 | UL20276 [(28AWG/1P+DW+AL/MY)*4C+28AWG*5C]+AL/MY+BD+D.W+BD+JACKET:BLACK OD:7.0±0.15mm L=2000+30/-0mm. |

| | | | |
|---|---------|-------------|--|
| CNC Tech, LLC Industrial Cable and Connector Technology | | | |
| DRAWN BY | ZHONGHS | DRAWING NO. | |
| CHECKED BY | | CUSTOMER | |
| APPROVAL BY | | ITEM NO. | 750-10010-00200 |
| DECIDE BY | | DATE | 2012-02-07 |
| VERSIONS/EDITEN | A/0 | PROJECTION |  |

A

NO. NAME Q'TY

SPECIFICATION

4 3 2 1

4 3 2 1