

Excellent Integrated System Limited

Stocking Distributor

Click to view price, real time Inventory, Delivery & Lifecycle Information:

[Molex Connector Corporation](#)
[0008500116](#)

For any questions, you can email us directly:

sales@integrated-circuit.com

J
I
H
G
F
E
D
C
B
A

J
I
H
G
F
E
D
C
B
A

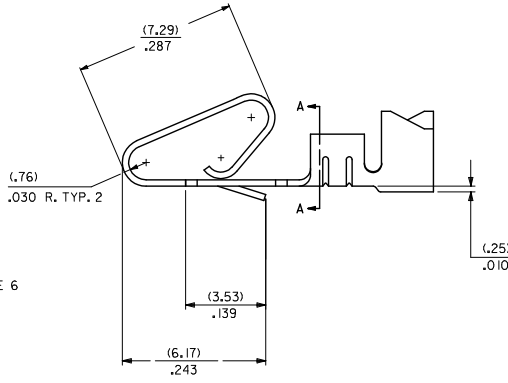
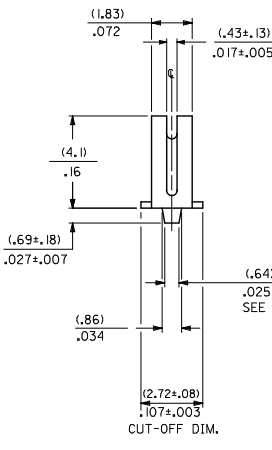
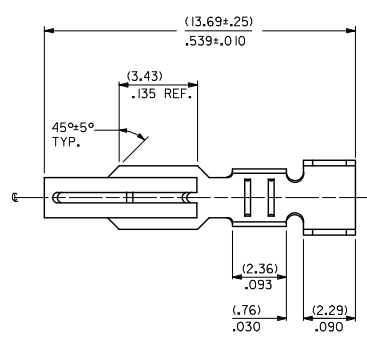
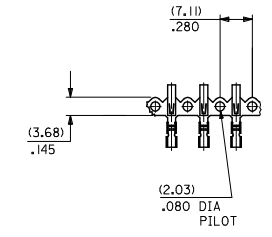

2878- * - * - * - *

MATERIAL CODE (.27)/.0106 THK

WINDING SPEC.
A=PER WINDING DETAIL A
B=PER WINDING DETAIL B
L=LOOSE

PLATING CODE
(P909) OVERALL HOT TIN DIP: (0.00254)/.000100 MIN.
(550) SELECT GOLD: (0.00038)/.000015 MIN.
OVERALL GOLD FLASH: (0.00005)/.000002 MIN.
OVERALL NICKEL UNDERPLATE: (0.00076)/.000030 MIN.
(555) SELECT GOLD: (0.00038)/.000015 MIN.
OVERALL NICKEL UNDERPLATE: (0.00076)/.000030 MIN.

OPTION CODE
A= OVERALL PLTGS, AND STD GOLD LOC
B= LARGER SELECT GOLD LOCATION

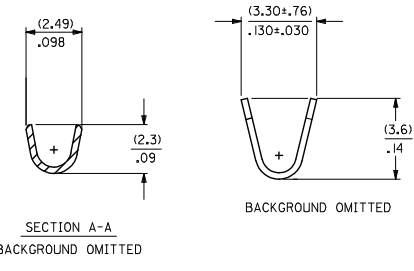

1. MATERIAL: SEE LEGEND
2. FINISH: SEE LEGEND
3. THIS PART CONFORMS TO PRODUCT SPECIFICATIONS PS-08-50, PS-172160-0001
4. PACKAGING SPECIFICATION: LOOSE FORM: PK-2759-001
CHAIN FORM: PK-2878-001
5. CRIMP ACCEPTS 18 TO 20 AWG WIRE WITH (2.79)/.110 MAX. INSULATION DIAMETER WHEN USED WITH 172159 SERIES HOUSINGS, (2.54)/.100 MAX INSULATION DIAMETER WHEN USED WITH 2139 OR 3069 SERIES HOUSINGS. CRIMP ACCEPTS (3.00)/.118 MAX. INSULATION DIAMETER WITH SPECIAL TOOLING.
6. (0.86±0.05)/.034±.002 IS AN OPTIONAL DESIGN.
7. PARTS CONFORM TO CLASS B REQUIREMENTS OF COSMETIC SPECIFICATION PS-45499-002.
8. MATING TERMINALS TO ROUND PINS IS NOT RECOMMENDED.

REVISE NOTES REC NO: UCP2015-3216 DRAWN/TIPER: 2015/02/06 CHKD/BELL: 2015/02/06 APPR/SMITH: 2015/02/18 AM1 REV	QUALITY SYMBOLS ∇=0 ∇=0 ∇=0	GENERAL TOLERANCES (UNLESS SPECIFIED)		DIMENSION STYLE MM/IN		SCALE 8:1	DESIGN UNITS INCH	THIRD ANGLE PROJECTION
		4 PLACES ± --- ± ---	DRAWN BY COMSTOCK	DATE 11/29/88	TITLE TERMINAL, DBL. CANTILEVER KK CRIMP TYPE BIFURCATED molex DOCUMENT NO. SD-2878 SHEET NO. 1 OF 2			
		3 PLACES ± --- ± .005	CHECKED BY PATEL	DATE 11/29/88				
		2 PLACES ± 0.13 ± .010	APPROVED BY SMITH	DATE 2015/02/18				
1 PLACE ± 0.25 ± --- 0 PLACE ± --- ± ---	MATERIAL NO. SEE CHART							
DRAFT WHERE APPLICABLE MUST REMAIN WITHIN DIMENSIONS		ANGULAR ± 1/2°		THIS DRAWING CONTAINS INFORMATION THAT IS PROPRIETARY TO MOLEX INCORPORATED AND SHOULD NOT BE USED WITHOUT WRITTEN PERMISSION				

2878-A-A(*)*			2878-B-A(*)*			2878-A-B(*)*		
PART NO.	ENG. NO.		PART NO.	ENG. NO.		PART NO.	ENG. NO.	
08-50-0115	2878-A-A(P909)B					08-55-0138	2878-A-B(555)B	
08-50-0116	2878-A-A(P909)L						2878-A-B(555)L	
			08-52-0126	* 2878-B-A(P909)B				
			08-52-0127	* 2878-B-A(P909)L				
			08-65-0118	* 2878-B-A(555)B				
			08-65-0119	* 2878-B-A(555)L				
			08-58-0127	* 2878-B-A(550)B				
			08-58-0128	* 2878-B-A(550)L				

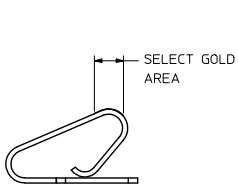

GOLD LOCATION OPTION A

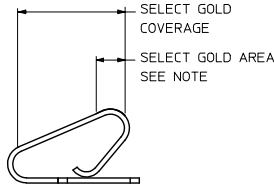

GOLD LOCATION OPTION B

NOTE: GOLD IS SPECIFIED THICKNESS IN SELECT GOLD AREA ONLY.

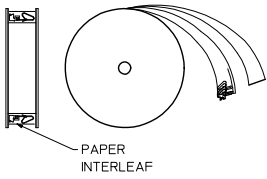

WINDING DETAIL A

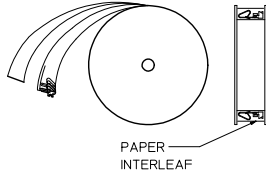

WINDING DETAIL B

SEE SHEET 1 EC NO: UCP2015-3216 DRAWN BY: DRINKUPPER 2015/02/06 CHKD: BELL 2015/02/06 APPROV: SMITH 2015/02/18 AM1 REV	QUALITY SYMBOLS ∇=0 ∇=0 ∇=0	GENERAL TOLERANCES (UNLESS SPECIFIED)		DIMENSION STYLE		SCALE	DESIGN UNITS	THIRD ANGLE PROJECTION	
			mm	INCH	MM/IN	8:1	INCH	☉	
		4 PLACES	±---	±---	DRAWN BY	DATE	TITLE		
		3 PLACES	±---	±.005	COMSTOCK	11/29/88	TERMINAL, DBL. CANTILEVER		
2 PLACES	±0.13	±.010	CHECKED BY	DATE	KK CRIMP TYPE				
1 PLACE	±0.25	±---	PATEL	11/29/88	BIFURCATED				
0 PLACE	±---	±---	APPROVED BY	DATE	molex				
			FSMITH	2015/02/18	MATERIAL NO.	DOCUMENT NO.	SHEET NO.		
					SEE CHART	SD-2878	2 OF 2		
DRAFT WHERE APPLICABLE MUST REMAIN WITHIN DIMENSIONS SIZE C THIS DRAWING CONTAINS INFORMATION THAT IS PROPRIETARY TO MOLEX INCORPORATED AND SHOULD NOT BE USED WITHOUT WRITTEN PERMISSION									