

Excellent Integrated System Limited

Stocking Distributor

Click to view price, real time Inventory, Delivery & Lifecycle Information:

[Molex Connector Corporation](#)
[0008700049](#)

For any questions, you can email us directly:

sales@integrated-circuit.com

ENG. NO. SD-5159*
EDP NO. 08-70-00**
DIMENSIONS IN METRIC DO NOT SCALE DRAWING

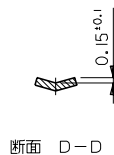
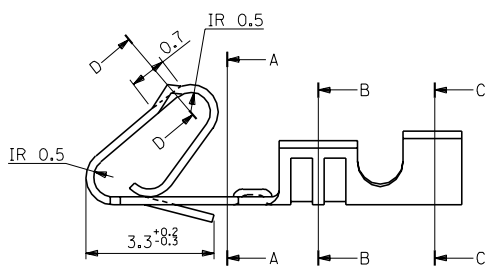
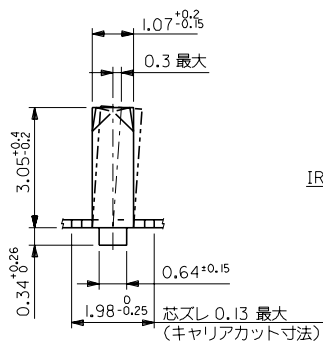
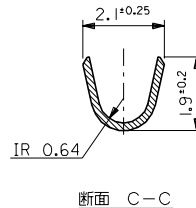
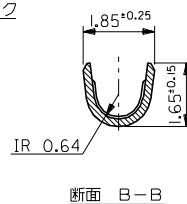
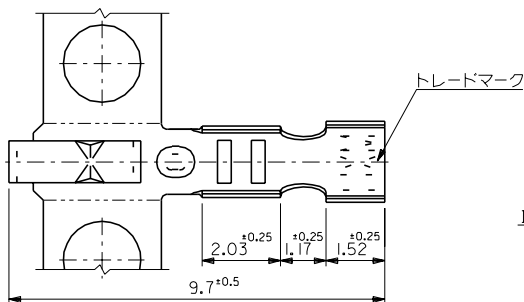
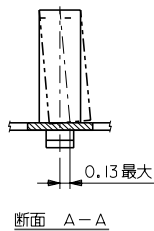

錫 0.9µm以上 リフロー処理	リン青銅 メッキ済	バラ状 連鎖状	08-70-0049 08-70-0048	5159PBT 5159PBT
錫 0.9µm以上 銅下地 0.5µm以上	黄銅 メッキ済	バラ状 連鎖状	08-70-0069 08-70-0064	5159TL 5159T
メッキ仕様	材質	端子形状	EDP NO.	ENG. NO.

材料 表参照 MATERIAL 表参照 板厚: 0.203	仕上げ 表参照 FINISH 表参照	適用電線範囲 WIRE RANGE AWG #22-#28	被覆外径 INS. RANGE Φ(1.2)-1.7	MOLEX-JAPAN CO.,LTD. 日本モレックス株式会社
角度 ANGLE ±3°	30以上 OVER ±0.3	10以上 30未満 UNDER ±0.25	10未満 UNDER ±0.2	EDP NO. 08-70-00**
一般公差	REVISION RECORD	DR. CHK. DATE	DRAWN BY 90/1/9 S.MOCHIZUKI CHK'D BY 91/02/26 M.FUKUSHIMA APP'D BY 91/03/26 尺度 SCALE 10-1	ENG. NO. SD-5159* REV J
REVISION RECORD				TITLE 名称 MINI. KK. CRIMP RECEPTACLE

THIS DRAWING CONTAINS INFORMATION THAT IS PROPRIETARY TO MOLEX(JAPAN) AND SHOULD NOT BE USED WITHOUT WRITTEN PERMISSION
本図面は日本モレックス(株)の所有する情報を含むもので 当社の許可なく複製を禁止する。 MXJ-8

ENG. NO. SD-5159*
EDP NO. 08-70-00**
DIMENSIONS IN METRIC DO NOT SCALE DRAWING

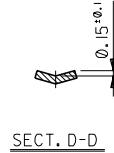
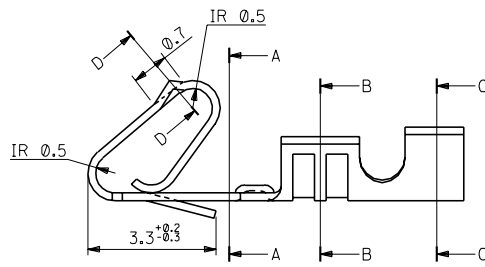
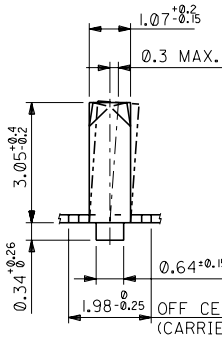
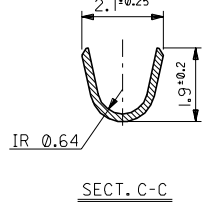
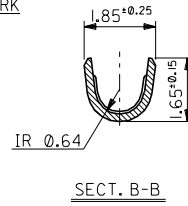
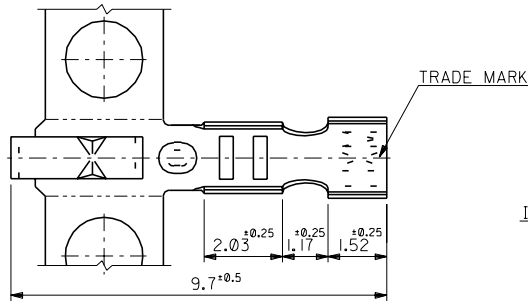
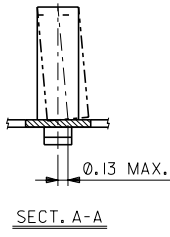

TIN 0.9µm MIN. REFLOW TREATMENT	PHOSPHOR BRONZE PRE PLATED	LOOSE	08-70-0049	5159PBT
TIN 0.9µm MIN. OVER COPPER 0.5µm MIN.	BRASS PRE PLATED	CHAIN	08-70-0048	5159PBT
PLATING	MATERIAL	LOOSE	08-70-0069	5159TL
		CHAIN	08-70-0064	5159T
		FORM	EDP NO.	ENG. NO.

角度 ANGLE	±3°				
30以上 OVER	±0.3				
10以上 30未満 UNDER	±0.25	J	REVISED & REDRAWN (100775)	S.M. 4/11	90/1/9
10未満 UNDER	±0.2	記号 TR	変更内容 REVISION RECORD	DR. CHK.	日付 DATE
一般公差					

材料 MATERIAL	SEE TABLE THK : 0.203	MOLEX-JAPAN CO.,LTD. 日本モレックス株式会社
仕上げ FINISH	SEE TABLE	
適用電線範囲 WIRE RANGE	AWG #22-#28	EDP NO. 08-70-00**
被覆外径 INS. RANGE	Φ (1.2)-1.7	ENG. NO. SD-5159*
DRAWN BY 90/1/9	CHK'D BY 90/02/26	TITLE 名称 MINI. KK. CRIMP RECEPTACLE
S.MOCHIZUKI	M.FUKUSHIMA	
APP'D BY 90/03/26	尺度 SCALE 10-1	
M.ENOMOTO		

THIS DRAWING CONTAINS INFORMATION THAT IS PROPRIETARY TO MOLEX(JAPAN) AND SHOULD NOT BE USED WITHOUT WRITTEN PERMISSION
本図面は日本モレックス(株)の所有する情報を含むもので 当社の許可なく複製を禁止する。 MXJ-8