

## Excellent Integrated System Limited

Stocking Distributor

Click to view price, real time Inventory, Delivery & Lifecycle Information:

[Kingbright](#)  
[SC10-21YWA](#)

For any questions, you can email us directly:

[sales@integrated-circuit.com](mailto:sales@integrated-circuit.com)

# Kingbright

## 25.4mm (1.0 INCH) SINGLE DIGIT NUMERIC DISPLAY

Part Number: SC10-21YWA

Yellow

### Features

- 1.0 inch digit height.
- Low current operation.
- Excellent character appearance.
- High light output.
- Easy mounting on P.C. boards or sockets.
- Mechanically rugged.
- Standard : gray face, white segment.
- RoHS compliant.

### Description

The Yellow source color devices are made with Gallium Arsenide Phosphide on Gallium Phosphide Yellow Light Emitting Diode.

### Package Dimensions & Internal Circuit Diagram

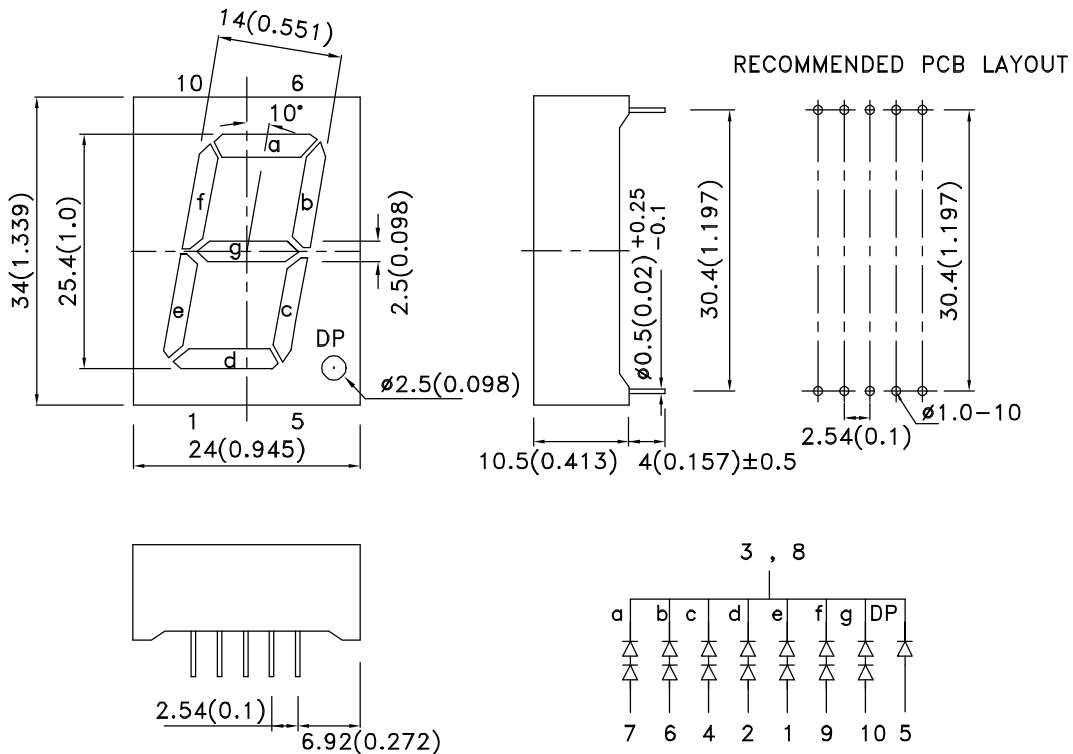

**Notes:**

1. All dimensions are in millimeters (inches), Tolerance is ± 0.25(0.01")unless otherwise noted.
2. The specifications, characteristics and technical data described in the datasheet are subject to change without prior notice.



# Kingbright

## Selection Guide

| Part No.   | Dice               | Lens Type      | Iv (ucd) [1]<br>@ 10mA |       | Description                         |
|------------|--------------------|----------------|------------------------|-------|-------------------------------------|
|            |                    |                | Min.                   | Typ.  |                                     |
| SC10-21YWA | Yellow (GaAsP/GaP) | White Diffused | 9000                   | 23000 | Common Cathode,<br>Rt. Hand Decimal |
|            |                    |                | *3600                  | *7000 |                                     |

Notes:

- Luminous intensity/ luminous Flux: +/-15%.
- \*Luminous intensity value is traceable to the CIE127-2007 compliant national standards.

## Electrical / Optical Characteristics at TA=25°C

| Symbol                | Parameter                  | Device | Typ.         | Max.         | Units | Test Conditions                            |
|-----------------------|----------------------------|--------|--------------|--------------|-------|--|
| $\lambda_{peak}$      | Peak Wavelength            | Yellow | 590          |              | nm    | I <sub>F</sub> =20mA                       |
| $\lambda_D$ [1]       | Dominant Wavelength        | Yellow | 588          |              | nm    | I <sub>F</sub> =20mA                       |
| $\Delta\lambda_{1/2}$ | Spectral Line Half-width   | Yellow | 35           |              | nm    | I <sub>F</sub> =20mA                       |
| C                     | Capacitance                | Yellow | 20           |              | pF    | V <sub>F</sub> =0V;f=1MHz                  |
| V <sub>F</sub> [2]    | Forward Voltage (DP)       | Yellow | 4.2<br>(2.1) | 5.0<br>(2.5) | V     | I <sub>F</sub> =20mA                       |
| I <sub>R</sub>        | Reverse Current (Per chip) | Yellow |              | 10<br>(10)   | uA    | V <sub>R</sub> =5V<br>(V <sub>R</sub> =5V) |

Notes:

- Wavelength: +/-1nm.
- Forward Voltage: +/-0.1V.
- Wavelength value is traceable to the CIE127-2007 compliant national standards.

## Absolute Maximum Ratings at TA=25°C

| Parameter                       | Yellow                | Units |
|---------------------------------|-----------------------|-------|
| Power dissipation (DP)          | 150<br>(75)           | mW    |
| DC Forward Current              | 30<br>(30)            | mA    |
| Peak Forward Current [1]        | 140<br>(140)          | mA    |
| Reverse Voltage (Per chip)      | 5<br>(5)              | V     |
| Operating / Storage Temperature | -40°C To +85°C        |       |
| Lead Solder Temperature[2]      | 260°C For 3-5 Seconds |       |

Notes:

- 1/10 Duty Cycle, 0.1ms Pulse Width.
- 2mm below package base.

# Kingbright



**Yellow**

**SC10-21YWA**

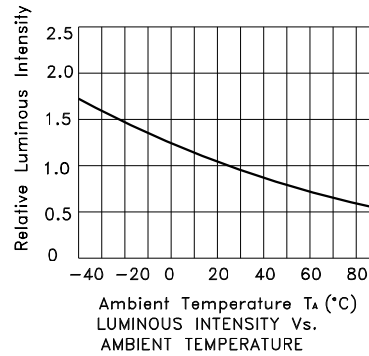
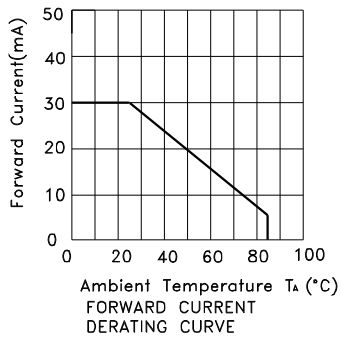
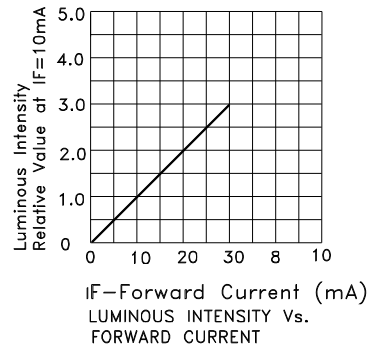
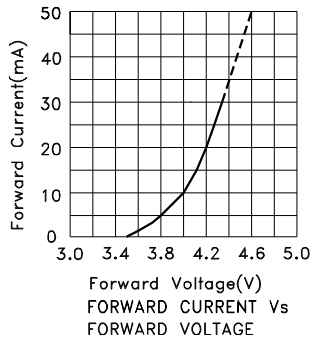

# Kingbright

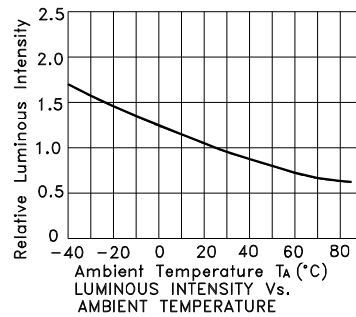
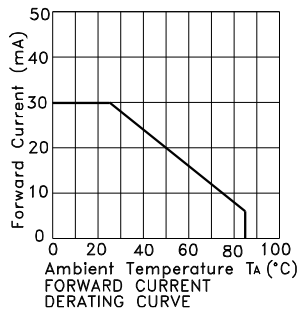
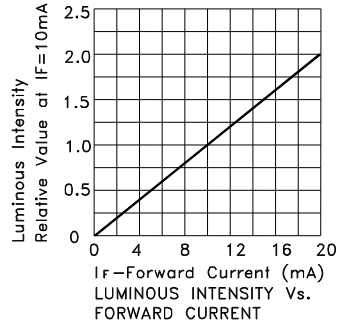
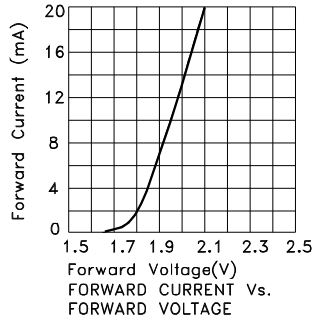

# Kingbright

## PACKING & LABEL SPECIFICATIONS

## SC10-21YWA

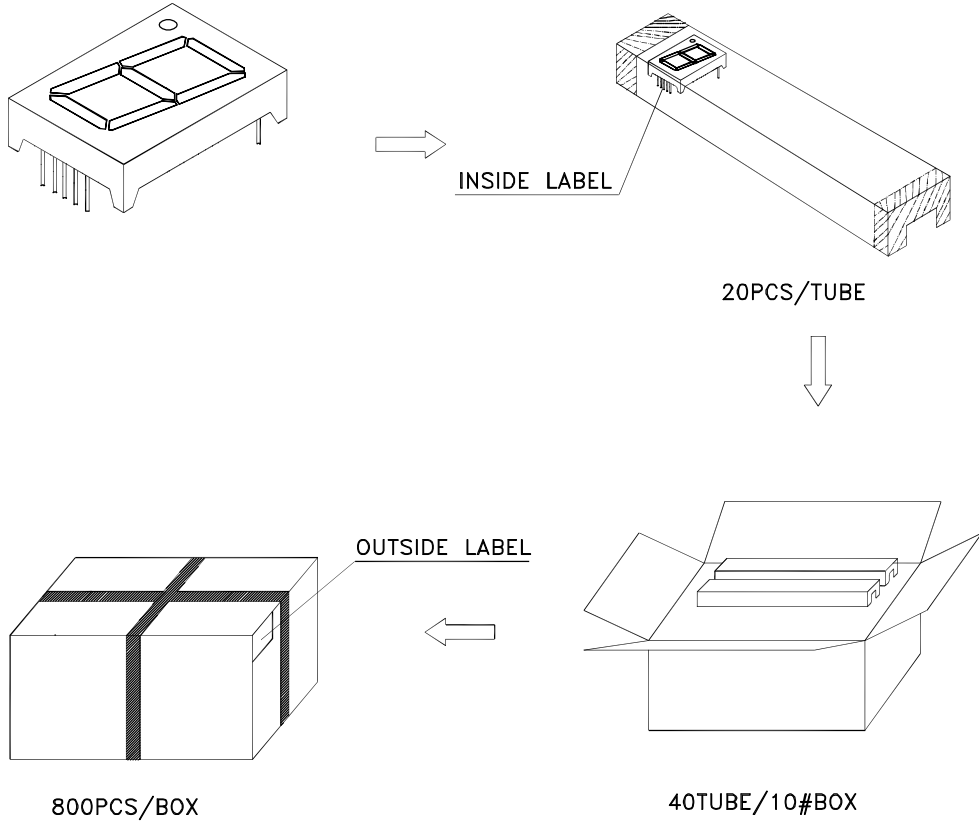

### Inside Label On IC-tube

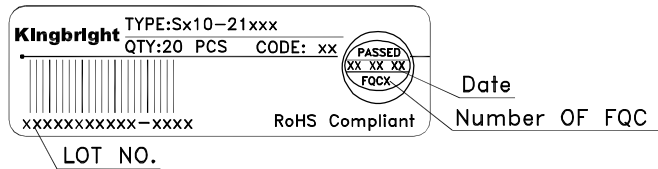

### Outside Label On Box

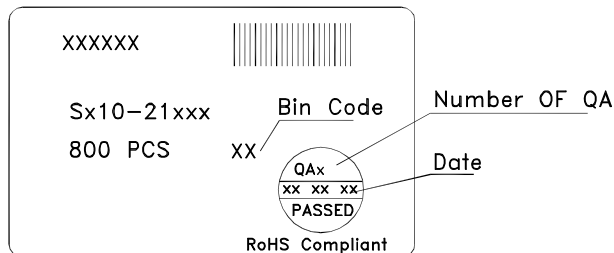

# Kingbright

## THROUGH HOLE DISPLAY MOUNTING METHOD

### Lead Forming

Do not bend the component leads by hand without proper tools.  
 The leads should be bent by clinching the upper part of the lead firmly such that the bending force is not exerted on the plastic body.

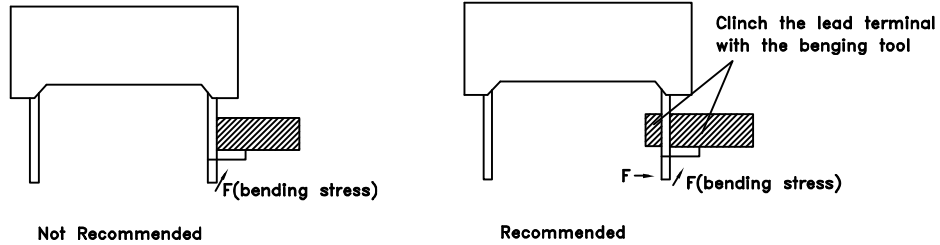

### Installation

- 1.The installation process should not apply stress to the lead terminals.
- 2.When inserting for assembly, ensure the terminal pitch matches the substrate board's hole pitch to prevent spreading or pinching the lead terminals.

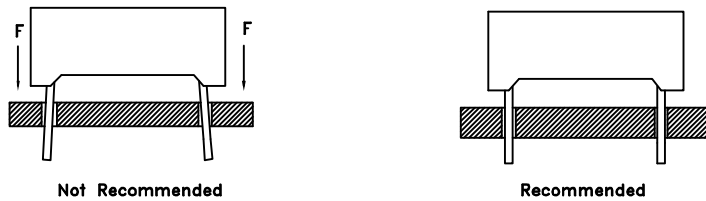

- 3.The component shall be placed at least 5mm from edge of PCB to avoid damage caused excessive heat during wave soldering.

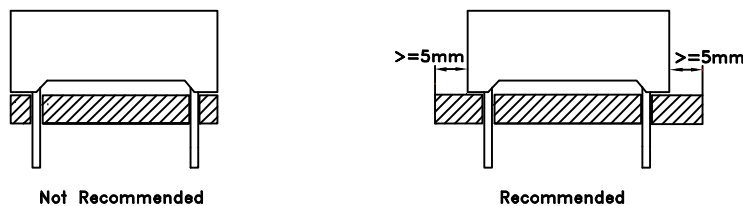

# Kingbright

## DISPLAY SOLDERING CONDITIONS

Wave Soldering Profile For Lead-free Through-hole LED.

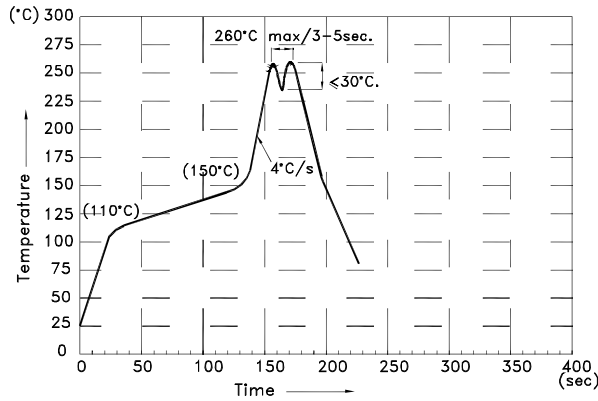

**NOTES:**

1. Recommend the wave temperature 245°C~260°C. The maximum soldering temperature should be less than 260°C.
2. Do not apply stress on epoxy resins when temperature is over 85°C.
3. The soldering profile apply to the lead free soldering (Sn/Cu/Ag alloy).
4. During wave soldering, the PCB top-surface temperature should be kept below 105°C
5. No more than once.

### Soldering General Notes:

1. Through-hole displays are incompatible with reflow soldering.
2. If components will undergo multiple soldering processes, or other processes where the components may be subjected to intense heat, please check with Kingbright for compatibility.

### CLEANING

1. Mild "no-clean" fluxes are recommended for use in soldering.
2. If cleaning is required, Kingbright recommends to wash components with water only. Do not use harsh organic solvents for cleaning, because they may damage the plastic parts. And the devices should not be washed for more than one minute.

### CIRCUIT DESIGN NOTES

1. Protective current-limiting resistors may be necessary to operate the Displays.
2. LEDs mounted in parallel should each be placed in series with its own current-limiting resistor.

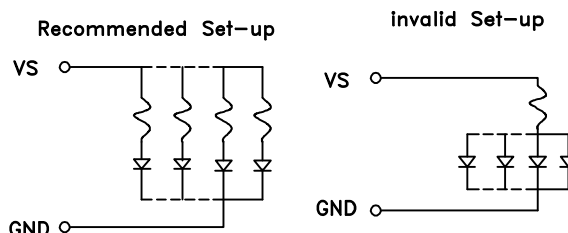

All design applications should refer to Kingbright application notes available at <http://www.KingbrightUSA.com/ApplicationNotes>