

## Excellent Integrated System Limited

Stocking Distributor

Click to view price, real time Inventory, Delivery & Lifecycle Information:

[Alpha & Omega Semiconductor Inc.](#)  
[AOT474](#)

For any questions, you can email us directly:

[sales@integrated-circuit.com](mailto:sales@integrated-circuit.com)



## AOT474/AOTF474

### 75V N-Channel MOSFET

#### General Description

The AOT474 and AOTF474 use a robust technology that is designed to provide efficient and reliable power conversion even in the most demanding applications, including motor control. With low  $R_{DS(ON)}$  and excellent thermal capability this device is appropriate for high current switching and can endure adverse operating conditions.

#### Product Summary

$V_{DS}$	75V
$I_D$ (TO220 at $V_{GS}=10V$ )	127A
$I_D$ (TO220FL at $V_{GS}=10V$ )	47A
$R_{DS(ON)}$ (at $V_{GS}=10V$ )	< 11.3m $\Omega$

100% UIS Tested  
100% Rg Tested

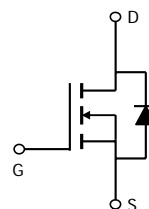
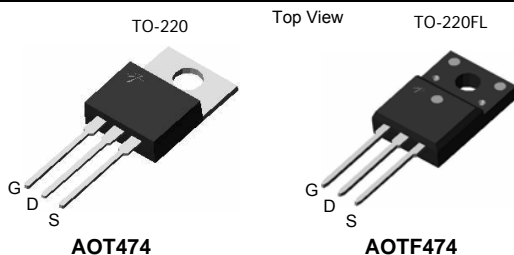

#### Absolute Maximum Ratings $T_A=25^\circ C$ unless otherwise noted

Parameter	Symbol	AOT474	AOTF474	Units	
Drain-Source Voltage	$V_{DS}$	75		V	
Gate-Source Voltage	$V_{GS}$	$\pm 20$		V	
Continuous Drain Current	$I_D$	$T_C=25^\circ C$	127	47	A
		$T_C=100^\circ C$	89	33	
Pulsed Drain Current <sup>C</sup>	$I_{DM}$	240			
Continuous Drain Current	$I_{DSM}$	$T_A=25^\circ C$	9	9	A
		$T_A=70^\circ C$	7	7	
Avalanche Current <sup>C</sup>	$I_{AS}, I_{AR}$	106		A	
Avalanche energy $L=0.1mH$ <sup>C</sup>	$E_{AS}, E_{AR}$	562		mJ	
Power Dissipation <sup>B</sup>	$P_D$	$T_C=25^\circ C$	417	57.5	W
		$T_C=100^\circ C$	208	29	
Power Dissipation <sup>A</sup>	$P_{DSM}$	$T_A=25^\circ C$	1.9	1.9	W
		$T_A=70^\circ C$	1.2	1.2	
Junction and Storage Temperature Range	$T_J, T_{STG}$	-55 to 175		$^\circ C$	

#### Thermal Characteristics

Parameter	Symbol	AOT474	AOTF474	Units
Maximum Junction-to-Ambient <sup>A</sup>	$R_{\theta JA}$	13.9	13.9	$^\circ C/W$
Maximum Junction-to-Ambient <sup>AD</sup>		Steady-State	65	65
Maximum Junction-to-Case	$R_{\theta JC}$	0.36	2.6	$^\circ C/W$

**Electrical Characteristics (T<sub>J</sub>=25°C unless otherwise noted)**

Symbol	Parameter	Conditions	Min	Typ	Max	Units
<b>STATIC PARAMETERS</b>						
BV <sub>DSS</sub>	Drain-Source Breakdown Voltage	I <sub>D</sub> =250μA, V <sub>GS</sub> =0V	75			V
I <sub>DSS</sub>	Zero Gate Voltage Drain Current	V <sub>DS</sub> =75V, V <sub>GS</sub> =0V T <sub>J</sub> =55°C			1 5	μA
I <sub>GSS</sub>	Gate-Body leakage current	V <sub>DS</sub> =0V, V <sub>GS</sub> = ±20V			100	nA
V <sub>GS(th)</sub>	Gate Threshold Voltage	V <sub>DS</sub> =V <sub>GS</sub> , I <sub>D</sub> =250μA	2.6	3.4	4	V
I <sub>D(ON)</sub>	On state drain current	V <sub>GS</sub> =10V, V <sub>DS</sub> =5V	240			A
R <sub>DS(ON)</sub>	Static Drain-Source On-Resistance	V <sub>GS</sub> =10V, I <sub>D</sub> =30A T <sub>J</sub> =125°C		9.4 18	11.3 21.5	mΩ
g <sub>FS</sub>	Forward Transconductance	V <sub>DS</sub> =5V, I <sub>D</sub> =30A		67		S
V <sub>SD</sub>	Diode Forward Voltage	I <sub>S</sub> =1A, V <sub>GS</sub> =0V		0.73	1	V
I <sub>S</sub>	Maximum Body-Diode Continuous Current				128	A
<b>DYNAMIC PARAMETERS</b>						
C <sub>iss</sub>	Input Capacitance	V <sub>GS</sub> =0V, V <sub>DS</sub> =30V, f=1MHz	2240	2805	3370	pF
C <sub>oss</sub>	Output Capacitance		355	507	660	pF
C <sub>rss</sub>	Reverse Transfer Capacitance		22	36	50	pF
R <sub>g</sub>	Gate resistance	V <sub>GS</sub> =0V, V <sub>DS</sub> =0V, f=1MHz	1.4	2.8	4.2	Ω
<b>SWITCHING PARAMETERS</b>						
Q <sub>g(10V)</sub>	Total Gate Charge	V <sub>GS</sub> =10V, V <sub>DS</sub> =30V, I <sub>D</sub> =30A	39	49.6	60	nC
Q <sub>gs</sub>	Gate Source Charge		11	13.8	17	nC
Q <sub>gd</sub>	Gate Drain Charge		8	14	20	nC
t <sub>D(on)</sub>	Turn-On DelayTime	V <sub>GS</sub> =10V, V <sub>DS</sub> =30V, R <sub>L</sub> =1Ω, R <sub>GEN</sub> =3Ω		15		ns
t <sub>r</sub>	Turn-On Rise Time			34		ns
t <sub>D(off)</sub>	Turn-Off DelayTime			42		ns
t <sub>f</sub>	Turn-Off Fall Time			4.5		ns
t <sub>rr</sub>	Body Diode Reverse Recovery Time	I <sub>F</sub> =30A, dI/dt=500A/μs	35	50	65	ns
Q <sub>rr</sub>	Body Diode Reverse Recovery Charge	I <sub>F</sub> =30A, dI/dt=500A/μs	330	472	614	nC

A. The value of R<sub>θJA</sub> is measured with the device mounted on 1in<sup>2</sup> FR-4 board with 2oz. Copper, in a still air environment with T<sub>A</sub>=25°C. The Power dissipation P<sub>DSM</sub> is based on R<sub>θJA</sub> and the maximum allowed junction temperature of 150°C. The value in any given application depends on the user's specific board design, and the maximum temperature of 175°C may be used if the PCB allows it.

B. The power dissipation P<sub>D</sub> is based on T<sub>J(MAX)</sub>=175°C, using junction-to-case thermal resistance, and is more useful in setting the upper dissipation limit for cases where additional heatsinking is used.

C. Repetitive rating, pulse width limited by junction temperature T<sub>J(MAX)</sub>=175°C. Ratings are based on low frequency and duty cycles to keep initial T<sub>J</sub>=25°C.

D. The R<sub>θJA</sub> is the sum of the thermal impedance from junction to case R<sub>θJC</sub> and case to ambient.

E. The static characteristics in Figures 1 to 6 are obtained using <300μs pulses, duty cycle 0.5% max.

F. These curves are based on the junction-to-case thermal impedance which is measured with the device mounted to a large heatsink, assuming a maximum junction temperature of T<sub>J(MAX)</sub>=175°C. The SOA curve provides a single pulse rating.

G. These tests are performed with the device mounted on 1 in<sup>2</sup> FR-4 board with 2oz. Copper, in a still air environment with T<sub>A</sub>=25°C.

Rev 0:February 2009

COMPONENTS IN LIFE SUPPORT DEVICES OR SYSTEMS ARE NOT AUTHORIZED. AOS DOES NOT ASSUME ANY LIABILITY ARISING OUT OF SUCH APPLICATIONS OR USES OF ITS PRODUCTS. AOS RESERVES THE RIGHT TO IMPROVE PRODUCT DESIGN, FUNCTIONS AND RELIABILITY WITHOUT NOTICE.

**TYPICAL ELECTRICAL AND THERMAL CHARACTERISTICS**

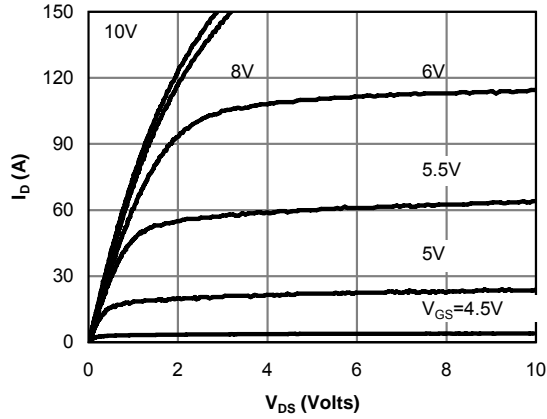

Figure 1: On-Region Characteristics (Note E)

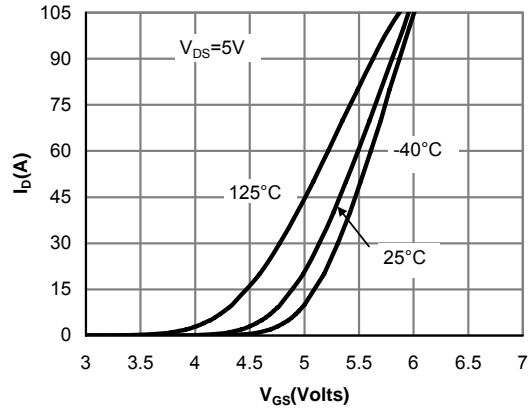

Figure 2: Transfer Characteristics (Note E)

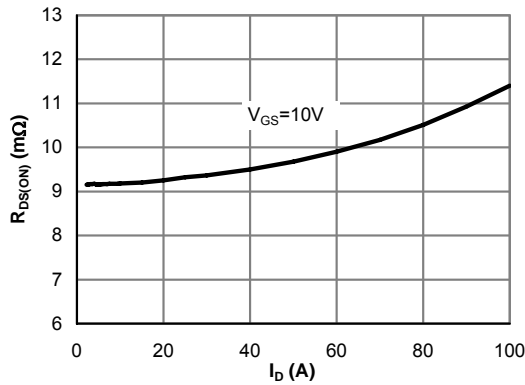

Figure 3: On-Resistance vs. Drain Current and Gate Voltage (Note E)

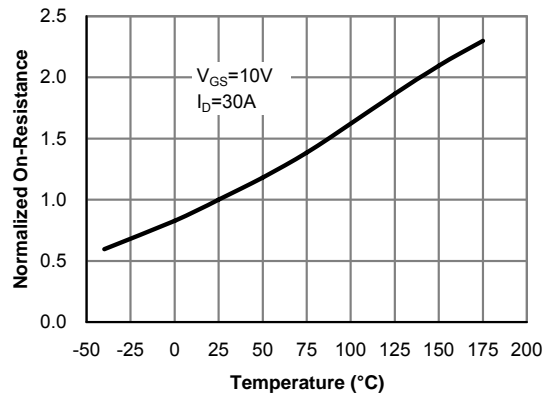

Figure 4: On-Resistance vs. Junction Temperature (Note E)

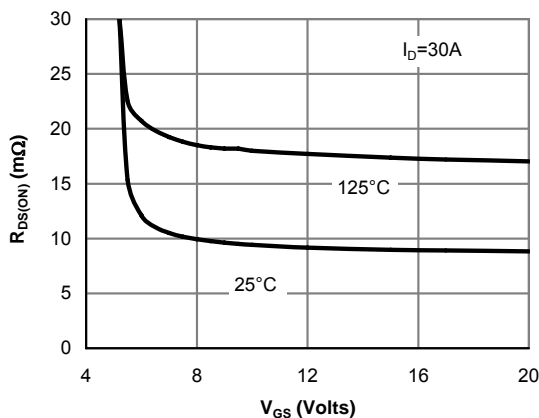

Figure 5: On-Resistance vs. Gate-Source Voltage (Note E)

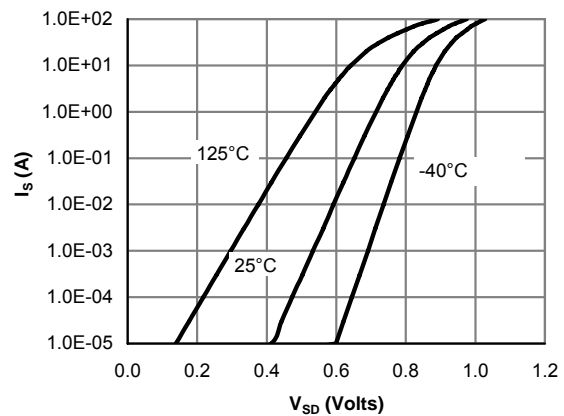

Figure 6: Body-Diode Characteristics (Note E)

**TYPICAL ELECTRICAL AND THERMAL CHARACTERISTICS**

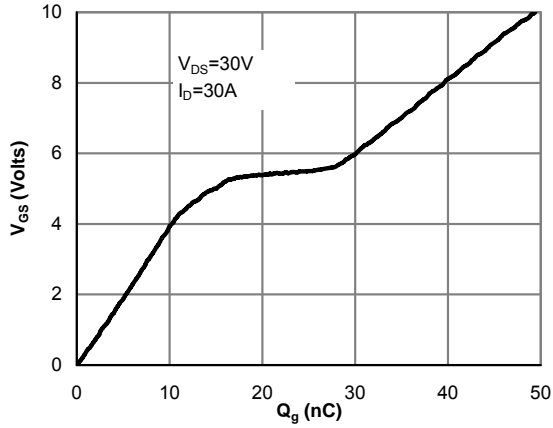

Figure 7: Gate-Charge Characteristics

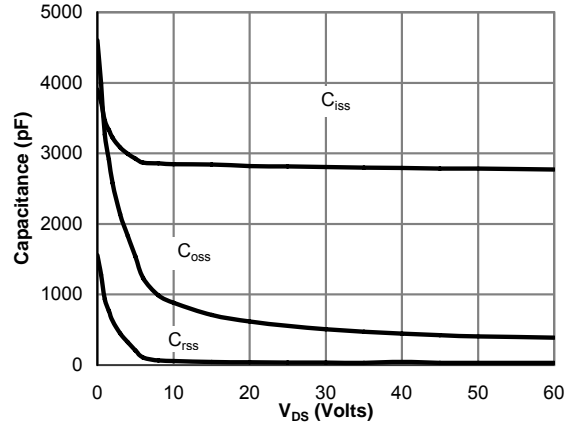

Figure 8: Capacitance Characteristics

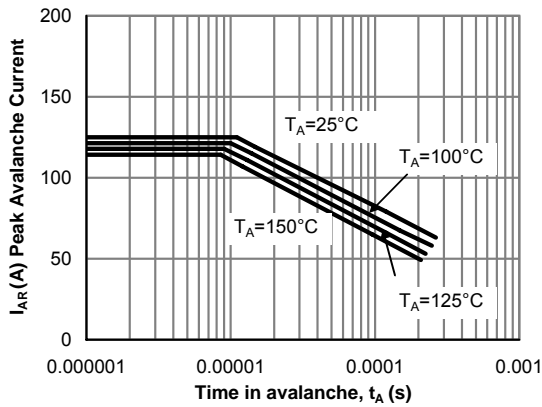

Figure 9: Single Pulse Avalanche capability (Note C)

**TYPICAL ELECTRICAL AND THERMAL CHARACTERISTICS**

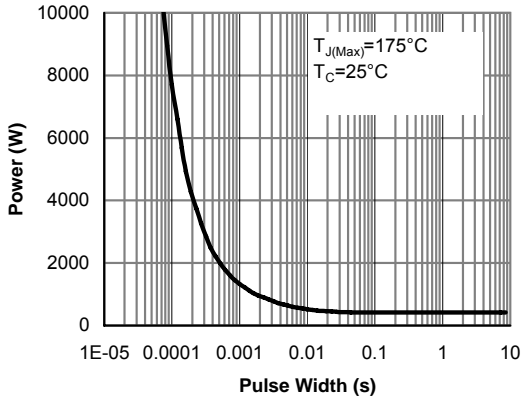

Figure 10: Single Pulse Power Rating Junction-to-Case for AOT474 (Note F)

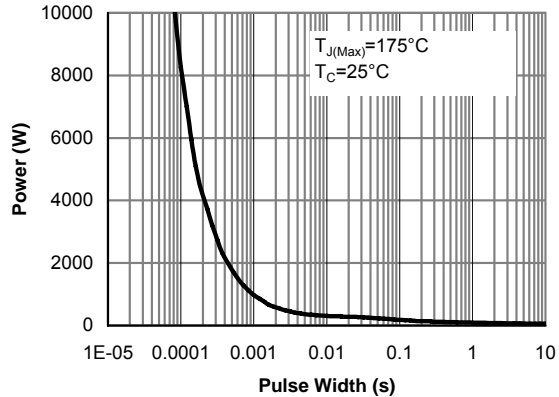

Figure 11: Single Pulse Power Rating Junction-to-Case for AOTF474 (Note F)

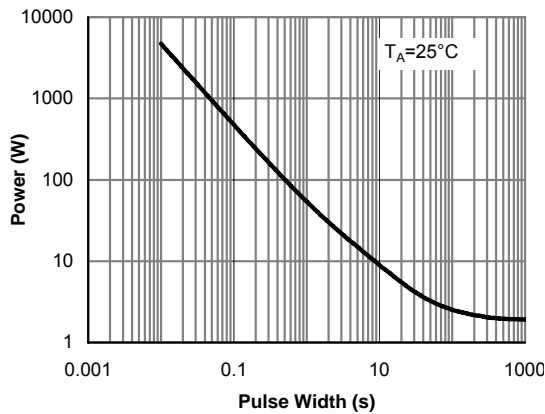

Figure 12: Single Pulse Power Rating Junction-to-Ambient for AOT474 (Note G)

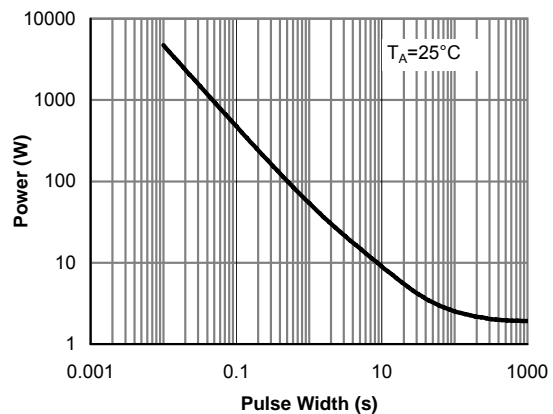

Figure 13: Single Pulse Power Rating Junction-to-Ambient for AOTF474 (Note G)

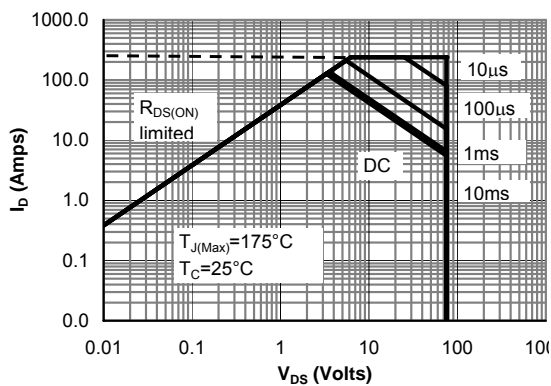

Figure 14: Maximum Forward Biased Safe Operating Area for AOT474 (Note F)

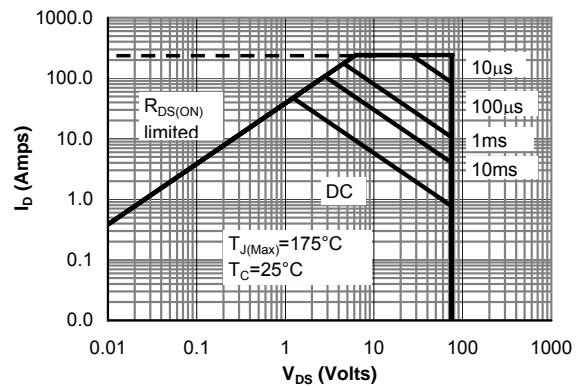

Figure 15: Maximum Forward Biased Safe Operating Area for AOTF474 (Note F)

**TYPICAL ELECTRICAL AND THERMAL CHARACTERISTICS**

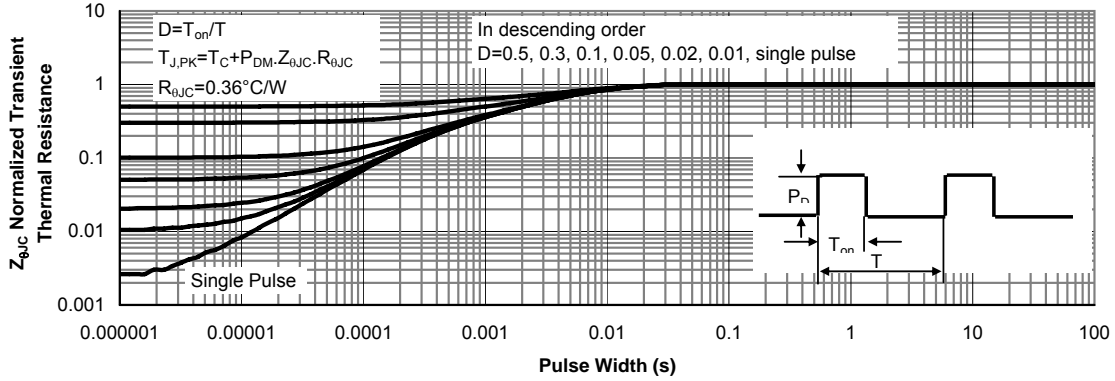

Figure 16: Normalized Maximum Transient Thermal Impedance for AOT474 (Note F)

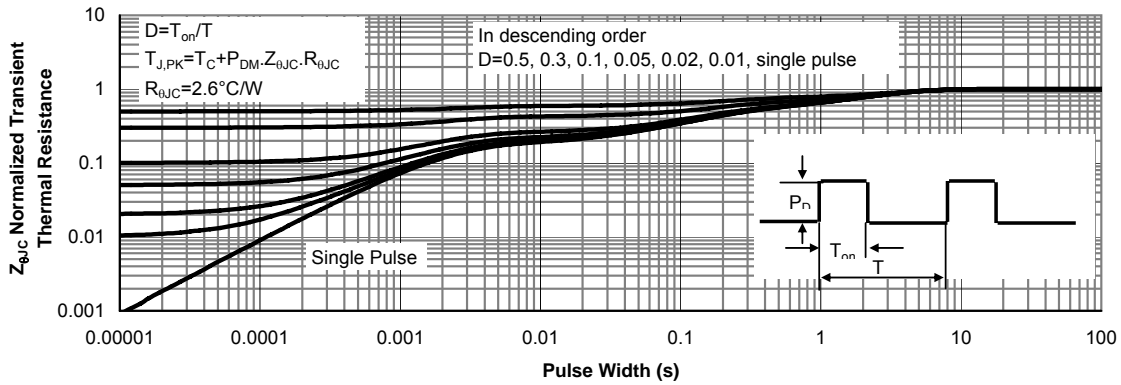
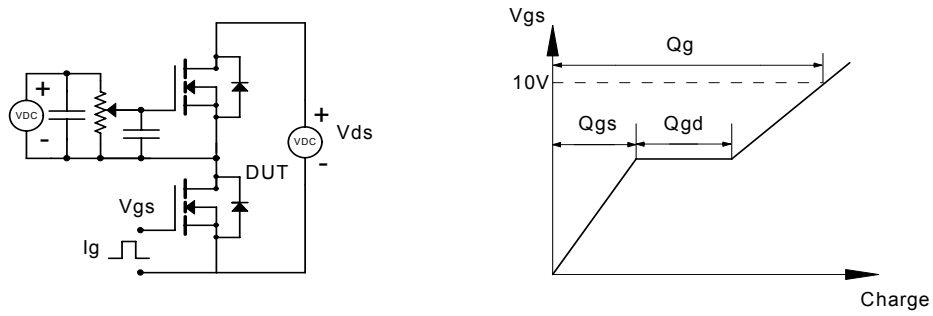
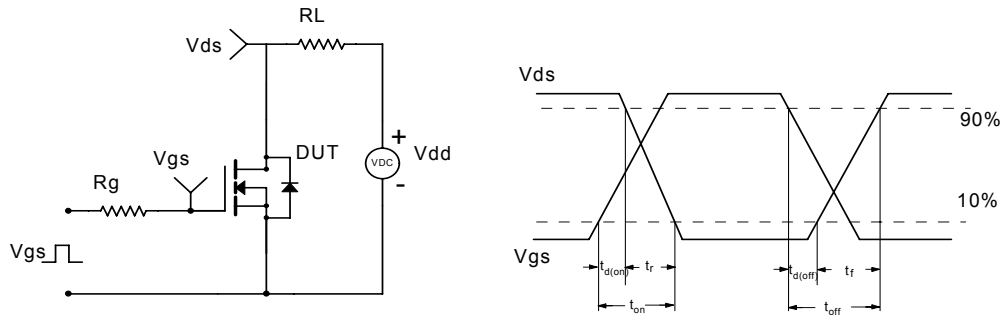

Figure 17: Normalized Maximum Transient Thermal Impedance for AOTF474 (Note F)

Gate Charge Test Circuit & Waveform



Resistive Switching Test Circuit & Waveforms



Unclamped Inductive Switching (UIS) Test Circuit & Waveforms

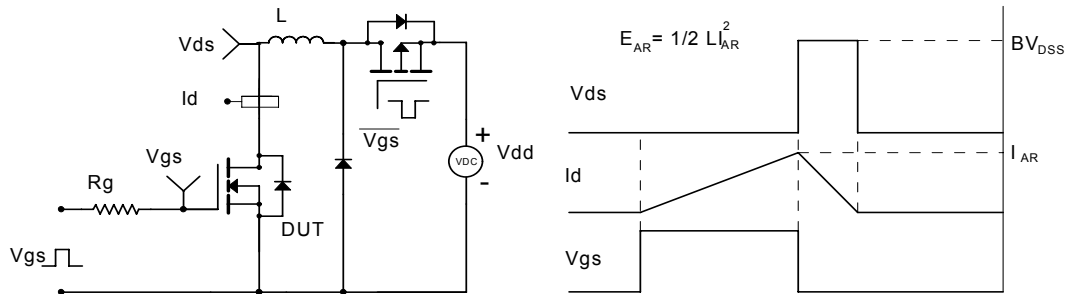

Diode Recovery Test Circuit & Waveforms

