

Excellent Integrated System Limited

Stocking Distributor

Click to view price, real time Inventory, Delivery & Lifecycle Information:

[Molex Connector Corporation](#)
[0194280023](#)

For any questions, you can email us directly:
sales@integrated-circuit.com

ASSEMBLY MATERIAL NUMBER	TERMINAL PLATING
194280001	TIN
194280023	TIN/GOLD

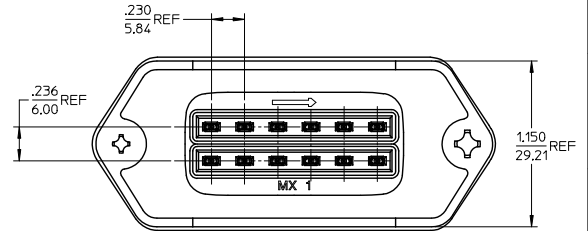
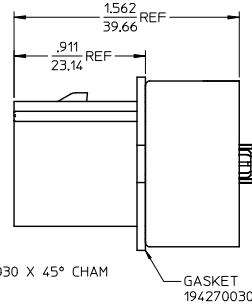
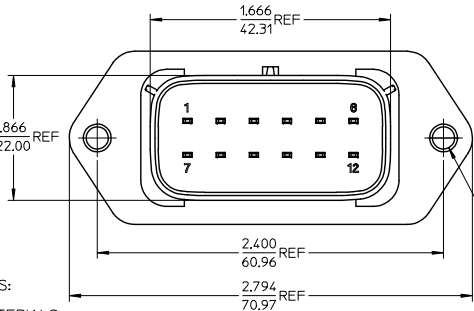
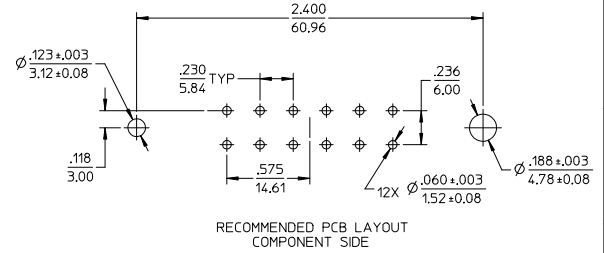
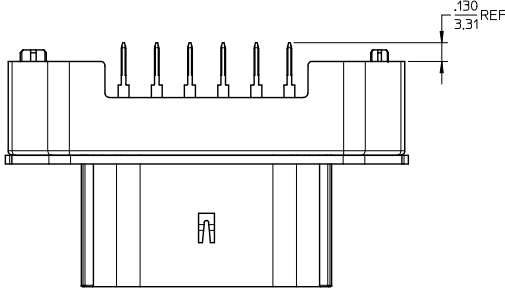
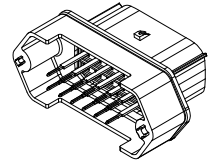
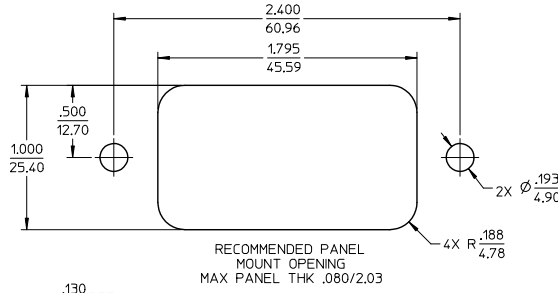

NOTES:

- MATERIALS:
HOUSING: POLYESTER (PBT), GLASS FILLED, UL94 V-0,
COLOR: BLACK
TERMINALS: COPPER ALLOY
- FINISHES: 1. TIN ONLY: 100µN TIN OVER 50µN NICKEL
2. TIN/GOLD: 30µN SELECT GOLD (CONTACT MATING AREA),
100µN SELECT TIN (PCB TAIL AREA) OVER 50µN NICKEL OVERALL.
- PRODUCT SPECIFICATION: PS-19428-001.
- PACKAGING SPECIFICATION: PK-19428-001.
- MATES WITH: 19418 SERIES RECEPTACLE ASSEMBLIES.
- RECOMMENDED MOUNTING HARDWARE: (2) #10 X .62/18.9 LONG PLASTIC
THREAD CUTTING SCREWS, RECOMMENDED TORQUE 15-17 IN.-LBS.
SUGGESTED SOURCE: ITW SHAKEPROOF INDUSTRIAL BOSSCREW OR EQUIVALENT.

REVISED EC NO: ETC2006-0028 DRAWN: JPAWLICK 2005/10/10 CHKD: JPAWLICK 2005/10/11 APPR: RDEROSS 2005/10/11 DESCRIPTION	QUALITY SYMBOLS	GENERAL TOLERANCES (UNLESS SPECIFIED)	DIMENSION STYLE	SCALE	DESIGN UNITS	THIRD ANGLE PROJECTION															
	$\nabla=0$ $\sphericalangle=0$	<table border="1"> <tr> <th></th> <th>mm</th> <th>INCH</th> </tr> <tr> <td>4 PLACES</td> <td>± .15</td> <td>± .005</td> </tr> <tr> <td>3 PLACES</td> <td>± .10</td> <td>± .004</td> </tr> <tr> <td>2 PLACES</td> <td>± .08</td> <td>± .003</td> </tr> <tr> <td>1 PLACE</td> <td>± .05</td> <td>± .002</td> </tr> </table>		mm	INCH	4 PLACES	± .15	± .005	3 PLACES	± .10	± .004	2 PLACES	± .08	± .003	1 PLACE	± .05	± .002	IN/MM	2:1	INCH	
		mm	INCH																		
	4 PLACES	± .15	± .005																		
3 PLACES	± .10	± .004																			
2 PLACES	± .08	± .003																			
1 PLACE	± .05	± .002																			
DRAFT WHERE APPLICABLE MUST REMAIN WITHIN DIMENSIONS	DRAWN BY: DMYRICK CHECKED BY: JPAWLICK APPROVED BY: RDEROSS DATE: 04/07/07 DATE: 04/07/07 DATE: 04/07/07	MATERIAL NO. SEE CHART	TITLE 12-WAY STRAIGHT HEADER ASSEMBLY, LONG VERSION	MOLEX INCORPORATED	SHEET NO. 1 OF 1																
THIS DRAWING CONTAINS INFORMATION THAT IS PROPRIETARY TO MOLEX INCORPORATED AND SHOULD NOT BE USED WITHOUT WRITTEN PERMISSION																					