

Excellent Integrated System Limited

Stocking Distributor

Click to view price, real time Inventory, Delivery & Lifecycle Information:

[Molex Connector Corporation](#)
[0307005169](#)

For any questions, you can email us directly:

sales@integrated-circuit.com

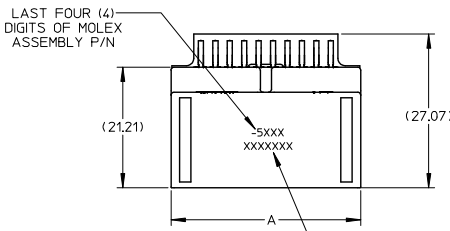

20 CIRCUIT RIGHT ANGLE HEADER ASSEMBLY SHOWN

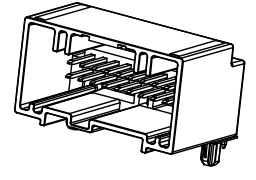
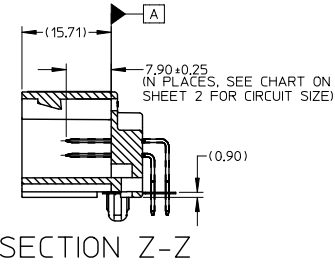

DATECODE, SEE NOTE 6

SECTION Z-Z

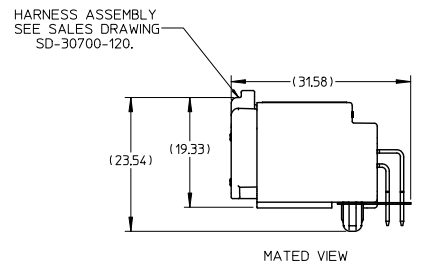
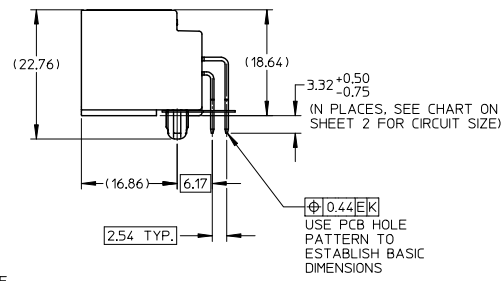
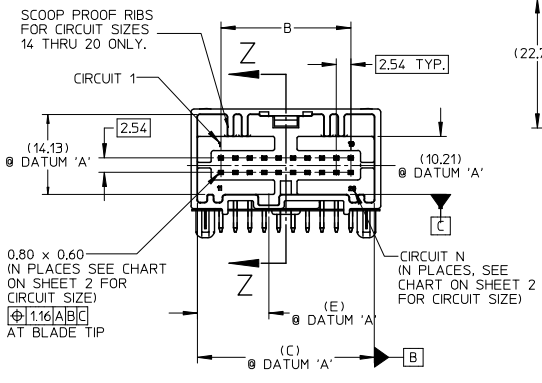

HARNESS ASSEMBLY
SEE SALES DRAWING
SD-30700-120.

MATED VIEW

NOTES:

- MATERIAL: HOUSING: SPS, GLASS FILLED, COLOR: SEE CHART. TERMINAL: COPPER ALLOY. PIN ALIGNMENT PLATE: NYLON, COLOR: NATURAL (WHITE).
- FINISHES: TERMINAL: 1.50-2.50µm TIN (Sn) OVERALL; 1.25µm MIN NICKEL (Ni) UNDERPLATE OVERALL.
- PRODUCT SPECIFICATION: PS-30700-0001
- PACKAGING SPECIFICATION: TUBE: PK-30907-227. TRAY: PK-30907-260
- MATES WITH: SERIES 30700. SEE SALES DRAWING SD-30700-120.
- DATECODE DESCRIPTION:
 - 1ST DIGIT: MACHINE ID# (ALWAYS WILL BE '2')
 - 2ND THROUGH 4TH DIGIT: DAY# OF THE CALENDAR YEAR (EXAMPLE: FEB, 3RD = '034')
 - 5TH DIGIT: LAST DIGIT OF THE CALENDAR YEAR (EXAMPLE: 1999 = '9')
 - 6TH THROUGH 7TH DIGIT: HOUR OF THE DAY.
- RECOMMENDED OPTIONAL SCREW: M2 x 0.89, 6mm IN LENGTH, PAN COLLAR HEAD, 6 LOBE. TORQUE: 7 NEWTON CENTIMETERS

BELOW VIEWS APPLY TO
30700-5067/8/9 PART NUMBERS

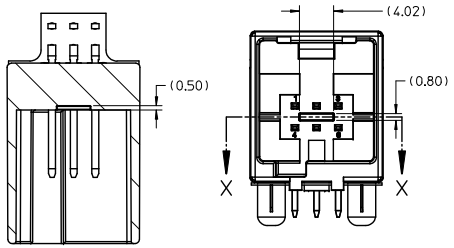

SECTION X-X
SCALE 3:1

SEE ECN# UAU2001-0258 EC NO: UAU2017-0015 DRWN: JFISCHER0205/06/09 CHKD: APPR: RBAUMAN 2016/07/15 B4	QUALITY SYMBOLS -0 -0	GENERAL TOLERANCES (UNLESS SPECIFIED) 4 PLACES ± --- ± --- 3 PLACES ± --- ± --- 2 PLACES ± 0.13 ± --- 1 PLACE ± 0.25 ± --- ANGULAR ± 1° DRAFT WHERE APPLICABLE MUST REMAIN WITHIN DIMENSIONS	SCALE 2:1	DESIGN UNITS METRIC	THIRD ANGLE PROJECTION	REVISE ON CAD ONLY
			DIMENSION STYLE MM ONLY		TITLE	
			DRAWN BY DATE		RCARLSON 01/03/20	
			CHECKED BY DATE		CKRISHNA 01/03/27	
APPROVED BY DATE		LGEIB 01/03/28		MATERIAL NO.	DOCUMENT NO.	SHEET NO.
				ENTER-PART	SD-30700-520	1 OF 3
THIS DRAWING CONTAINS INFORMATION THAT IS PROPRIETARY TO MOLEX INCORPORATED AND SHOULD NOT BE USED WITHOUT WRITTEN PERMISSION						

20 CIRCUIT PCB LAYOUT SHOWN BELOW

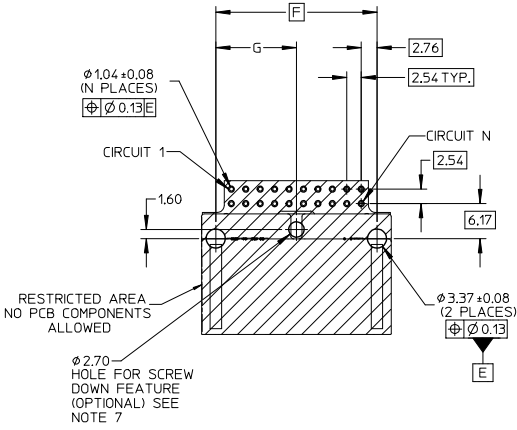

PCB LAYOUT: COMPONENT SIDE
RECOMMENDED PCB THICKNESS: 1.57±0.17

PCB LAYOUT DIMENSIONS		
CIRCUIT SIZE (N)	F	G
20	28.38	14.19
18	25.84	12.92
16	23.30	11.65
14	20.76	10.38
12	18.22	9.11
10	15.68	7.84
8	13.14	6.57
6	10.60	5.30

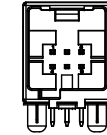

6 CIRCUIT RIGHT ANGLE HEADER 30700-5060

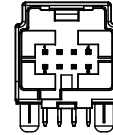

8 CIRCUIT RIGHT ANGLE HEADER 30700-5080

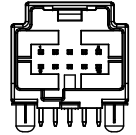

10 CIRCUIT RIGHT ANGLE HEADER 30700-5100

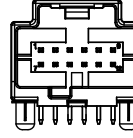

12 CIRCUIT RIGHT ANGLE HEADER 30700-5120

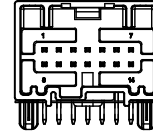

14 CIRCUIT RIGHT ANGLE HEADER 30700-5147

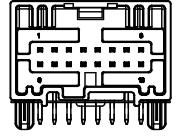

16 CIRCUIT RIGHT ANGLE HEADER 30700-5167

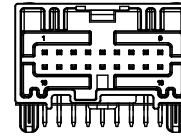

18 CIRCUIT RIGHT ANGLE HEADER 30700-5187

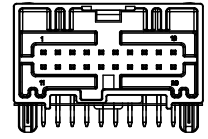

20 CIRCUIT RIGHT ANGLE HEADER 30700-5207

SEE ECN# UAU2001-0258 EC NO: UAU2017-0015 DRAWN: JFISCHER 2015/06/09 CHKD: APPR: RBAUMAN 2016/07/15 DESCRIPTION:	QUALITY SYMBOLS	GENERAL TOLERANCES (UNLESS SPECIFIED)	SCALE 2:1	DESIGN UNITS METRIC	THIRD ANGLE PROJECTION	REVISE ON CAD ONLY
	▽-0	4 PLACES ± --- ± ---	mm	MM ONLY	TITLE 6-20 CIRCUIT RIGHT ANGLE HEADER ASSEMBLY	MOLEX MOLEX INCORPORATED
	▽-0	3 PLACES ± --- ± ---	INCH	DIMENSION STYLE		
		2 PLACES ± 0.13 ± ---	ANGULAR ± 1°	DRAWN BY DATE	DATE	MATERIAL NO.
	1 PLACE ± 0.25 ± ---	DRAFT WHERE APPLICABLE MUST REMAIN WITHIN DIMENSIONS	CHECKED BY DATE	DATE	ENTER-PART	SD-30700-520
			APPROVED BY DATE	DATE	SHEET NO. 2 OF 3	
			THIS DRAWING CONTAINS INFORMATION THAT IS PROPRIETARY TO MOLEX INCORPORATED AND SHOULD NOT BE USED WITHOUT WRITTEN PERMISSION			

PACKAGING		POLARIZATION OPTIONS & CIRCUIT SIZE		PRODUCT DIMENSIONS						
ASSEMBLY P/N TRAY PACKED	ASSEMBLY P/N TUBE PACKED	RIGHT ANGLE HEADER ASSEMBLY (POLARIZATION OPTIONS)	CIRCUIT SIZE	A	B	(C)	D	(E)	HOUSING COLOR	STATUS
30700-5207	30700-5204	POLARIZATION OPTION #1	20	33.39	22.86	31.14	28.38	12.57	GRAY	RELEASED
30700-5208	30700-5205	POLARIZATION OPTION #2	20	33.39	22.86	31.14	28.38	15.57	BLACK	RELEASED
30700-5209	30700-5206	POLARIZATION OPTION #3	20	33.39	22.86	31.14	28.38	18.57	NATURAL (CREAM)	RELEASED
30700-5187	30700-5184	POLARIZATION OPTION #1	18	30.85	20.32	28.60	25.84	11.31	GRAY	RELEASED
30700-5188	30700-5185	POLARIZATION OPTION #2	18	30.85	20.32	28.60	25.84	14.31	BLACK	RELEASED
30700-5189	30700-5186	POLARIZATION OPTION #3	18	30.85	20.32	28.60	25.84	17.31	NATURAL (CREAM)	RELEASED
30700-5167	30700-5164	POLARIZATION OPTION #1	16	28.31	17.78	26.06	23.30	10.04	GRAY	RELEASED
30700-5168	30700-5165	POLARIZATION OPTION #2	16	28.31	17.78	26.06	23.30	13.04	BLACK	RELEASED
30700-5169	30700-5166	POLARIZATION OPTION #3	16	28.31	17.78	26.06	23.30	16.04	NATURAL (CREAM)	RELEASED
30700-5147	30700-5144	POLARIZATION OPTION #1	14	25.77	15.24	23.52	20.76	8.77	GRAY	RELEASED
30700-5148	30700-5145	POLARIZATION OPTION #2	14	25.77	15.24	23.52	20.76	11.77	BLACK	RELEASED
30700-5149	30700-5146	POLARIZATION OPTION #3	14	25.77	15.24	23.52	20.76	14.77	NATURAL (CREAM)	RELEASED
30700-5120	30700-5124	POLARIZATION OPTION #1	12	23.23	12.70	20.98	18.22	7.50	GRAY	RELEASED
30700-5121	30700-5125	POLARIZATION OPTION #2	12	23.23	12.70	20.98	18.22	10.50	BLACK	RELEASED
30700-5122	30700-5126	POLARIZATION OPTION #3	12	23.23	12.70	20.98	18.22	13.50	NATURAL (CREAM)	RELEASED
30700-5100	30700-5104	POLARIZATION OPTION #1	10	20.69	10.16	18.44	15.68	6.23	GRAY	RELEASED
30700-5101	30700-5105	POLARIZATION OPTION #2	10	20.69	10.16	18.44	15.68	9.23	BLACK	RELEASED
30700-5102	30700-5106	POLARIZATION OPTION #3	10	20.69	10.16	18.44	15.68	12.23	NATURAL (CREAM)	RELEASED
30700-5080	30700-5084	POLARIZATION OPTION #1	8	18.15	7.62	15.90	13.14	4.96	GRAY	RELEASED
30700-5081	30700-5085	POLARIZATION OPTION #2	8	18.15	7.62	15.90	13.14	7.96	BLACK	RELEASED
30700-5082	30700-5086	POLARIZATION OPTION #3	8	18.15	7.62	15.90	13.14	10.96	NATURAL (CREAM)	RELEASED
30700-5060	30700-5064	POLARIZATION OPTION #1	6	15.61	5.08	13.36	10.60	3.69	GRAY	RELEASED
30700-5061	30700-5065	POLARIZATION OPTION #2	6	15.61	5.08	13.36	10.60	6.69	BLACK	RELEASED
30700-5062	30700-5066	POLARIZATION OPTION #3	6	15.61	5.08	13.36	10.60	9.69	NATURAL (CREAM)	RELEASED
30700-5067	TBD	POLARIZATION OPTION #1 (MOAT)	6	15.61	5.08	13.36	10.60	3.69	GRAY	RELEASED
30700-5068	TBD	POLARIZATION OPTION #2 (MOAT)	6	15.61	5.08	13.36	10.60	6.69	BLACK	RELEASED
30700-5069	TBD	POLARIZATION OPTION #3 (MOAT)	6	15.61	5.08	13.36	10.60	9.69	NATURAL (CREAM)	RELEASED

ENTER DESCRIPTION EC NO: 040207-0015 DRAWN BY: JF SHERO1 2015/06/09 CHKD: APPR: BALWAN 2016/07/15 B4	QUALITY SYMBOLS 	GENERAL TOLERANCES (UNLESS SPECIFIED)		DIMENSION STYLE MM ONLY		SCALE 1:1	DESIGN UNITS METRIC	THIRD ANGLE PROJECTION	
		4 PLACES ± --- ± --- 3 PLACES ± --- ± --- 2 PLACES ± 0.13 ± --- 1 PLACE ± 0.25 ± --- 0 PLACE ± --- ± ---	mm INCH	DRAWN BY R CARLSON	DATE 01/03/20	TITLE 6-20 CIRCUIT RIGHT ANGLE HEADER ASSEMBLY 			
		ANGULAR ± 1 °		CHECKED BY CKRISHNA	DATE 01/03/27				
		DRAFT WHERE APPLICABLE MUST REMAIN WITHIN DIMENSIONS		APPROVED BY LGEIB	DATE 01/03/28				
		MATERIAL NO. 9999999999	DOCUMENT NO. SD-30700-520	SHEET NO. 3 OF 3					