

Excellent Integrated System Limited

Stocking Distributor

Click to view price, real time Inventory, Delivery & Lifecycle Information:

[Molex Connector Corporation](#)
[0310721010](#)

For any questions, you can email us directly:

sales@integrated-circuit.com

20 19 18 17 16 15 14 13 12 11 10 9 8 7 6 5 4 3 2 1

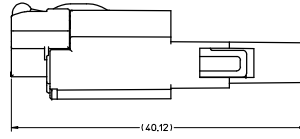
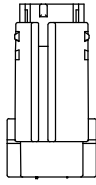

OVERALL MATED LENGTH

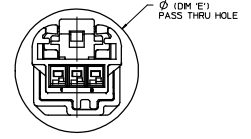

MALE AND FEMALE ASSEMBLY
PASS THRU VIEW
(CAD GENERATED)

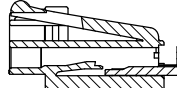
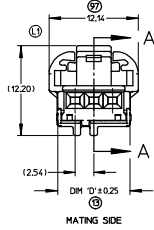
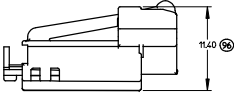

SECTION A-A
SCALE 4:1

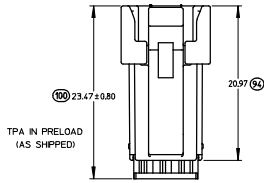

TPA IN PRELOAD
(AS SHIPPED)



WIRE SIDE

- NOTES:
1. MATERIAL: HOUSING: SPS GLASS FILLED, COLOR SEE CHART. TPA: PBT.
 2. PRODUCT SPECIFICATIONS - IN-LINE MATING INTERFACE: PS-31067-0001, - DIRECT CONNECT MATING INTERFACE: PS-3100-0001.
 3. PACKAGING SPECIFICATIONS: DRAWING PK-30907-737.
 4. MATES WITH: SEE SALES DRAWINGS SD-3110-003 (MALE IN-LINE), SD-3197-003 (RIGHT ANGLE HEADER), SD-3101-114 (VERTICAL "WINGED" HEADER), AND SD-31206-003 (VERTICAL HEADER).
 5. TERMINAL PLATING: TIN (50) OVERALL, BRITE FINISH. THICKNESS = 45 MICROMETER MINIMUM. NICKEL (N) UNDERPLATE OVERALL.
 6. PACKAGING: PLEASE REFERENCE MOLEX SPECIFICATION PS-34646-001 AVAILABLE AT WWW.MOLEX.COM. (REFERENCE: TPAs THAT ARE FOUND IN SEATED (FINAL LOCK) POSITION)
 7. APPLICATION SPECIFICATION: AS-31067-100.

ENTER DESCRIPTION EC NO. UAL2008-0767 DRAWN: MALINGA 2008/07/08 CHECKED: 2008/07/09 APPROVED: 2008/07/09 DESIGNED:	QUALITY SYMBOLS	GENERAL TOLERANCES (UNLESS SPECIFIED)	DIMENSION STYLE	SCALE	DESIGN UNITS	THIRD ANGLE PROJECTION
	$\nabla=0$ $\nabla=0$	mm INCH 4 PLACES +--- +--- 3 PLACES +--- +--- 2 PLACES ±0.13 ±--- 1 PLACE ±0.25 ±--- ANGULAR ±1/2°	MM ONLY	1:1	METRIC	<input checked="" type="checkbox"/> THIRD ANGLE PROJECTION
	DRAWN BY: RD1CK01 CHECKED BY: DILLON APPROVED BY:	DATE: 6/22/2007 DATE: 6/22/2007 DATE:	TITLE: FEMALE ASSEMBLY CHARTED SALES DRAWING			
	MATERIAL NO. SEE CHART SIZE D THIS DRAWING CONTAINS INFORMATION THAT IS PROPRIETARY TO MOLEX INCORPORATED AND SHOULD NOT BE USED WITHOUT WRITTEN PERMISSION	MOLEX MOLEX INCORPORATED DOCUMENT NO. SD-31109-003 SHEET NO. 1 OF 4				

19 18 17 16 15 14 13 12 11 10 9 8 7 6 5 4 3 2 1

FEMALE VIEWED FROM MATING SIDE

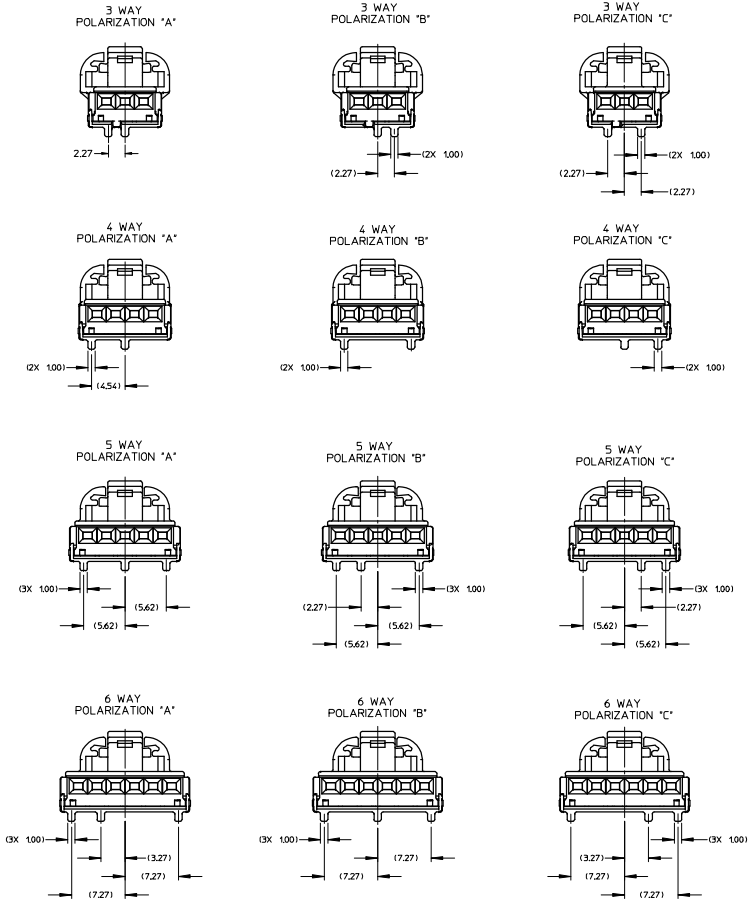

BILL OF MATERIALS						MATING ASSEMBLIES PART NUMBERS					
ASSEMBLY PART NUMBER	DESCRIPTION	PART NUMBER	DESCRIPTION	COLOR	DM 'D'	DM 'E'	INLINE MALE ASSEMBLY W/O XMAS SLOT	INLINE MALE ASSEMBLY W/ XMAS SLOT	RIGHT ANGLE MALE HEADER ASSEMBLY	VERTICAL MALE HEADER ASSEMBLY	VERTICAL MALE WINGED HEADER ASSY
31067-1010	3 WAY FEMALE ASSEMBLY POLARIZATION 'A'	31111-0030	FEMALE HOUSING	BLACK	9.80	16.76	31067-1040	31067-1070	31100-0030 NOT TOOLED	31101-0030 NOT TOOLED	TBD
		31113-0030	TPA	NATURAL (WHITE)							
31067-1011	3 WAY FEMALE ASSEMBLY POLARIZATION 'B'	31111-0031	FEMALE HOUSING	GRAY	9.80	16.76	31067-1041	31067-1071	31100-0031 NOT TOOLED	31101-0031 NOT TOOLED	TBD
		31113-0030	TPA	NATURAL (WHITE)							
31067-1012	3 WAY FEMALE ASSEMBLY POLARIZATION 'C'	31111-0032	FEMALE HOUSING	BROWN	9.80	16.76	31067-1042	31067-1072	31100-0032 NOT TOOLED	31101-0032 NOT TOOLED	TBD
		31113-0030	TPA	NATURAL (WHITE)							
31068-1010	4 WAY FEMALE ASSEMBLY POLARIZATION 'A'	31157-0040	FEMALE HOUSING	BLACK	12.34	18.25	31068-1040	31068-1070	31100-0040	31101-0040	31101-1140
		31159-0040	TPA	NATURAL (WHITE)							
31068-1011	4 WAY FEMALE ASSEMBLY POLARIZATION 'B'	31157-0041	FEMALE HOUSING	GRAY	12.34	18.25	31068-1041	31068-1071	31100-0041	31101-0041	31101-1240
		31158-0040	TPA	NATURAL (WHITE)							
31068-1012	4 WAY FEMALE ASSEMBLY POLARIZATION 'C'	31157-0042	FEMALE HOUSING	BROWN	12.34	18.25	31068-1042	31068-1072	31100-0042	31101-0042	31101-1340
		31158-0040	TPA	NATURAL (WHITE)							
31072-1010	5 WAY FEMALE ASSEMBLY POLARIZATION 'A'	31160-0050	FEMALE HOUSING	BLACK	14.88	20.25	31072-1040	31072-1070	31100-0050 NOT TOOLED	31101-0050 NOT TOOLED	TBD
		31161-0050	TPA	NATURAL (WHITE)							
31072-1011	5 WAY FEMALE ASSEMBLY POLARIZATION 'B'	31160-0051	FEMALE HOUSING	GRAY	14.88	20.25	31072-1041	31072-1071	31100-0051 NOT TOOLED	31101-0051 NOT TOOLED	TBD
		31161-0050	TPA	NATURAL (WHITE)							
31072-1012	5 WAY FEMALE ASSEMBLY POLARIZATION 'C'	31160-0052	FEMALE HOUSING	BROWN	14.88	20.25	31072-1042	31072-1072	31100-0052 NOT TOOLED	31101-0052 NOT TOOLED	TBD
		31161-0050	TPA	NATURAL (WHITE)							
31073-1010	6 WAY FEMALE ASSEMBLY POLARIZATION 'A'	31163-0060	FEMALE HOUSING	BLACK	17.42	22.75	31073-1040	31073-1070	31100-0060 NOT TOOLED	31101-0060 NOT TOOLED	TBD
		31164-0060	TPA	NATURAL (WHITE)							
31073-1011	6 WAY FEMALE ASSEMBLY POLARIZATION 'B'	31163-0061	FEMALE HOUSING	GRAY	17.42	22.75	31073-1041	31073-1071	31100-0061 NOT TOOLED	31101-0061 NOT TOOLED	TBD
		31164-0060	TPA	NATURAL (WHITE)							
31073-1012	6 WAY FEMALE ASSEMBLY POLARIZATION 'C'	31163-0062	FEMALE HOUSING	BROWN	17.42	22.75	31073-1042	31073-1072	31100-0062 NOT TOOLED	31101-0062 NOT TOOLED	TBD
		31164-0060	TPA	NATURAL (WHITE)							

ENTER DESCRIPTION EC: NO. VAL2008-0767 DRN: N/A/IN/CHINA 2008/07/08 CHK: KBD/CLK APP: P/S/MS/CS/UL 2008/07/09 REV:	QUALITY SYMBOLS ▽=0 ▽=0	GENERAL TOLERANCES (UNLESS SPECIFIED) 4 PLACES ±.05 INCH 3 PLACES ±.05 INCH 2 PLACES ±0.13 INCH 1 PLACE ±0.25 INCH ANGULAR ±1/2°	DIMENSION STYLE MM ONLY	SCALE 1:1	DESIGN UNITS METRIC	THIRD ANGLE PROJECTION	
	DRAWN BY: BDI (K01) DATE: 6/22/2007 CHECKED BY: DILLON DATE: 6/22/2007 APPROVED BY:	FEMALE ASSEMBLY CHARTED SALES DRAWING		MOLEX INCORPORATED			
	MATERIAL NO. SEE CHART SIZE D THIS DRAWING CONTAINS INFORMATION THAT IS PROPRIETARY TO MOLEX INCORPORATED AND SHOULD NOT BE USED WITHOUT WRITTEN PERMISSION	DOCUMENT NO. SD-31109-003	SHEET NO. 2 OF 4				

REFERENCE ONLY

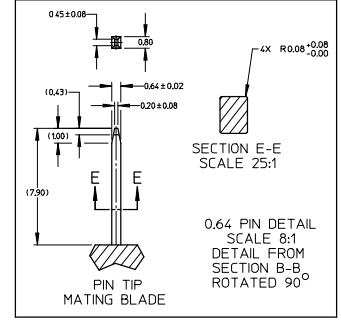
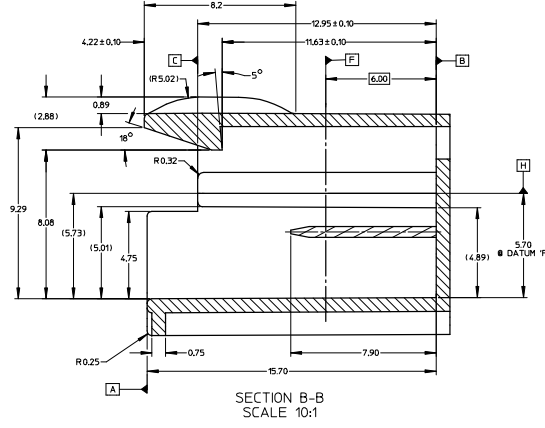
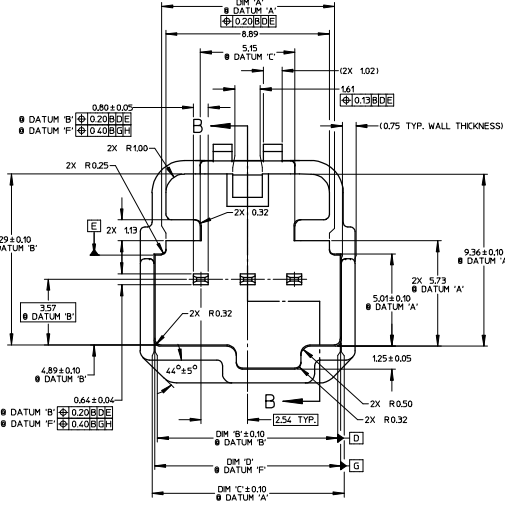

RECOMMENDED DIRECT CONNECT INFO
FOR MATING FEMALE PARTS ONLY

DIMENSIONS FOR DIRECT CONNECT

CIRCUIT SIZE	DM 'A'	DM 'B'	DM 'C'	DM 'D'
3	8.89	10.05	10.19	10.11
4	11.20	12.59	12.73	12.65
5	13.74	15.13	15.27	15.19
6	16.28	17.67	17.81	17.73

ENTER DESCRIPTION EC NO. UAD2008-0767 DRAWN/MACHINA 2008/07/08 CHK/BDLCK 2008/07/09 APPR/SMBRECU 2008/07/09 REV	QUALITY SYMBOLS ▽=0 ▽=0	GENERAL TOLERANCES (UNLESS SPECIFIED) 4 PLACES ±.005 ±.005 3 PLACES ±.005 ±.005 2 PLACES ±.015 ±.015 1 PLACE ±.025 ±.025 ANGULAR ±1/2°	DIMENSION STYLE MM ONLY	SCALE 1:1	DESIGN UNITS METRIC	THIRD ANGLE PROJECTION	
	DRAWN BY BD1 (K01)	DATE 6/22/2007	TITLE FEMALE ASSEMBLY CHARTED SALES DRAWING	MOLEX INCORPORATED	DOCUMENT NO. SD-31109-003	SHEET NO. 3 OF 4	
	CHECKED BY DILLON	DATE 6/22/2007	APPROVED BY	SEE CHART	THIS DRAWING CONTAINS INFORMATION THAT IS PROPRIETARY TO MOLEX INCORPORATED AND SHOULD NOT BE USED WITHOUT WRITTEN PERMISSION		
	MATERIAL NO.	SIZE	DRAFT WHERE APPLICABLE MUST REMAIN WITHIN DIMENSIONS				

REFERENCE ONLY

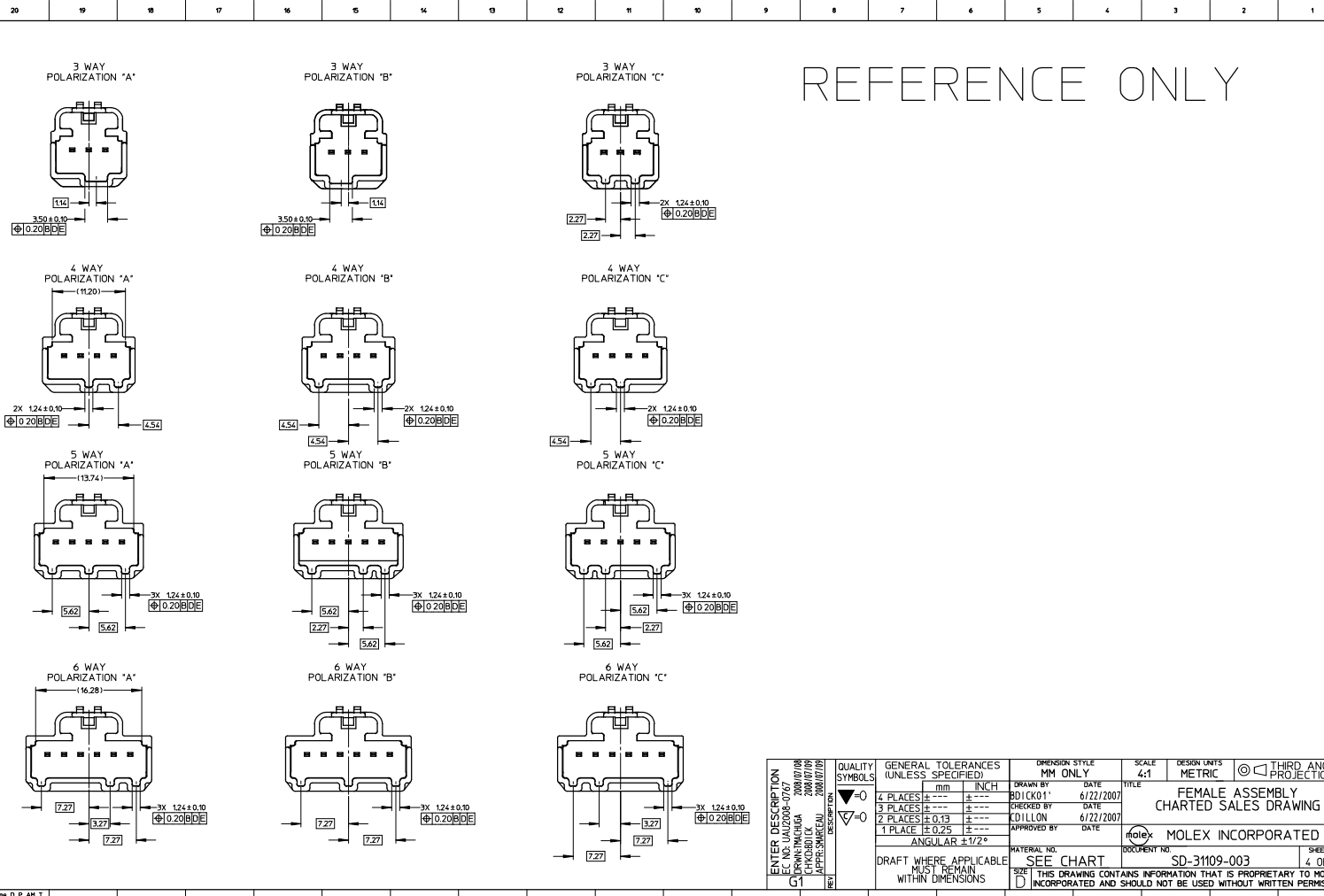

ENTER DESCRIPTION EC INCL 0310721010 2008/07/08 DORRINI/MALDUGA 2008/07/09 CHIKOBILEK 2008/07/09 APPROVED/REV 2008/07/09 G1	QUALITY SYMBOLS ▽=0 ▽=0	GENERAL TOLERANCES (UNLESS SPECIFIED) 4 PLACES ± 0.15 3 PLACES ± 0.13 2 PLACES ± 0.13 1 PLACE ± 0.25 ANGULAR ± 1/2°	DIMENSION STYLE MM ONLY	SCALE 4:1 DESIGN UNITS METRIC THIRD ANGLE PROJECTION	
	DRAWN BY: RD1CK01 DATE: 6/22/2007 CHECKED BY: CDILLON DATE: 6/22/2007 APPROVED BY:	TITLE: FEMALE ASSEMBLY CHARTED SALES DRAWING	MATERIAL NO: SEE CHART DRAFT WHERE APPLICABLE MUST REMAIN WITHIN DIMENSIONS	DOCUMENT NO: SD-31109-003 SHEET NO: 4 OF 4	MOLEX INCORPORATED
	THIS DRAWING CONTAINS INFORMATION THAT IS PROPRIETARY TO MOLEX INCORPORATED AND SHOULD NOT BE USED WITHOUT WRITTEN PERMISSION				
	© 2007 MOLEX INCORPORATED				