

Excellent Integrated System Limited

Stocking Distributor

Click to view price, real time Inventory, Delivery & Lifecycle Information:

[Molex Connector Corporation](#)
[0330013005](#)

For any questions, you can email us directly:

sales@integrated-circuit.com

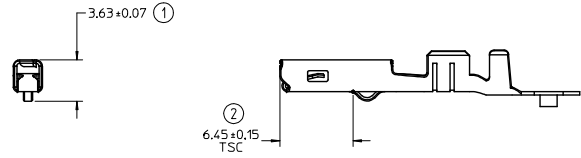

DIMENSIONS FOR LARGE POLARIZATION RIB TERMINAL ONLY

STAMP PLATING TYPE
Sn-TIN, Au-GOLD OR
Ag-SILVER IN THIS
AREA

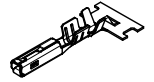
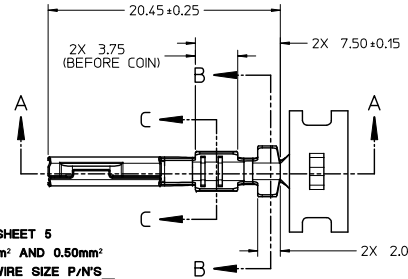

SCALE 2:1



SECTION B-B
SCALE 5:1



SECTION C-C
SCALE 5:1

CARRIER BUMP DIRECTION
POINTS DOWN FOR TIN PLATED TERMINALS
POINTS UP FOR PRECIOUS PLATED TERMINALS

NOTES: (UNLESS OTHERWISE SPECIFIED)

1. MATING TERMINAL SHOWN ON SD-33000-001
2. MATERIAL: ASTM B422, UNS C19025, HR04
THICKNESS: 0.30 mm ±0.01
TEMPER: FULL HARD (REF)
TENSILE: 496 MIN MPa
3. TIN PLATED TERMINAL FINISH:
OVERALL UNDERPLATE ELECTRODEPOSITED NICKEL
OVERALL ELECTRODEPOSITED REFLOW TIN
4. GOLD PLATED TERMINAL FINISH:
OVERALL UNDERPLATE ELECTRODEPOSITED DUCTILE SULFAMATE NICKEL
CONTACT AREA - ELECTRODEPOSITED GOLD
GRP AREA - ELECTRODEPOSITED 100% TIN MATTE FINISH
5. SILVER PLATED TERMINAL FINISH:
OVERALL UNDERPLATE ELECTRODEPOSITED DUCTILE SULFAMATE NICKEL
CONTACT AREA - ELECTRODEPOSITED PURE SILVER (0.5% MAX IMPURITIES) SEM-BRIGHT FINISH
- SILVER ANTI-TARNISH + EVABRITE
GRP AREA - ELECTRODEPOSITED 100% TIN MATTE FINISH
6. MEETS PERFORMANCE SPECIFICATION FOR CABLE TO TERMINAL ELECTRICAL CRIMPS PER SAE/USCAR-21 (8/2000)
7. MEETS PERFORMANCE STANDARD FOR AUTOMOTIVE ELECTRICAL CONNECTOR SYSTEMS FOR SAE/USCAR-2, REV. 4 (TEMP CLASS 3) (5/2004)
8. MEETS ELECTRICAL CONNECTION SYSTEM DESIGN SPECIFICATION (ISDS) REV.11 (5/2002)
9. MEETS FIELD CORRELATED LIFE TEST (FCLT) PER SAE/USCAR-20 (6/2004)
10. MEETS WIRING COMPONENT DESIGN GUIDELINES SAE/USCAR-12 REV 2 (12/2001)
11. TSC ON A DIMENSION TO BE INTERPRETED AS DISTANCE TO A THEORETICAL SHARP CORNER AS IF THE RADIUS WERE NOT PRESENT
12. REFERENCE 9786-14474-AAB FOR LARGE POLARIZATION RIB CAVITY SPECIFICATION
13. INSERTION FORCE (TINI AVG. FROM PV TESTING - 3.8N LARGE POLARIZATION RIB
3.5N SMALL POLARIZATION RIB (REFERENCE))
14. ALL DIMENSIONS EXCEPT (1), (2), (3) & (4) ARE COMMON TO BOTH SMALL AND LARGE POLARIZATION RIB TERMINALS
15. REFERENCE PK-31000-516 FOR REEL DIRECTION
16. REFERENCE AS-33012-002 FOR CRIMP INFORMATION

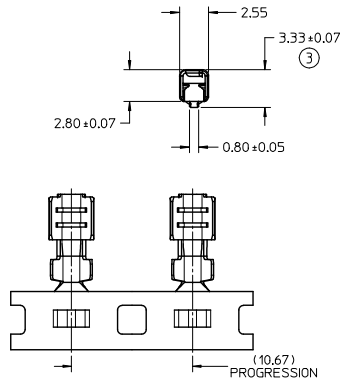

SEE SHEET 5
0.35mm² AND 0.50mm²
ISO WIRE SIZE P/N/S
33012-2004/3004
33001-4005/5005

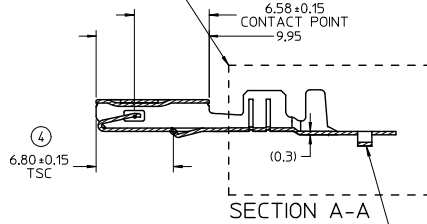

ENTER DESCRIPTION EC NO: UAU02014-0473 DRAWN BY: JENNINGS01 2013/09/18 CHKD: APPR: MOSER 2014/01/03	QUALITY SYMBOLS 	GENERAL TOLERANCES (UNLESS SPECIFIED)		DIMENSION STYLE		SCALE	DESIGN UNITS	THIRD ANGLE PROJECTION			
				MM ONLY		4:1	METRIC				
				DRAWN BY: L. PULLIAM DATE: 2005/06/21		TITLE: MX150 RECEPTACLE TERMINAL					
				CHECKED BY: A. DHIR DATE: 2005/06/21		APPROVED BY: B. MOSER DATE: 2005/06/22		molex MOLEX INCORPORATED		SHEET NO. 1 OF 5	
		DRAFT WHERE APPLICABLE MUST REMAIN WITHIN DIMENSIONS		SEE TABLE		DOCUMENT NO. SD-33012-002		THIS DRAWING CONTAINS INFORMATION THAT IS PROPRIETARY TO MOLEX INCORPORATED AND SHOULD NOT BE USED WITHOUT WRITTEN PERMISSION			

FAMILY	GENDER	SEALING	PLATING	PART NUMBER	PAYOFF DIRECTION	GRIP CODE	WIRE SIZES*	A +0.30	B ±0.30	C +0.30	D ±0.30	SPECIAL CHARACTERISTICS
MX150	RECEPTACLE	MAT SEAL	Sn	33012-2001	RIGHT (B)	14	16/14AWG	3.9	4.4	1.7	1.6	HIGH PERFORMANCE Sn
				33012-3001	LEFT (D)		150-2.00mm ²					
				33012-2002	RIGHT (B)	18	20/18AWG	3.3	3.1	1.3	1.4	
				33012-3002	LEFT (D)		0.75-1.00mm ²					
				33012-2003	RIGHT (B)	22	22AWG	2.5	2.6	0.9	1.0	
				33012-3003	LEFT (D)							
			33012-2004	RIGHT (B)	M3	0.35-0.50mm ²	2.5	2.7	0.9	1.54 ±0.1		
			33012-3004	LEFT (D)								
			33001-2003	RIGHT (B)	14	16/14AWG	3.9	4.4	1.7	1.6	HIGH PERFORMANCE Au	
			33001-3003	LEFT (D)		150-2.00mm ²						
			33001-2004	RIGHT (B)	18	20/18AWG	3.3	3.1	1.3	1.4		
			33001-3004	LEFT (D)		0.75-1.00mm ²						
			33001-2005	RIGHT (B)	22	22AWG	2.5	2.6	0.9	1.0		
			33001-3005	LEFT (D)								
			33001-2006	RIGHT (B)	M3	0.35-0.50mm ²	2.5	2.7	0.9	1.54 ±0.1		
			33001-3006	LEFT (D)								
			33001-4001	RIGHT (B)	14	16/14AWG	3.9	4.4	1.7	1.6	HIGH PERFORMANCE Ag	
			33001-5001	LEFT (D)		150-2.00mm ²						
			33001-4002	RIGHT (B)	18	20/18AWG	3.3	3.1	1.3	1.4		
			33001-5002	LEFT (D)		0.75-1.00mm ²						
			33001-4003	RIGHT (B)	22	22AWG	2.5	2.6	0.9	1.0		
			33001-5003	LEFT (D)								
			33001-4005	RIGHT (B)	M3	0.35-0.50mm ²	2.5	2.7	0.9	1.54 ±0.1		
			33001-5005	LEFT (D)								
LARGE POLARIZATION RIB - NOT TO BE USED IN MX150 SEALED CONNECTORS												
MX150	RECEPTACLE	UNSEALED	Sn	33012-2021	RIGHT (B)	14	16/14AWG	3.9	4.4	1.7	1.6	HIGH PERFORMANCE Sn
				33012-3021	LEFT (D)		150-2.00mm ²					
				33012-2022	RIGHT (B)	18	20/18AWG	3.3	3.1	1.3	1.4	
				33012-3022	LEFT (D)		0.75-1.00mm ²					
				33012-2023	RIGHT (B)	22	22AWG	2.5	2.6	0.9	1.0	
				33012-3023	LEFT (D)							
			33001-2021	RIGHT (B)	14	16/14AWG	3.9	4.4	1.7	1.6	HIGH PERFORMANCE Au	
			33001-3021	LEFT (D)		150-2.00mm ²						
			33001-2022	RIGHT (B)	18	20/18AWG	3.3	3.1	1.3	1.4		
			33001-3022	LEFT (D)		0.75-1.00mm ²						
			33001-2023	RIGHT (B)	22	22AWG	2.5	2.6	0.9	1.0		
			33001-3023	LEFT (D)								
			33001-4021	RIGHT (B)	14	16/14AWG	3.9	4.4	1.7	1.6	HIGH PERFORMANCE Ag	
			33001-5021	LEFT (D)		150-2.00mm ²						
			33001-4022	RIGHT (B)	18	20/18AWG	3.3	3.1	1.3	1.4		
			33001-5022	LEFT (D)		0.75-1.00mm ²						
			33001-4023	RIGHT (B)	22	22AWG	2.5	2.6	0.9	1.0		
			33001-5023	LEFT (D)								

* REFERENCE AS-33012-002 FOR SPECIFIC WIRE TYPES

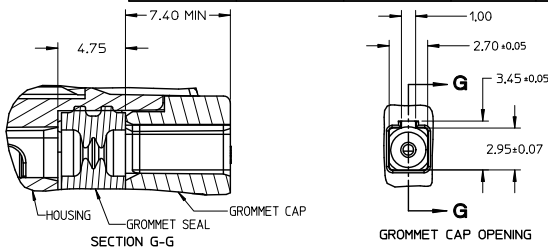

GROMMET SEAL / CAP CONFIGURATION TO MODIFY LARGE POLARIZATION RIB CAVITY TO ACCEPT SMALL POLARIZATION RIB APPLICATIONS

ENTER DESCRIPTION EC NO: 0A02014-0473 DRAWING REVISIONS: 2013/09/18 CHKD: APPR: BOMSER 2014/01/03 REV	QUALITY SYMBOLS 	GENERAL TOLERANCES (UNLESS SPECIFIED)		DIMENSION STYLE MM ONLY		SCALE	DESIGN UNITS	THIRD ANGLE PROJECTION			
		4 PLACES ± 0.10 ± 0.005 3 PLACES ± 0.05 ± 0.005 2 PLACES ± 0.10 ± 0.005 1 PLACE ± 0.3 ± 0.005		DRAWN BY: L. PULLIAM DATE: 2005/06/21 CHECKED BY: A. DHIR DATE: 2005/06/21 APPROVED BY: B. MOSER DATE: 2005/06/22		METRIC	MX150 RECEPTACLE TERMINAL				
		ANGULAR ± 3°		MATERIAL NO.		DOCUMENT NO.		MOLEX INCORPORATED			
		DRAFT WHERE APPLICABLE MUST REMAIN WITHIN DIMENSIONS		SEE TABLE		SD-33012-002		SHEET NO. 2 OF 5			

THIS CHECKING - AID IS FOR SMALL POLARIZATION RIB TERMINALS ONLY

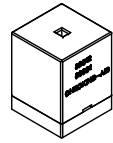

CHECKING - AID ASSEMBLY
SCALE 1:1

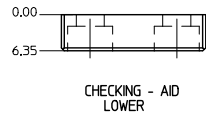
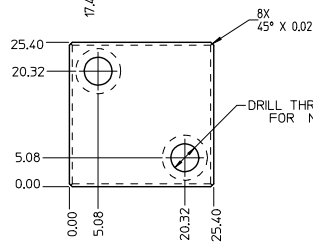
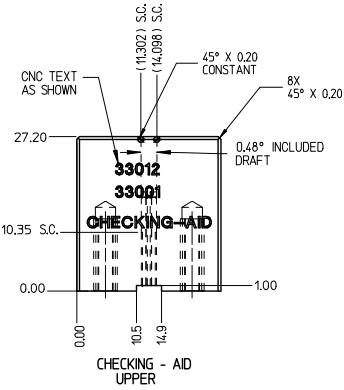
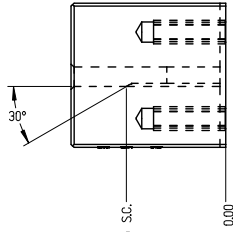
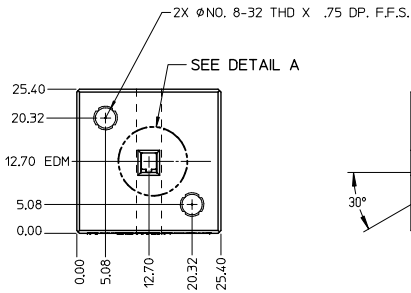

CHECKING - AID
LOWER

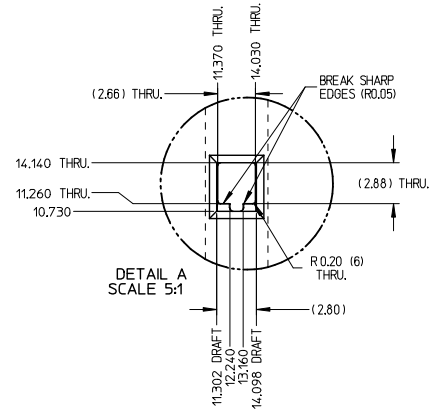

DETAIL A
SCALE 5:1

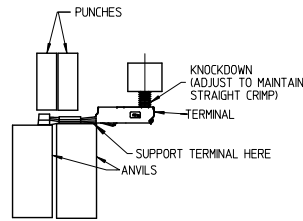

CRIMP REQUIREMENTS:

1. CRIMP STRAIGHTNESS MUST BE MAINTAINED USE A KNOCKDOWN TOOL LOCATED AS SHOWN TERMINAL BOX MUST NOT BE DEFORMED
2. AFTER CRIMPING, THE CRIMPED TERMINAL (AND UP TO 5 mm OF WIRE PAST THE INSULATOR CUTOFF TAB) MUST FIT FREELY INTO THE CHECKING-AID SHOWN ON THIS PAGE
3. FOR OTHER MECHANICAL REQUIREMENTS ON CRIMPED TERMINALS, REFER TO SAE/USCAR-21 (5-13-02) SECTIONS 4.2 (VISUAL INSPECTION), 4.2 (CROSS SECTION ANALYSIS) AND 4.4 (CONDUCTOR CRIMP PULLOUT FORCE)

UPPER & LOWER
CHECKING-AID
A2 TOOL STEEL
HARDEN & GRIND
ROCKWELL "C" 56-58

ENTER DESCRIPTION EC NO: UAU2014-0473 DRAWING NO: WJMS01 2013/09/16 CHKD: APPROB/MOSER 2014/01/03	QUALITY SYMBOLS ∇=0 ∇=0 ∇=0	GENERAL TOLERANCES (UNLESS SPECIFIED)		DIMENSION STYLE MM ONLY		SCALE 2:1	DESIGN UNITS METRIC	THIRD ANGLE PROJECTION	
		4 PLACES ± --- INCH 3 PLACES ± 0.005 ± --- 2 PLACES ± 0.10 ± --- 1 PLACE ± 0.3 ± --- ANGULAR ± 3°	DRAWN BY L. PULLIAM 2005/06/21	CHECKED BY A. DHIR 2005/06/21	APPROVED BY B. MOSER 2005/06/22	MATERIAL NO. SEE TABLE		DOCUMENT NO. SD-33012-002	TITLE MX150 RECEPTACLE TERMINAL
DRAFT WHERE APPLICABLE MUST REMAIN WITHIN DIMENSIONS		SIZE C		THIS DRAWING CONTAINS INFORMATION THAT IS PROPRIETARY TO MOLEX INCORPORATED AND SHOULD NOT BE USED WITHOUT WRITTEN PERMISSION					

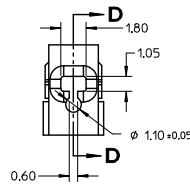
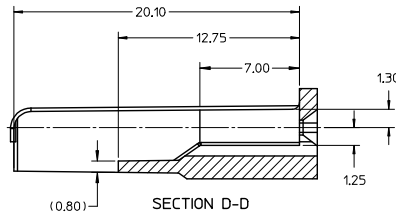
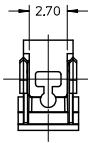

- NOTES: UNLESS OTHERWISE SPECIFIED
1. TOLERANCES: LINEAR ± 0.10
ANGULAR $\pm 3^\circ$
 2. ALL DRAFT WITHIN TOLERANCE.
 3. MAX RADI ON ALL CORNERS SHOWN SHARP: 0.10
 4. MAX FLASH PERMISSIBLE: 0.1
 5. EJECTOR PIN MARKS PERMISSIBLE IF FLUSH TO 0.25 BELOW SURFACE.
 6. MATERIAL: HOUSING/FINGER SPECIFICATION ENGINEERED FOR MATERIAL WITH THE FOLLOWING PROPERTIES:
A. FLEXURAL MODULUS = 4,500 TO 9,400 MPa
PER ASTM TEST D790
B. ELONGATION AT YIELD = 2.3% OR BETTER
PER ASTM TEST D638 TYPE V
 7. CAVITY SPEC FOR USE ONLY WITH MOLEX RECEPTACLE
TERMINAL PART NUMBERS SPECIFIED ELSEWHERE ON THIS DRAWING

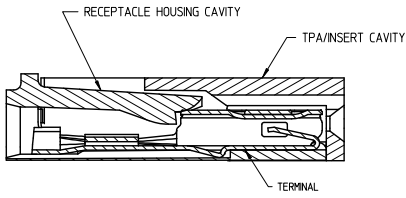
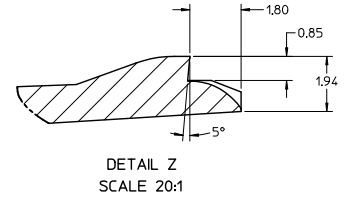
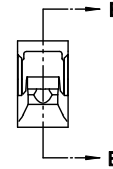
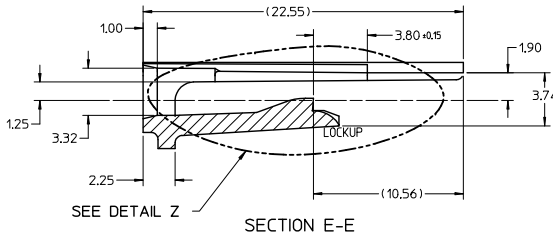
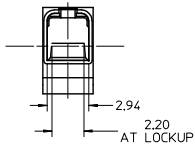

RECEPTACLE CAVITY ASSEMBLED VIEWS FOR SMALL POLARIZATION RIB APPLICATIONS FIG. 1

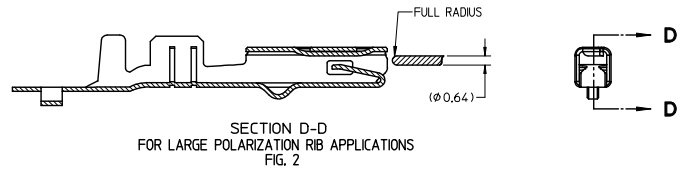
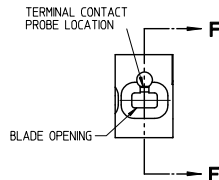

SECTION D-D FOR LARGE POLARIZATION RIB APPLICATIONS FIG. 2

PROBING DOWN THE THROAT MUST USE THIS TERMINAL PROBE
FOR PROBING INFORMATION REFERENCE MOLEX MX150 APPLICATION SPEC AS-33472-100

PREFERRED PROBING LOCATION IS NOT ON SPRING MEMBER
IF ELECTRICAL CONTINUITY PROBE TOUCHES SPRING MEMBER USE PROBING AS SHOWN IN FIG. 2

ENTER DESCRIPTION EC NO: UAU2014-0473 DRAWN/JENNINGS01 2013/09/18 CHKD: APPENBOSER 2014/01/03	QUALITY SYMBOLS ▽=0 ▽=0 ▽=0	GENERAL TOLERANCES (UNLESS SPECIFIED)		DIMENSION STYLE MM ONLY		SCALE 5:1	DESIGN UNITS METRIC	THIRD ANGLE PROJECTION	
		mm	INCH	DRAWN BY L. PULLIAM	DATE 2005/06/21	TITLE MX150 RECEPTACLE TERMINAL			
REV	DRAFT WHERE APPLICABLE MUST REMAIN WITHIN DIMENSIONS	4 PLACES	± 0.005	± 0.0005	CHECKED BY A. DHIR	DATE 2005/06/21	MOLEX INCORPORATED		
		3 PLACES	± 0.010	± 0.0010	APPROVED BY B. MOSER	DATE 2005/06/22			
		2 PLACES	± 0.10	± 0.010	MATERIAL NO.		DOCUMENT NO.	SHEET NO.	
		1 PLACE	± 0.3	± 0.03	SEE TABLE		SD-33012-002	4 OF 5	
		ANGULAR ± 3°		THIS DRAWING CONTAINS INFORMATION THAT IS PROPRIETARY TO MOLEX INCORPORATED AND SHOULD NOT BE USED WITHOUT WRITTEN PERMISSION					

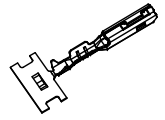

ISO VIEW
SCALE 2:1

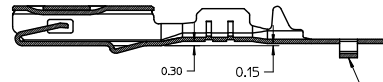
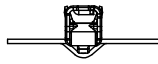
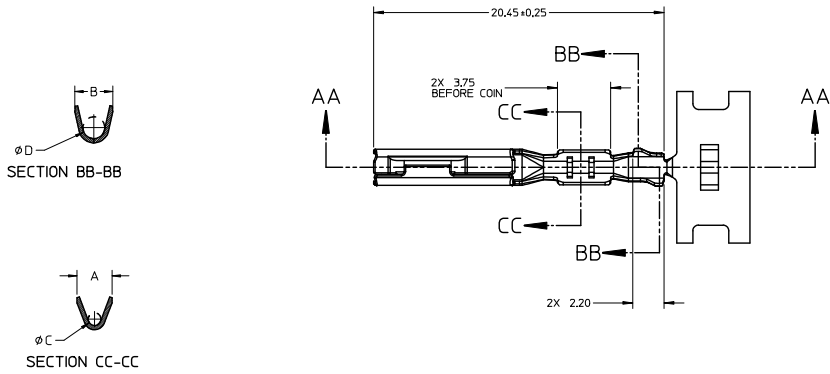

SECTION AA-AA

P/N'S **33012-2004/3004**
33001-4005/5005

CARRIER BUMP DIRECTION
POINTS DOWN FOR TIN PLATED TERMINAL
POINTS UP FOR PRECIOUS METAL PLATED TERMINAL

ENTER DESCRIPTION EC NO: 0402014-0473 DRAWN BY: JENNINGS01 2013/09/18 CHKD: APPIR/MOSER DATE: 2014/06/03	QUALITY SYMBOLS ∇=0 ∇=0 ∇=0	GENERAL TOLERANCES (UNLESS SPECIFIED)		DIMENSION STYLE MM ONLY		SCALE 5:1	DESIGN UNITS METRIC	THIRD ANGLE PROJECTION		
		4 PLACES ± --- ± ---	3 PLACES ± 0.005 ± ---	2 PLACES ± 0.10 ± ---	1 PLACE ± 0.3 ± ---	ANGULAR ± 3°	DRAWN BY L. PULLIAM DATE 2005/06/21	CHECKED BY A. DHIR DATE 2005/06/21	APPROVED BY B. MOSER DATE 2005/06/22	TITLE MX150 RECEPTACLE TERMINAL
		DRAFT WHERE APPLICABLE MUST REMAIN WITHIN DIMENSIONS			SEE TABLE		MATERIAL NO.	DOCUMENT NO.	SHEET NO.	
		THIS DRAWING CONTAINS INFORMATION THAT IS PROPRIETARY TO MOLEX INCORPORATED AND SHOULD NOT BE USED WITHOUT WRITTEN PERMISSION								5 OF 5