

## Excellent Integrated System Limited

Stocking Distributor

Click to view price, real time Inventory, Delivery & Lifecycle Information:

[Molex Connector Corporation](#)  
[0330111006](#)

For any questions, you can email us directly:

[sales@integrated-circuit.com](mailto:sales@integrated-circuit.com)

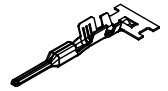
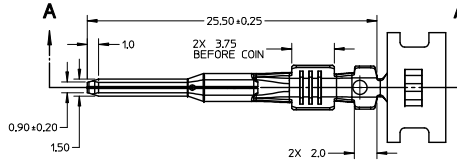
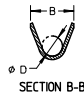

ISO VIEW  
SCALE 2:1

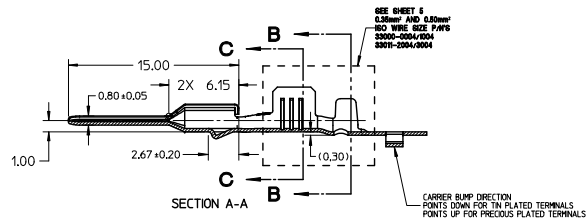
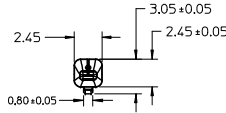
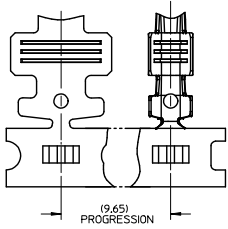

GENERAL NOTES: (UNLESS OTHERWISE SPECIFIED)

- MATING TERMINAL SHOWN ON SD-33012-002
- MATERIAL: ASTM B422, UNS C19025, HR04  
THICKNESS: 0.30 mm ±0.01  
TEMPER: FULL HARD (REF)  
TENSILE: 496-572 MPa
- TIN PLATED TERMINAL FINISH  
OVERALL UNDERPLATE ELECTRODEPOSITED NICKEL  
OVERALL ELECTRODEPOSITED REFLOW TIN
- GOLD PLATED TERMINAL FINISH  
OVERALL UNDERPLATE ELECTRODEPOSITED DUCTILE SULFAMATE NICKEL  
CONTACT AREA - ELECTRODEPOSITED GOLD  
GRP AREA - ELECTRODEPOSITED 100% TIN MATTE FINISH
- SILVER PLATED TERMINAL FINISH  
OVERALL UNDERPLATE ELECTRODEPOSITED DUCTILE SULFAMATE NICKEL  
CONTACT AREA - ELECTRODEPOSITED PURE SILVER (0.5% MAX IMPURITIES) SEMI-BRIGHT FINISH  
- SILVER ANTI-TARNISH : EVIABRITE  
GRP AREA - ELECTRODEPOSITED 100% TIN MATTE FINISH
- MEETS CRIMP PERFORMANCE SPECIFICATION SAE/USCAR-21 (8/2000)
- MEETS PERFORMANCE STANDARD FOR AUTOMOTIVE ELECTRICAL CONNECTOR SYSTEMS SAE/USCAR-2 REV 3 (APRIL 2000)
- MEETS FIELD CORRELATED LIFE TEST SAE/USCAR-20 (11/2000)
- MEETS WIRING COMPONENT DESIGN GUIDELINES SAE/USCAR-12 REV 2 (12/2000)
- MEETS ELECTRICAL CONNECTION SYSTEM DESIGN SPECIFICATION (SDS) REV 11 (5/2002)
- REFERENCE PK-31900-5/6 FOR REEL DIRECTION
- REFERENCE AS-33000-001 FOR CRIMP INFORMATION

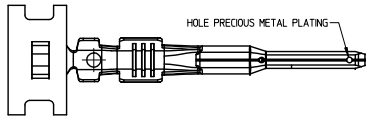

PRECIOUS METAL PLATED BLADE

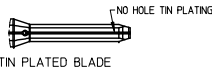

TIN PLATED BLADE

ENTER DESCRIPTION EC NO: UAU2014-0473 DRAWN BY: JENNINGS01 2013/10/07 CHKD: APPROBUSER 2014/01/03	QUALITY SYMBOLS ▽=0 ▽=0 ▽=0	GENERAL TOLERANCES (UNLESS SPECIFIED)		DIMENSION STYLE MM ONLY		SCALE 4:1	DESIGN UNITS METRIC	THIRD ANGLE PROJECTION	
		4 PLACES ± --- ± ---	3 PLACES ± --- ± ---	2 PLACES ± 0.1 ± ---	1 PLACE ± 0.3 ± ---	ANGULAR ± 3°	DRAWN BY L.PULLIAM 2006/01/31	DATE 2006/01/31	TITLE MX150 1.5MM BLADE TERMINAL
DRAFT WHERE APPLICABLE MUST REMAIN WITHIN DIMENSIONS	REV	SEE TABLE		MATERIAL NO. SD-33000-001		DOCUMENT NO. SD-33000-001		SHEET NO. 1 OF 5	
		THIS DRAWING CONTAINS INFORMATION THAT IS PROPRIETARY TO MOLEX INCORPORATED AND SHOULD NOT BE USED WITHOUT WRITTEN PERMISSION		MOLEX INCORPORATED					

FAMILY	GENDER	SEALING	PLATING	PART NUMBER	PAYOFF DIRECTION	GRIP CODE	WIRE SIZES*	A ±0.30	B ±0.30	C ±0.30	D ±0.30	SPECIAL CHARACTERISTICS
MX150	BLADE	MAT SEAL UNSEALED	Sn	33000-0001	RIGHT (B)	14	14AWG	3.9	3.8	1.7	1.6	HIGH PERFORMANCE Sn
				33000-1001	LEFT (D)		1.50-2.00mm <sup>2</sup>					
				33000-0002	RIGHT (B)	18	20/18/16AWG	3.3	3.1	1.3	1.4	
				33000-1002	LEFT (D)		0.75-1.00mm <sup>2</sup>					
				33000-0003	RIGHT (B)	22	22AWG	2.5	2.6	0.9	1.0	
				33000-1003	LEFT (D)							
			33000-0004	RIGHT (B)	M3	0.35-0.50mm <sup>2</sup>	2.5	2.7	0.9	1.54 ±0.1		
			33000-1004	LEFT (D)								
			Au	33011-1002	RIGHT (B)	14	14AWG	3.9	3.8	1.7	1.6	HIGH PERFORMANCE Au
				33011-0002	LEFT (D)		1.50-2.00mm <sup>2</sup>					
				33011-1004	RIGHT (B)	18	20/18/16AWG	3.3	3.1	1.3	1.4	
				33011-0004	LEFT (D)		0.75-1.00mm <sup>2</sup>					
				33011-1006	RIGHT (B)	22	22AWG	2.5	2.6	0.9	1.0	
				33011-0006	LEFT (D)							
			33011-1008	RIGHT (B)	M3	0.35-0.50mm <sup>2</sup>	2.5	2.7	0.9	1.54 ±0.1		
			33011-0008	LEFT (D)								
			Ag	33011-2003	RIGHT (B)	14	14AWG	3.9	3.8	1.7	1.6	HIGH PERFORMANCE Ag
				33011-3003	LEFT (D)		1.50-2.00mm <sup>2</sup>					
33011-2002	RIGHT (B)	18		20/18/16AWG	3.3	3.1	1.3	1.4				
33011-3002	LEFT (D)			0.75-1.00mm <sup>2</sup>								
33011-2001	RIGHT (B)	22		22AWG	2.5	2.6	0.9	1.0				
33011-3001	LEFT (D)											
33011-2004	RIGHT (B)	M3	0.35-0.50mm <sup>2</sup>	2.5	2.7	0.9	1.54 ±0.1					
33011-3004	LEFT (D)											

\* REFERENCE AS-33000-001 FOR SPECIFIC WIRE TYPES

ENTER DESCRIPTION EC NO: 0A02014-0475 DRAWN BY: JENNINGS01 2013/10/07 CHKD: APPROBUSER 2014/01/03 DESCRIPTION APPROBUSER REV	QUALITY SYMBOLS	GENERAL TOLERANCES (UNLESS SPECIFIED)	DIMENSION STYLE	SCALE	DESIGN UNITS	THIRD ANGLE PROJECTION
	▽=0	mm INCH	MM ONLY	METRIC		
	▽=0	4 PLACES ± --- ± ---	DRAWN BY DATE	TITLE		
	▽=0	3 PLACES ± --- ± ---	L. PULLIAM 2006/01/31	MX150 1.5MM BLADE TERMINAL		
	2 PLACES ± 0.1 ± ---	1 PLACE ± 0.3 ± ---	CHECKED BY DATE	MOLEX INCORPORATED		
	ANGULAR ± 3°		A. DHIR 2006/02/01	SD-33000-001		
			APPROVED BY DATE	SHEET NO.		
			B. MOSER 2006/02/02	2 OF 5		
			MATERIAL NO.	DOCUMENT NO.		
			SEE TABLE	THIS DRAWING CONTAINS INFORMATION THAT IS PROPRIETARY TO MOLEX INCORPORATED AND SHOULD NOT BE USED WITHOUT WRITTEN PERMISSION		

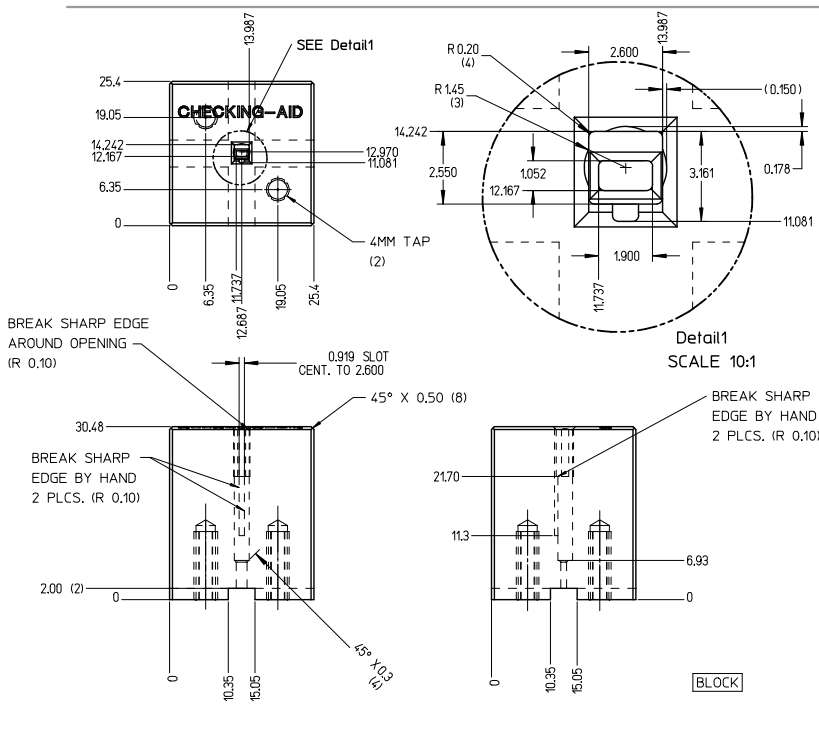

CHECKING-AID  
2 PIECE ASM. A2 TOOL STEEL  
HARDEN & GRIND TO A ROCKWELL  
HARDNESS "C" SCALE OF 56-58

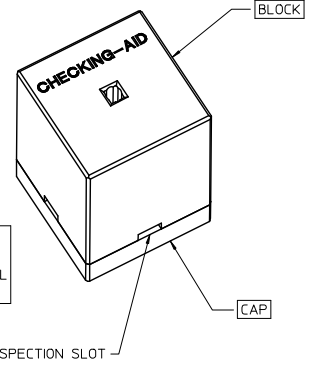

CHECKING AID TOLERANCE  
.XXX = .005  
.XX = .03  
.X = .3

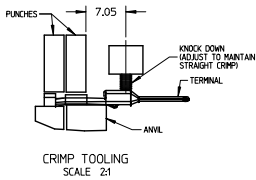
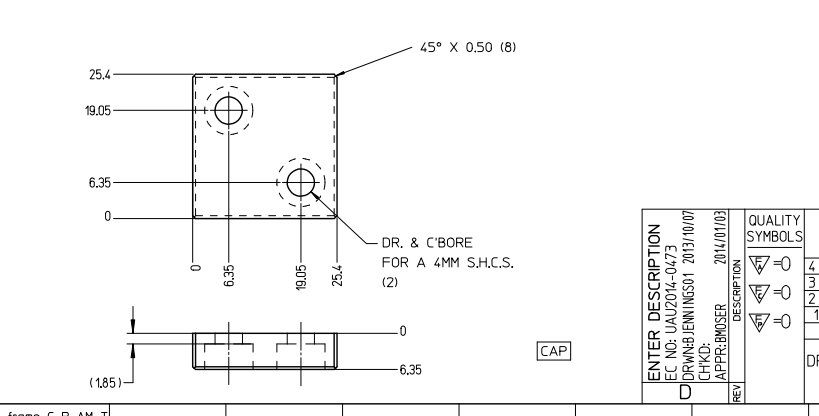

- CRIMP REQUIREMENTS:
1. CRIMP STRAIGHTNESS MUST BE MAINTAINED. USE A KNOCKDOWN TOOL LOCATED AS SHOWN. TERMINAL BOX MUST NOT BE DEFORMED.
  2. AFTER CRIMPING, THE TERMINAL AND WIRE MUST FIT FREELY INTO THE CHECKING AID 33000-700. PROPER INSERTION DEPTH IS MET WHEN BLADE TIP STOPS ON CAP. SLOTS PROVIDED TO VISUALLY INSPECT STOPPAGE OF PIN TIP.
  3. FOR OTHER MECHANICAL REQUIREMENTS ON CRIMPED TERMINALS, REFER TO SAE/USCAR-21 (5-13-02) SECTIONS 4.2 (VISUAL INSPECTION), 4.3 (CROSS SECTION ANALYSIS) AND 4.4 (CONDUCTOR CRIMP PULLOUT FORCE).

ENTER DESCRIPTION EC NO: UAU2014-0473 DRAWN BY: JENNINGS01 2013/10/07 CHKD: APPROVER APPROVED BY: B. MOSER 2014/01/03	QUALITY SYMBOLS ▽=0 ▽=0 ▽=0	GENERAL TOLERANCES (UNLESS SPECIFIED)		DIMENSION STYLE MM ONLY		SCALE 2:1	DESIGN UNITS METRIC	THIRD ANGLE PROJECTION						
		4 PLACES ± .005	3 PLACES ± .005	2 PLACES ± 0.1	1 PLACE ± 0.3	ANGULAR ± 3°	DRAWN BY L. PULLIAM 2006/01/31	CHECKED BY A. DHIR 2006/02/01	APPROVED BY B. MOSER 2006/02/02	TITLE MX150 1.5MM BLADE TERMINAL	MATERIAL NO. SEE TABLE	DOCUMENT NO. SD-33000-001	SHEET NO. 3 OF 5	
DRAFT WHERE APPLICABLE MUST REMAIN WITHIN DIMENSIONS		THIS DRAWING CONTAINS INFORMATION THAT IS PROPRIETARY TO MOLEX INCORPORATED AND SHOULD NOT BE USED WITHOUT WRITTEN PERMISSION												

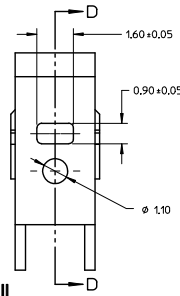
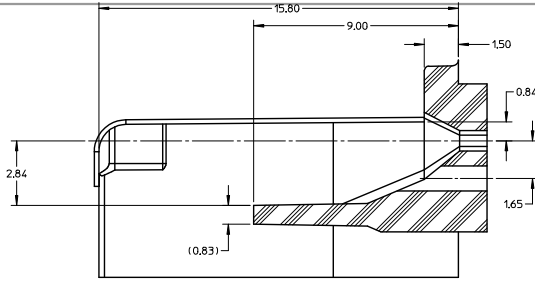
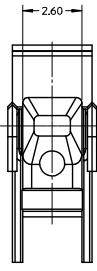

SECTION D-D TPA/INSERT DETAIL

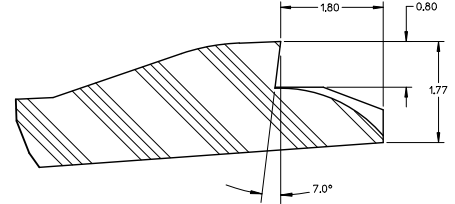
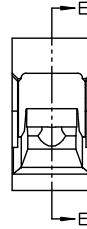
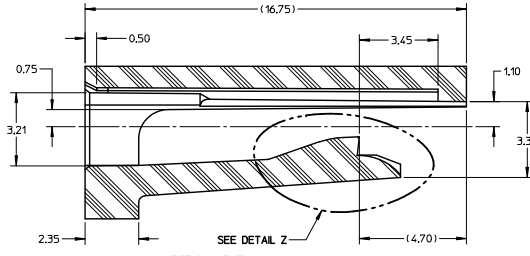
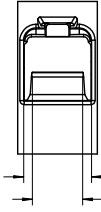

DETAIL Z SCALE 20:1

HOUSING DETAIL

NOTES: (UNLESS OTHERWISE SPECIFIED)

1. TOLERANCES: LINEAR  $\pm 0.10$   
ANGULAR  $3^\circ$
2. ALL DRAFT WITHIN TOLERANCE
3. MAX RADI ON ALL CORNERS SHOWN SHARP: 0.10
4. MAX FLASH PERMISSIBLE: 0.1
5. EJECTOR PIN MARKS PERMISSIBLE IF FLUSH TO 0.25 BELOW SURFACE
6. MATERIAL: HOUSING/PINGER SPECIFICATION ENGINEERED FOR MATERIAL WITH THE FOLLOWING PROPERTIES:  
A. FLEXURAL MODULUS = 4500 TO 9400 MPa  
PER ASTM TEST D790  
B. ELONGATION AT YIELD = 2.3% OR BETTER  
PER ASTM TEST D638 TYPE V
7. CAVITY SPEC FOR USE ONLY WITH MOLEX BLADE TERMINAL PART NUMBERS (EXCEPT PAYS FOR UNSEALED APPLICATIONS) SPECIFIED ELSEWHERE ON THIS DRAWING

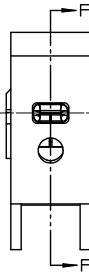
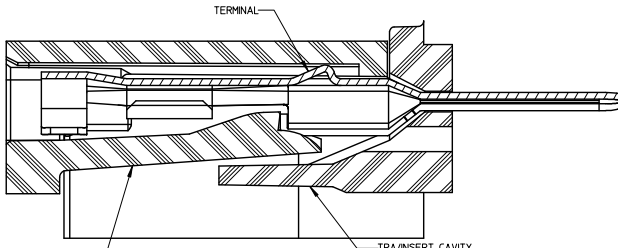
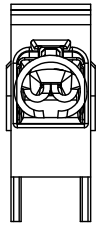

BLADE TERMINAL HOUSING CAVITY SECTION F-F TPA/INSERT CAVITY

BLADE CAVITY ASSEMBLY VIEWS

ENTER DESCRIPTION EC NO: 0402014-0473 DRAWN BY: JENNINGS01 2013/10/07 CHKD: APPROB: MOSER 2014/01/03 D REV	QUALITY SYMBOLS 0 0 0	GENERAL TOLERANCES (UNLESS SPECIFIED)		DIMENSION STYLE MM ONLY		SCALE	DESIGN UNITS	THIRD ANGLE PROJECTION		
		4 PLACES $\pm$ ---	---	---	---	---	METRIC	MX150 1.5MM BLADE TERMINAL		
		3 PLACES $\pm$ ---	---	---	---	---	---	MOLEX INCORPORATED		
		2 PLACES $\pm 0.1$	---	---	---	---	---	SD-33000-001		
1 PLACE $\pm 0.3$	---	---	---	---	---	MATERIAL NO. DOCUMENT NO.		SHEET NO.		
DRAFT WHERE APPLICABLE MUST REMAIN WITHIN DIMENSIONS		SEE TABLE		THIS DRAWING CONTAINS INFORMATION THAT IS PROPRIETARY TO MOLEX INCORPORATED AND SHOULD NOT BE USED WITHOUT WRITTEN PERMISSION		4 OF 5				

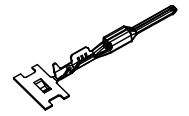

ISO VIEW  
SCALE 2:1

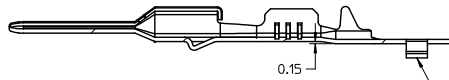
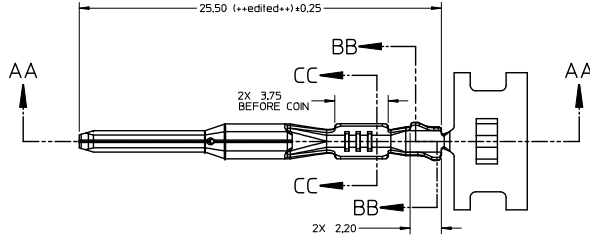
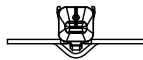
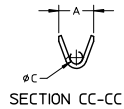
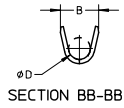

P/N'S 33000-0004/1004  
33011-2004/3004

CARRIER BUMP DIRECTION  
POINTS DOWN FOR TIN PLATED TERMINALS  
POINTS UP FOR PRECIOUS METAL PLATED  
TERMINALS

ENTER DESCRIPTION EC NO: 0402014-0473 DRAWN BY: JENNINGS01 2013/10/07 CHKD: APPARMOSEER 2014/01/03 APPR: MOSEER	QUALITY SYMBOLS ▽=0 ▽=0 ▽=0	GENERAL TOLERANCES (UNLESS SPECIFIED)		DIMENSION STYLE MM ONLY		SCALE 5:1	DESIGN UNITS METRIC	THIRD ANGLE PROJECTION		
		4 PLACES ± --- ± ---	mm INCH	DRAWN BY L. PULLIAM	DATE 2006/01/31	TITLE MX150 1.5MM BLADE TERMINAL				
		3 PLACES ± --- ± ---		CHECKED BY A. DHIR	DATE 2006/02/01	APPROVED BY B. MOSER				
		2 PLACES ± 0.1 ± --- 1 PLACE ± 0.3 ± --- ANGULAR ± 3°		APPROVED BY B. MOSER		DATE 2006/02/02	MOLEX INCORPORATED		SHEET NO. 5 OF 5	
DRAFT WHERE APPLICABLE MUST REMAIN WITHIN DIMENSIONS		SEE TABLE		MATERIAL NO.		DOCUMENT NO. SD-33000-001		THIS DRAWING CONTAINS INFORMATION THAT IS PROPRIETARY TO MOLEX INCORPORATED AND SHOULD NOT BE USED WITHOUT WRITTEN PERMISSION		