

Excellent Integrated System Limited

Stocking Distributor

Click to view price, real time Inventory, Delivery & Lifecycle Information:

[Molex Connector Corporation](#)
[0353620576](#)

For any questions, you can email us directly:

sales@integrated-circuit.com

10 9 8 7 6 5 4 3 2 1

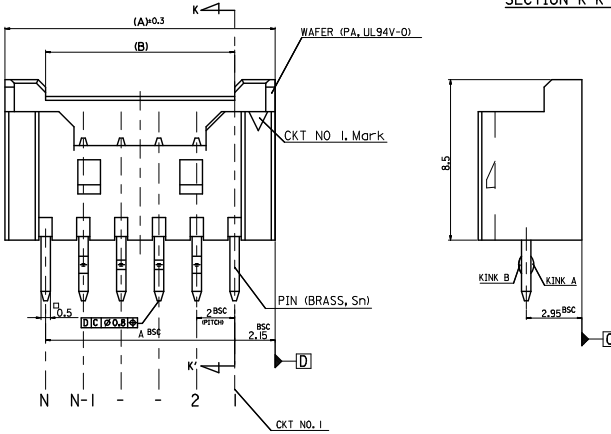
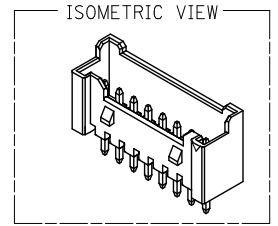
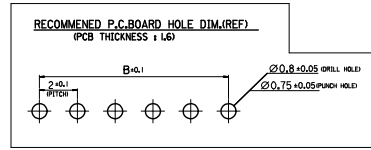
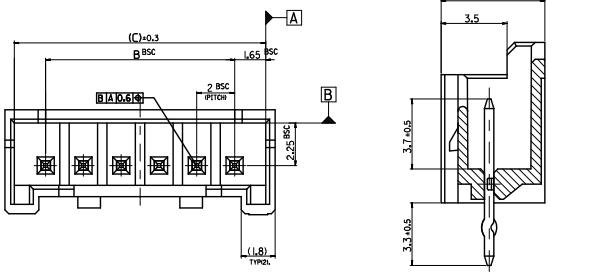

LEGEND

SD-35362-****
CKT NO. _____ COLOR _____

FINAL GOOD (BULK) — 5 : SELECTIVE KINK (LEAD FREE) (LEAD FREE)
— 6 : NONE KINK (LEAD FREE)

SUB ASSY (TUBE) — 7 : SELECTIVE KINK (LEAD FREE) (LEAD FREE)
— 8 : NONE KINK (LEAD FREE)

COLOR
0 : NATURAL
1 : BLACK
2 : RED
3 : YELLOW
4 : BLUE
5 : GREEN
6 : TUBE PACKING (Natural Color)
7 : TUBE PACKING (Red Color)
8 : TUBE PACKING (Blue Color)

NOTES

1. MATERIAL : UNFILLED POLYAMIDE, UL94V-0
FIN : BRASS
2. FINISHES : PIN : Ti/Sn 1-3µm OVERALL
3. PRODUCT SPECIFICATION : PS-35507-003
4. MATING HOUSING : 35507-***0*
5. MATING TERMINAL : 50212-8000
6. KINK

31.3	28	32.3	3536215**	35362-15**	I5
29.3	26	30.3	3536214**	35362-14**	I4
27.3	24	28.3	3536213**	35362-13**	I3
25.3	22	26.3	3536212**	35362-12**	I2
23.3	20	24.3	3536211**	35362-11**	I1
21.3	18	22.3	3536210**	35362-10**	I0
19.3	16	20.3	3536209**	35362-09**	9
17.3	14	18.3	3536208**	35362-08**	8
15.3	12	16.3	3536207**	35362-07**	7
13.3	10	14.3	3536206**	35362-06**	6
11.3	8	12.3	3536205**	35362-05**	5
9.3	6	10.3	3536204**	35362-04**	4

CKT NO	1	2	3	4	5	N-2	N-1	N
6 CKT OVER	-	A	B	-	-	B	A	-
5 CKT	A	B	-	B	A			
4 CKT	A	B	B	A				

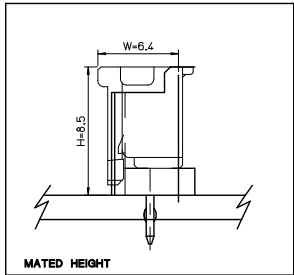

LEAD FREE

30 over	±0.3
10 over 30 under	±0.25
10 under	±0.2
ANGLE	±3°
GENERAL TOLERANCE	

REVISED
EC. NO. : KOR2015-0019
DRAWN BY : M01
CHKD BY : SKM
APPR : YJM

2014/08/25
2014/08/26
2014/09/03

QUALITY SYMBOLS

▽=0
▽=0
▽=0

GENERAL TOLERANCES (UNLESS SPECIFIED)

	mm	INCH
4 PLACES	±---	±---
3 PLACES	±---	±---
2 PLACES	±---	±---
1 PLACE	±---	±---
0 PLACE	±	±

ANGULAR ±---°
DRAFT WHERE APPLICABLE MUST REMAIN WITHIN DIMENSIONS

DIMENSION STYLE
MM ONLY

SCALE 5:1

DESIGN UNITS METRIC

THIRD ANGLE PROJECTION

2.0 W/B WAFER ASS'Y
-LEAD FREE-

molex

DOCUMENT NO. SD-35362-002

SHEET NO. 1 OF 1

9 8 7 6 5 4 3 2 1

10 9 8 7 6 5 4 3 2 1

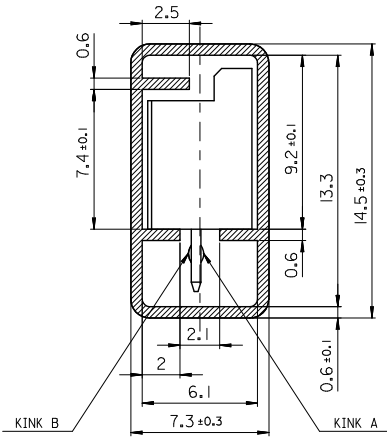
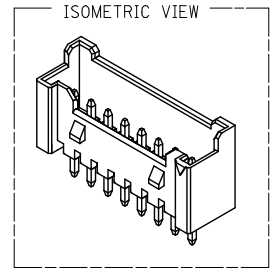
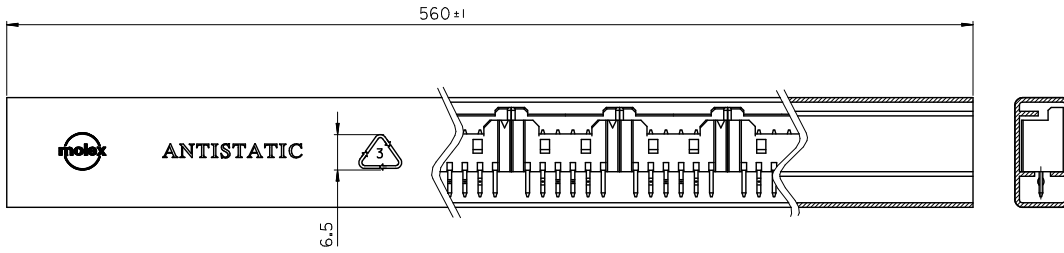

LEGEND.

E-35362-***

2-20 Circuits-CKT NO.

Final GOOD (Bulk) - 5: SELECTIVE KINK, 6: NONE KINK

Sub Assy (Tube) - 7: SELECTIVE KINK, 8: NONE KINK

Color & Packing

- 0: NATURAL
- 1: BLACK
- 2: RED
- 3: YELLOW
- 4: BLUE
- 5: GREEN
- 6: TUBE PACKING (Natural Color)
- 7: TUBE PACKING (RED Color)
- 8: TUBE PACKING (BLUE Color)

NOTES

1. MATERIAL : TUBE - TRANSLUCENT P.V.C (P-1000)
Wafer - POLYAMIDE, UL94V-0
PIN - BRASS SQ 0.5mm
2. BOW(CAMBER) : 1.0mm MAX./Total Length
3. DIMENSIONS GIVEN ACROSS CENTER LINES ARE SYMMETRICAL ABOUT THOSE CENTER LINES WITH HALF THE TOTAL LENGTH.
4. TOTAL TUBE LENGTH : 560mm + -1mm
5. TWIST : 5° MAX./Total Length
6. BURRS : 0.2mm MAX.
7. SKEW : PRODUCTS MUST BE FLOWED SMOOTHLY WHEN THIS STICK IS PLACES 30° ANGLE.
8. THICKNESS : 0.6mm + -0.1mm
9. ARTWORK : PER E-35900-0434 (SILK SCREEN COLOR : RED)
10. APPLICABLE STOPPER(RUBBER) : 35900-0435

TABLE

10	20**	-20**	20
10	19**	-19**	19
10	18**	-18**	18
10	17**	-17**	17
15	16**	-16**	16
15	15**	-15**	15
15	14**	-14**	14
15	13**	-13**	13
15	12**	-12**	12
20	11**	-11**	11
20	10**	-10**	10
25	09**	-09**	9
25	08**	-08**	8
30	07**	-07**	7
35	06**	-06**	6
40	05**	-05**	5
50	04**	-04**	4
60	03**	-03**	3
70	3536202**	35362-02**	2
QTY	Material NO.	ENG. NO.	CKT

KINK TABLE(FOR 35362-****)

CKT NO	1	2	3	4	5	N-2	N-1	N
6 CKT OVER	-	A	B	-	-	B	A	-
5 CKT	A	B	-	B	A	-	-	-
4 CKT	A	B	B	A	-	-	-	-
3 CKT	A	B	A	-	-	-	-	-
2 CKT	None Kink		-	-	-	-	-	-

** 35362-0287 IS ONLY KINKED 2P

CKT NO	1	2
PRODUCT NO.	A	B

LEAD FREE

REVISED EC NO. KOR2014-0116 DRW/KTK/M01 2014/04/14 CHKD: YSK/M02 APPR: YSK/M02 2014/04/21 REV	QUALITY SYMBOLS √=0 ∇=0 ∇=0	GENERAL TOLERANCES (UNLESS SPECIFIED) mm INCH 4 PLACES ± --- ± --- 3 PLACES ± --- ± --- 2 PLACES ± --- ± --- 1 PLACE ± 0.2 ± --- 0 PLACE ± --- ±	DIMENSION STYLE MM ONLY DRAWN BY DATE YSOOKIM 2000/12/11 CHECKED BY DATE JKOH 2000/12/11 APPROVED BY DATE	SCALE 5:1 DESIGN UNITS METRIC THIRD ANGLE PROJECTION	TITLE 2.0 W/B WAFER ASS'Y TUBE PACKING -LEAD FREE- molex	MATERIAL NO. 9999999999 DOCUMENT NO. SD-35362-003 SHEET NO. 1 OF 1
	DRAFT WHERE APPLICABLE WITHIN DIMENSIONS		THIS DRAWING CONTAINS INFORMATION THAT IS PROPRIETARY TO MOLEX INCORPORATED AND SHOULD NOT BE USED WITHOUT WRITTEN PERMISSION			

9 8 7 6 5 4 3 2 1