

Excellent Integrated System Limited

Stocking Distributor

Click to view price, real time Inventory, Delivery & Lifecycle Information:

[Molex Connector Corporation](#)
[0190560118](#)

For any questions, you can email us directly:

sales@integrated-circuit.com

FILE NO. **B-CD-301-01**

- NOTES:**
- ① MAT'L: COPPER (STOCK TKN. $\frac{.031}{.79}$)
PLATING: ELECTRO-TIN (.0003 MIN.)
 - ② BRAZED SEAM

STUD SIZES: ($\pm .005$)

- 02 = .094
- 04 = .119
- 06 = .146
- 08 = .173
- 10 = .198
- 14 = .265
- 56 = .328
- 38 = .390

"UL" LISTING # E32244
"CSA" LISTING # 18689

ALL DIMENSIONS = $\frac{\text{INCHES}}{\text{MM}}$

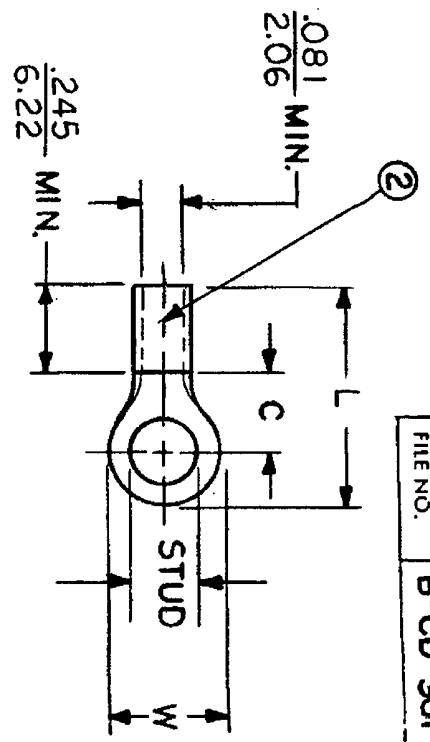

WIRE SIZE: 16-14 AWG
1.0-2.5 MM²

PART NUMBER	"W" ±.010	"C" MIN.	"L" MAX.	REFERENCE		AVAILABLE STUD SIZES
				SCALE:	NTS	
B-318-	$\frac{.534}{13.56}$	$\frac{.554}{14.07}$	$\frac{1.115}{28.32}$	DRWN. BY: JJ	DATE: 11-28-84	10, 14, 56, 38
B-323-	$\frac{.250}{6.35}$	$\frac{.209}{5.31}$	$\frac{.639}{16.23}$	CHKD. BY: GA	DATE: 11-30-84	02, 04, 06, 08
B-325-	$\frac{.467}{11.86}$	$\frac{.388}{9.86}$	$\frac{.916}{23.27}$	APPRD. BY:		10, 14, 56
B-337-	$\frac{.312}{7.92}$	$\frac{.285}{7.24}$	$\frac{.730}{18.54}$			04, 06, 08, 10
B-339-	$\frac{.342}{8.69}$	$\frac{.310}{7.87}$	$\frac{.775}{19.69}$			04, 06, 08, 10

DIMENSIONAL TOLERANCES UNLESS OTHERWISE SPECIFIED

FRAC. DEC. ANG.

SCALE: NTS
DRWN. BY: JJ
CHKD. BY: GA
APPRD. BY:

TITLE:
RING TONGUE
TERMINAL
VERSAKRIMP
300-SERIES



DWG. NO. **A** CUSTOMER DWG.