

Excellent Integrated System Limited

Stocking Distributor

Click to view price, real time Inventory, Delivery & Lifecycle Information:

[Molex Connector Corporation](#)

[0190570515](#)

For any questions, you can email us directly:

sales@integrated-circuit.com

FILE NO. B-CD-501-01

NOTES:

- ① MAT'L: COPPER (STOCK TKN. $\frac{.031}{.79}$)
- PLATING: ELECTRO TIN (.0003 MIN)
- ② TIN-PLATED BRASS FUNNEL FERRULE
- ③ NYLON INSULATION (COLOR CODED BLUE)

STUD SIZES: ($\pm .005$)

- 02 = .094
- 04 = .119
- 06 = .146
- 08 = .173
- 10 = .198
- 14 = .265
- 56 = .328
- 38 = .390

"UL" LISTING #E32244
 "CSA" LISTING #18689

WIRE SIZE: 16-14 AWG
 1.0-2.5 MM²

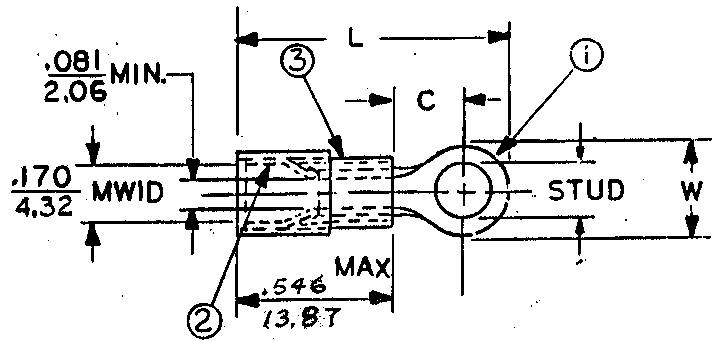

ALL DIMENSIONS = $\frac{\text{INCHES}}{\text{MM}}$ (MWID) = DENOTES MAXIMUM WIRE INSULATION DIAMETER

PART NUMBER	"W" $\pm .010$	"C" MIN.	"L" MAX.	AVAILABLE STUD SIZES
B-518-	$\frac{.534}{13.56}$	$\frac{.554}{14.07}$	$\frac{1.407}{35.74}$	10,14,56,38
B-523-	$\frac{.250}{6.35}$	$\frac{.209}{5.31}$	$\frac{.937}{23.65}$	02,04,06,08
B-525-	$\frac{.467}{11.86}$	$\frac{.388}{9.86}$	$\frac{1.208}{30.68}$	10,14,56
B-539-	$\frac{.342}{8.69}$	$\frac{.310}{7.87}$	$\frac{1.067}{27.10}$	04,06,08,10
B-537-	$\frac{.312}{7.92}$	$\frac{.285}{7.24}$	$\frac{1.022}{25.96}$	04,06,08,10

DIMENSIONAL TOLERANCES UNLESS OTHERWISE SPECIFIED			REFERENCE	SCALE: NTS	DATE	TITLE: RING TONGUE TERMINAL AVIKRIMP 500-SERIES		
FRAC.	DEC.	ANG.	REV. A 001/1830 11/6/93	DRWN. BY: Ho	11-12-84			
±	±	±		CHKD. BY: 6Z	11-30-84			
				APPRD. BY:				
							DWG. NO. A	CUSTOMER DWG.