

Excellent Integrated System Limited

Stocking Distributor

Click to view price, real time Inventory, Delivery & Lifecycle Information:

[Molex Connector Corporation](#)
[0190560037](#)

For any questions, you can email us directly:

sales@integrated-circuit.com



FILE NO. A-CD-301-01

- NOTES:**
- ① MAT'L: COPPER
PLATING: ELECTRO-TIN (.0003 MIN)
 - ② BRAZED SEAM

STUD SIZES: ($\pm .005$)

- 02 = .094
- 04 = .119
- 06 = .146
- 08 = .173
- 10 = .198
- 14 = .265
- 56 = .328
- 38 = .390

"UL" LISTING # E32244
 "CSA" LISTING # 18689

ALL DIMENSIONS = $\frac{\text{INCHES}}{\text{MM}}$

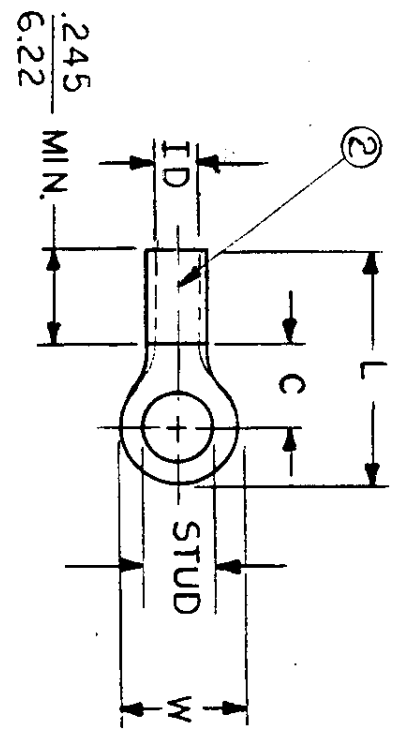

WIRE SIZE: 22-18 AWG
 .25-1.5 MM²

PART NUMBER	"W" ±.010	"C" MIN.	"L" MAX.	"ID" MIN.	AVAILABLE STUD SIZES	STOCK THICKNESS	DIMENSIONAL TOLERANCES UNLESS OTHERWISE SPECIFIED	
							FRAC.	DEC.
A-320-	.225 5.72	.157 3.99	.563 14.30	.062 1.57	02, 04, 06	.028 ^{+.001} .71	±	±
A-321-	.312 7.92	.270 6.86	.720 18.29	.062 1.57	06, 08, 10	.028 ^{+.001} .71	±	±
A-322-	.467 11.86	.386 9.80	.914 23.22	.062 1.57	10, 14, 56	.031 ^{+.001} .79	±	±
A-326-	.534 13.56	.552 14.02	1.113 28.27	.054 1.37	10, 14, 56, 38	.028 ^{+.001} .71	±	±
A-332-	.254 6.45	.240 6.10	.661 16.79	.062 1.57	04, 06, 08	.028 ^{+.001} .71	±	±

TITLE: RING TONGUE TERMINAL VERSAKRIMP 300 SERIES

SCALE: NTS

DATE: 11-28-64

CHKD. BY: GZ

APPRD. BY:

DWG. NO. A CUSTOMER DWG.