

Excellent Integrated System Limited

Stocking Distributor

Click to view price, real time Inventory, Delivery & Lifecycle Information:

[Molex Connector Corporation](#)
[0191540279](#)

For any questions, you can email us directly:

sales@integrated-circuit.com

10		9		8		7		6		5		4		3		2		19154	
LOOSE PIECE				TAPE MOUNTED				DIMENSIONS										COLOR	
MATERIAL NO.	ENGINEERING P/N	MATERIAL NO.	ENGINEERING P/N	MWID	OD (MAX)	L (MAX)	B (MAX)	ID (MIN)	H (NOM)										
191540004	A-245X	191540006	A-245XT	.150/3.81	.24/6.1	.97/24.6	.20/5.1	.060/1.52	.49/12.4	RED									
191540015	B-231X	191540017	B-231XT	.175/4.45	.27/6.9	.98/24.9	.24/6.1	.080/2.03	.49/12.4	BLUE									
191540028	C-246X	191540030	C-246XT	.260/6.60	.36/9.2	1.14/29.0	.30/7.6	.125/3.17	.43/10.9	YELLOW									

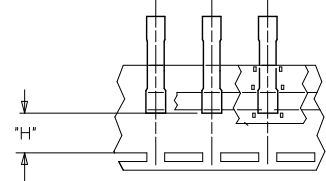
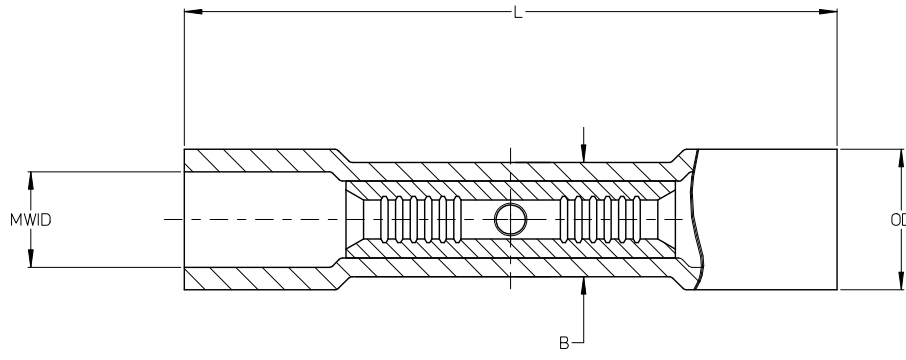

TAPE MOUNTED PARTS

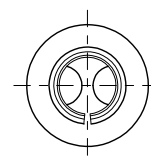

NOTES:

1. MATERIALS: PVC INSULATION OVER TIN-PLATED COPPER SPLICE.
2. COLOR: SEE CHART.
3. MWID = MAXIMUM WIRE INSULATION DIAMETER.
4. PARTS ARE ROHS COMPLIANT.

REDRAW EC NO: WNA2009-0865 DRAWN BY: ETHRODAHL 2009/07/09 CHECKED BY: JMACNEIL 2009/07/09 APPROVED BY: JMACNEIL 2009/07/09	QUALITY SYMBOLS ▽=0 ▽=0	GENERAL TOLERANCES (UNLESS SPECIFIED) <table border="1"> <tr> <th></th> <th>mm</th> <th>INCH</th> </tr> <tr> <td>4 PLACES</td> <td>± .13</td> <td>± .005</td> </tr> <tr> <td>3 PLACES</td> <td>± .13</td> <td>± .01</td> </tr> <tr> <td>2 PLACES</td> <td>± .13</td> <td>± .01</td> </tr> <tr> <td>1 PLACE</td> <td>± .25</td> <td>± .01</td> </tr> </table>		mm	INCH	4 PLACES	± .13	± .005	3 PLACES	± .13	± .01	2 PLACES	± .13	± .01	1 PLACE	± .25	± .01	DIMENSION STYLE IN/MM	SCALE 1:1	DESIGN UNITS INCH	THIRD ANGLE PROJECTION
		mm	INCH																		
	4 PLACES	± .13	± .005																		
	3 PLACES	± .13	± .01																		
2 PLACES	± .13	± .01																			
1 PLACE	± .25	± .01																			
DRAFT WHERE APPLICABLE MUST REMAIN WITHIN DIMENSIONS	DRAWN BY: ETHRODAHL 2009/06/23 CHECKED BY: JMACNEIL 2009/06/24 APPROVED BY: JMACNEIL 2009/06/24	DATE: 2009/06/23 DATE: 2009/06/24 DATE: 2009/06/24	TITLE BUTT SPLICE CONNECTOR, INSULKRIMP	MATERIAL NO. SEE CHART	DOCUMENT NO. SD-19154-006	SHEET NO. 1 OF 1															
THIS DRAWING CONTAINS INFORMATION THAT IS PROPRIETARY TO MOLEX INCORPORATED AND SHOULD NOT BE USED WITHOUT WRITTEN PERMISSION																					